



Jerrick Hernandez &lt;jhernandez@guamopa.com&gt;

---

**Re: Procurement Record - OPA-PA-24-002 (FINAL PART 3)**

---

**Pia A. Castro** <pacastro@portofguam.com>

Thu, Aug 22, 2024 at 10:46 AM

To: jhernandez &lt;jhernandez@guamopa.com&gt;

Cc: eservice &lt;eservice@rwtguam.com&gt;, jdwalsh &lt;jdwalsh@rwtguam.com&gt;, jrazzano &lt;jrazzano@rwtguam.com&gt;

Good morning

Attached for your information is the FINAL set, [Part 3](#), of documents pertaining to **Docket No. OPA-PA-24-002**.

Thank you,

Pia

**PIA A. CASTRO**

Procurement Admin. Officer

Port of Guam, Jose D. Leon Guerrero Commercial Port

1026 Cabras Hwy., Ste. 201, PITI, GU 96915

Tel: 1-671-477-5931 Ext: 253

---

**From:** "Pia A. Castro" <pacastro@portofguam.com>**To:** "jhernandez" <jhernandez@guamopa.com>**Cc:** "eservice" <eservice@rwtguam.com>, "jdwalsh" <jdwalsh@rwtguam.com>, "jrazzano" <jrazzano@rwtguam.com>**Sent:** Thursday, August 22, 2024 10:41:49 AM**Subject:** Procurement Record - OPA-PA-24-002 (PART 2)

Good morning

Attached for your information is [Part 2](#) of documents pertaining to **Docket No. OPA-PA-24-002**.

Thank you,

Pia

**PIA A. CASTRO**

Procurement Admin. Officer

Port of Guam, Jose D. Leon Guerrero Commercial Port

1026 Cabras Hwy., Ste. 201, PITI, GU 96915

Tel: 1-671-477-5931 Ext: 253

**From:** "Pia A. Castro" <pacastro@portofguam.com>  
**To:** "jhernandez" <jhernandez@guamopa.com>  
**Cc:** "eservice" <eservice@rwtguam.com>, "jdwalsh" <jdwalsh@rwtguam.com>, "jrazzano" <jrazzano@rwtguam.com>  
**Sent:** Thursday, August 22, 2024 10:39:47 AM  
**Subject:** Procurement Record - OPA-PA-24-002 (PART 1)

Good morning Jerrick,

Attached for your information is **Part 1** of documents pertaining to **Docket No. OPA-PA-24-002**.

Thank you,

Pia















**PIA A. CASTRO**

Procurement Admin. Officer  
Port of Guam, Jose D. Leon Guerrero Commercial Port  
1026 Cabras Hwy., Ste. 201, PITI, GU 96915  
Tel: 1-671-477-5931 Ext: 253

---

























**24 attachments**

-  **1a Procurement Planning Docs.pdf**  
1500K
-  **1b Procurement Planning Docs.pdf**  
1893K
-  **1c Requisition 21658 ON.pdf**  
43K
-  **1d Request GSA Availability.pdf**  
33K
-  **1e Boom lift specification.pdf**  
104K
-  **1f Determinations Required by Law.pdf**  
117K
-  **2a Ad IFB PAG 004-24 Proof\_Invoice.pdf**  
119K
-  **2b Ad Block - Guam Post Jan26 2024.pdf**  
721K
-  **3AIFBP~1.PDF**  
2273K
-  **3b Amendment No. 1 IFB-PAG-004-24.pdf**  
45K
-  **4a Far East Equipment Questions.pdf**  
52K
-  **4b Moricco Questions IFB-PAG-004-24.pdf**  
243K

-  **4c Q&C Response IFB-PAG-004-24.pdf**  
46K
-  **5a Bid Opening - Feb16 2024.mp3**  
12767K
-  **5b Morrico Submittal.pdf**  
11868K
-  **6a Letter to Morrico- Bid Status.pdf**  
68K
-  **6BLETT~1.PDF**  
40K
-  **7a Procurement Protest March 5 2024.pdf**  
49K
-  **7b Amended Protest.pdf**  
64K
-  **7CNOTI~2.PDF**  
44K
-  **7DDETE~1.PDF**  
30K
-  **7ENOTI~1.PDF**  
30K
-  **8a Email Communication.pdf**  
2113K
-  **8BEMAI~1.PDF**  
214K

## **ORIGINAL BID - IFB PAG 004-024 180' Telescopic Boom Lift**

### **(Email Part 3) Record of Planning Documents:**

-  1a Procurement Planning Docs
-  1b Procurement Planning Docs
-  1c Requisition 21658 ON
-  1d Request GSA Availability
-  1e Boom lift specification
-  1f Determinations Required by Law
-  2a Ad IFB PAG 004-24 Proof\_Invoice
-  2b Ad Block - Guam Post Jan26 2024
-  3a IFB PAG 004-024 180 Telescopic Boom Lift
-  3b Amendment No. 1 IFB-PAG-004-24
-  4a Far East Equipment Questions
-  4b Moricco Questions IFB-PAG-004-24
-  4c Q&C Response IFB-PAG-004-24
-  5a Bid Opening - Feb16 2024
-  5b Morricco Submittal
-  6a Notice of Rejection of Bid
-  6b Letter\_ Surface Solutions IFB PAG 004 24
-  7a Procurement Protest March 5 2024
-  7b Amended Protest
-  7c Notice of Cancellation to All Registered Bidders
-  7d Determination of Rejection and Cancellation
-  7e Notice of Cancellation to AGO Transmittal
-  8a Email Communication
-  8b Email Comm - Amend 1 & Q&C distribution

1a



**PORT OF GUAM**  
 ATURIDAT I PUETTON GUAHAN  
 Jose D. Leon Guerrero Commercial Port  
 1026 Cabras Highway, Suite 201, Piti, Guam 96915  
 Telephone: 671-477-5931/35 Facsimile: 671-477-2689/4445  
 Website: www.portguam.com



Lourdes A. Leon Guerrero  
 Governor of Guam  
 Joshua F. Tenorio  
 Lieutenant Governor

**RECEIVED**  
 General Manager's Office  
 Port Authority of Guam  
 Port Of Guam  
 Jose D. Leon Guerrero Commercial Port

OCT 25 2023 PM 12:09  
 Received  
 Procurement and Supply Division

October 24, 2023

**INTER-OFFICE MEMORANDUM**

**TO:** General Manager  
**Via:** Procurement & Supply Manager  
**From:** Program Coordinator II  
**Subject:** **180' Telescopic Boom Lift**

*Handwritten signature: J. M. G. Soble*

Transmitted for your review are the following documents for the procurement of a telescopic boom lift:

1. Requisition #21658 ON
2. Determination of Need
3. Transmittal of Planning Procurement Record to PAG Procurement
4. AG Form 014 - Declaration Re Compliance with 5 GCA § 5150
5. Market Research Survey
6. Scope of Services (signed by End-User/Division Head)
7. Scope of Services Soft Copy e-mailed to Procurement
8. Advertisement BPA PDN or Daily Post (Procurement)
9. Communication Log (Includes email copies or any other correspondence record)

Thank you in advance for your continued support in our efforts to secure the procurement of much needed E1 Technician Consultant.

Should you have any questions or need more information, please feel free to contact me.

Si Yu'as Ma'ase

*Handwritten signature of Jacqueline Cruz*  
 Jacqueline Cruz

[ ] Concur:  
*Handwritten signature of Rory J. Respicio*

Rory J. Respicio

Order Company 00050 Order Number 21658 000 ON  
 Branch/Plant PAG01  
 Shipped From Port Authority of Guam Ship To Port Authority of Guam  
 1026 Cabras Highway 1026 Cabras Hwy, Ste 201  
 Piti GU 96925 Piti GU

Ordered 10/23/2023 Freight  
 Requested 10/23/2023 Order Taken By Currency Code  
 Delivery URGENTLY NEED

Line	Rev	Description /Supplier Item	Ordered	UOM	Unit Price	PU UM	Extended Price	Request Date	Order No	Ty
1.000	0	TELESCOPIC BOOM LIFT	1	EA	655,500.0000	EA	655,500.00	10/23/2023		

TELESCOPIC BOOM LIFT, 180' REACH FULL TIME 4WD

PLEASE SEE ATTACHED BID SPECIFICATIONS AND OTHER DOCUMENTS.

POC: JACQUE CRUZ, RAYMOND SANTOS (671)477-5931/5 EXTENSIONS 295 OR 294.

Total Order 655,500.00  
 Total Order

Term Net Due - 30 Days Tax Rate \*NA\* .00 655,500.00



**Reqs.Awaiting Approval -  
Work With Approval Status Summary**

Personal Form: (No Personalization) ▾ Layout: (No Layout) ▾ Query: All Records

Tools One View

Order Number

Records 1 - 7



<input type="checkbox"/>	Approval Route Code	Person Responsible	Status	Released Date	Released Time
<input checked="" type="radio"/>	PAG10	<b>Budget Approver</b>	Approved	10/23/2023	145506
<input type="radio"/>	PAG10	SANTOS, RAYMOND B.	Approved	10/23/2023	152325
<input type="radio"/>	PAG10	NELSON, GLENN B.	Approved	10/23/2023	152430
<input type="radio"/>	PAG10	BAMBA, VINCENT C.	Approved	10/23/2023	152709
<input type="radio"/>	PAG10	PAG Buyer Supervisor	Approved	10/24/2023	83548
<input type="radio"/>	PAG10	PAG Buyer Manager	Approved	10/24/2023	110047
<input type="radio"/>	PAG10	RESPICIO, RORY J.	Approved	10/24/2023	141318





## DETERMINATION OF NEED

### 180' Boom Lift

The Port Authority of Guam operates the only commercial seaport on Territory and as the primary seaport in Micronesia, serves as a transshipment port for the entire Western Pacific Region. It operates the largest U.S. deep water seaport in the Western Pacific Region and currently handles over 2 million tons of cargo a year. The Port owns, operates and maintains various cargo handling equipment to move cargoes and to support the maintenance of other cargo handling equipment's.

The Port Authority of Guam's Maintenance Department requires a 180-foot boom lift for various types of maintenance. This is the only possible way for Facility Maintenance to repair all high mast lighting for the entire terminal yard. The lift provides maintenance to access unreachable areas on our 3 Gantry Cranes for any corrosion and welding repairs. Without the ability to conduct such repairs would reduce the life span of our already aging cranes and cause significant safety concerns.



---

Rory J. Resepcio, General Manager



---

Date

# TRANSMITTAL OF PLANNING PROCUREMENT RECORD TO GSA

**Instructions:** After ascertaining the statement's accuracy and truthfulness, the agency's (director or head of agency) must sign the Certification below to indicate that the agency has kept and will keep a complete procurement record of all documents required by law as to its planning of the procurement; and is in fact transmitting a full and complete record of the planning of the procurement to GSA in accompaniment with this transmittal form as of the date this form is signed.

**Requesting/Using Agency:** Port Authority of Guam

**Re:** Telescopic Boom Lift, 180' feet Reach Full time 4WD

## 5 GCA §5249 Record of Procurement Actions

Each procurement officer shall maintain a complete record of each procurement. The record shall include the following:

- (a) the date, time, subject matter and names of participants at any meeting including government employees that is in any way related to a particular procurement;
- (b) a log of all communications between government employees and any member of the public, potential bidder, vendor or manufacturer which is in any way related to the procurement;
- (c) sound recordings of all pre-bid conferences; negotiations arising from a request for proposals and discussions with vendors concerning small purchase procurement;
- (d) brochures and submittals of potential vendors, manufacturers or contractors, and all drafts, signed and dated by the draftsman, and other papers or materials used in the development of specifications; and
- (e) the requesting agency's determination of need.

## 5 GCA §5132. Retention of Electronic Mail Correspondences

All incoming and outgoing electronic mail (email) correspondences pertaining to matters related to the procurement of goods and services as governed by this Chapter shall be retained for a period of not less than five (5) years. Such electronic mail (email) correspondences may be used for evidentiary purposes in the appellate procedures contained in this Chapter.

## 5 GCA § 10102 (d). Definition of Public Records

Public Records includes any writing containing information relating to the conduct of public business prepared, owned, used, or retained by any state or local agency in any format, including in electronic format.

The specifications for this procurement were prepared by Joaquin P. Pangelinan in keeping with the above and all applicable Guam Procurement Laws and Regulations; and, he/she/they have included all records, meeting notes and any other materials in their/its possession in developing the specifications/statement of work/scope of services/technical specification as well as any of the above procurement records items. Additionally included is the written determination of need of the need the agency for this procurement (signed by director or head of the agency) and if applicable the board or commission minutes of the approval of this procurement. Please include research as to the availability of services, market availability. In the event this procurement is funded in whole or in part with federal funds a copy of the notice of grant award and any required federal terms and conditions or forms.

**CERTIFICATION:** I hereby certify under penalty of perjury that I am responsible for the planning procurement record and I have caused to be prepared and now transmit a full and complete record of the planning procurement records as required by law. I have obtained the signed verification of all individuals involved as the preparation of the specification that this is a true and accurate statement, and that this transmittal to GSA is complete. I acknowledge that there are continuing responsibilities within the requesting/using agency as to public records related to this procurement and will make sure they are maintained as required above.

Signature: \_\_\_\_\_

Print Name: Joaquin P. Pangelinan

Date: Oct 24, 23

**DECLARATION RE COMPLIANCE WITH 5 GCA § 5150**

I, RORY J. RESPICIO, make this declaration on 10/23/2023  
*[print name clearly]* *[enter today's date]*  
regarding Procurement No. REQ#: 21658-ON, and do hereby **certify under penalty of perjury** that:  
*[enter procurement no.]*

(1) I am the procurement officer (Chief Procurement Officer; Director of Public Works; or head of a purchasing agency) for this procurement;

(2) I have caused an estimate to be made of the cost of the services or supplies being procured, and for which a contract will be entered into or a purchase order will be issued, whichever is appropriate as the case may be;

(3) My estimate of the total cost of the contract or purchase order, whichever is appropriate as the case may be, is *[please check one]*:

less than \$500,000; or

\$500,000 or more;

(4) If the total estimated cost of the procurement is \$500,000 or more, I understand that I must be advised by legal counsel designated by the Attorney General (which may be an Assistant Attorney General or other legal counsel designated as Special Assistant Attorney General ("SAAG") under 5 GCA § 5150) during each and every phase of the procurement process, beginning with the planning stage and before any request for proposal or invitation to bid is issued or notice published, or before any sole source procurement or emergency procurement is undertaken;

(5) If the total estimated cost of the procurement is \$500,000 or more, I understand I may not proceed with any phase of the procurement unless I have been advised by an Assistant Attorney General or a SAAG to proceed;

(6) If the total estimated cost of the procurement is less than \$500,000 initially when the procurement is begun, but the total cost increases to \$500,000 or more at some later point in time, I understand I must contact the Attorney General's Office as soon as I become aware that the procurement will actually cost \$500,000 or more, and that I may not proceed further without the assistance of the Attorney General's Office or a SAAG; and

(7) I understand if I do not comply with the requirements of 5 GCA § 5150 and the Attorney General's Office or a SAAG has not acted as legal counsel during all phases of a procurement estimated to cost \$500,000 or more, the Attorney General or SAAG may disapprove the contract, or the procurement may be subject to cancellation, or any award, contract or purchase order made or entered into may be subject to termination.

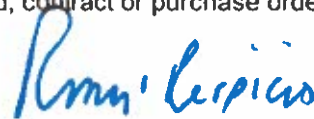

RORY J. RESPICIO

*[Declarant's Signature]*

## **180' Boom Lift Activity log**

September 18, 23 – Sent Mark Market Survey for approval

- Sent Ray Bamba email checking if GSA had any 180' Boom Lift available

September 19, 23 – Sent out Market Survey to

- Hawthorne
- Morrigo
- Far east
- LMS

September 26, - follow up calls to

- Morrigo
- Hawthorne
- LMS

October 2, followed up calls to

- Hawthorne
- Received Morrigo Market Survey

October 3, 23

- received response from Hawthorne
- received Morrigo BABAA document

October 5, 23 – received Morrigo Estimated cost

October 12, 23 – received LMS market Survey

October 20, 23 – received Signed Specifications from DPW

**Zimbra****jppangelinan@portofguam.com**

---

**180' Boom Lift Survey**

---

**From :** Joaquin P. Pangelinan  
<jppangelinan@portofguam.com>

Mon, Sep 18, 2023 02:44 PM

**Subject :** 180' Boom Lift Survey

**To :** Raymond Bamba <raymond.bamba@gsa.guam.gov>

**Cc :** Evelyn G. Pangelinan  
<egpangelinan@portofguam.com>

Good Afternoon Ray,  
Researching/Sourcing for a New 180' Boom Lift, does GSA have such equipment in stock?

Respectfully  
Joaquin P. Pangelinan  
Manager Equipment Support Services  
Maintenance Department  
Port Authority of Guam  
1026 Cabras Highway, Ste. 201 Piti, GU 96925  
Phone (671)477-5931 ex. 223  
jppangelinan@portofguam.com

---

Zimbra

jppangelinan@portofguam.com

**Re: Boom Lift Market Survey**

**From :** Patrick Chargualaf <Patrick@morricoequipment.com> Thu, Oct 05, 2023 08:05 AM  
**Subject :** Re: Boom Lift Market Survey   
**To :** Joaquin P. Pangelinan <jppangelinan@portofguam.com>  6 attachments  
**Cc :** Ross Morrison <Ross@morricoequipment.com>, Jesse Munoz <Jesse.Munoz@morricoequipment.com>

On Market Survey, page 8, cost \$ 640,500.00

Regards,

Patrick Mafnas Chargualaf  
Generator and Equipment Sales  
Morrico Equipment

+1 (671) 649-1946 Office  
+1 (671) 649-1947 Fax  
+1 (671) 688-0309 Cell



<http://www.morricoequipment.com>

**IMPORTANT:** The sender intends that this electronic message is for exclusive use by the person to whom it is addressed. This message may contain information that is confidential or privileged and exempt from disclosure under applicable law. If the reader of this message is not an intended recipient, be aware that any disclosure, dissemination, distribution or copying of this communication, or the use of its contents, is prohibited. If you have received this message in error, please immediately notify the sender of your inadvertent receipt and delete this message from all data storage systems. Thank you

---

**From:** Joaquin P. Pangelinan <jppangelinan@portofguam.com>  
**Sent:** Thursday, October 5, 2023 8:03 AM  
**To:** Patrick Chargualaf <Patrick@morricoequipment.com>  
**Cc:** Ross Morrison <Ross@morricoequipment.com>; Jesse Munoz <Jesse.Munoz@morricoequipment.com>  
**Subject:** Re: Boom Lift Market Survey

Good Morning Pat,  
Thanks for the document, any idea of cost?  
Kin

---

**From:** "patrick" <Patrick@morricequipment.com>  
**To:** "Joaquin Pangelinan" <jppangelinan@portofguam.com>  
**Cc:** "Ross Morrison" <Ross@morricequipment.com>, "Jesse Munoz" <Jesse.Munoz@morricequipment.com>  
**Sent:** Wednesday, October 4, 2023 5:06:28 PM  
**Subject:** Re: Boom Lift Market Survey

Kin,

Good evening.

Attached sample COO From JLG for review.

Please advise if sufficient for BAA certification.

Regards,

Patrick Mafnas Chargualaf  
Generator and Equipment Sales  
Morrice Equipment

+1 (671) 649-1946 Office  
+1 (671) 649-1947 Fax  
+1 (671) 688-0309 Cell



<http://www.morricequipment.com>

**IMPORTANT:** The sender intends that this electronic message is for exclusive use by the person to whom it is addressed. This message may contain information that is confidential or privileged and exempt from disclosure under applicable law. If the reader of this message is not an intended recipient, be aware that any disclosure, dissemination, distribution or copying of this communication, or the use of its contents, is prohibited. If you have received this message in error, please immediately notify the sender of your inadvertent receipt and delete this message from all data storage systems. Thank you



---

**From:** Patrick Chargualaf <Patrick@morricoequipment.com>  
**Sent:** Monday, October 2, 2023 5:57 PM  
**To:** Joaquin P. Pangelinan <jppangelinan@portofguam.com>  
**Cc:** Ross Morrison <Ross@morricoequipment.com>; Jesse Munoz <Jesse.Munoz@morricoequipment.com>  
**Subject:** Re: Boom Lift Market Survey

Kin,

Hafa Adai and good evening.

Apologies this is late.

Please see attached and kindly reply with any questions or concerns.

Regards,

Patrick Mafnas Chargualaf  
Generator and Equipment Sales  
Morrico Equipment

+1 (671) 649-1946 Office  
+1 (671) 649-1947 Fax  
+1 (671) 688-0309 Cell



<http://www.morricoequipment.com>

**IMPORTANT:** The sender intends that this electronic message is for exclusive use by the person to whom it is addressed. This message may contain information that is confidential or privileged and exempt from disclosure under applicable law. If the reader of this message is not an intended recipient, be aware that any disclosure, dissemination, distribution or copying of this communication, or the use of its contents, is prohibited. If you have received this message in error, please immediately notify the sender of your inadvertent receipt and delete this message from all data storage systems. Thank you

---

**From:** Joaquin P. Pangelinan <jppangelinan@portofguam.com>  
**Sent:** Tuesday, September 26, 2023 9:15 AM  
**To:** Patrick Chargualaf <Patrick@morricoequipment.com>  
**Subject:** Re: Boom Lift Market Survey

thanks Pat

---

**From:** "patrick" <Patrick@morricequipment.com>  
**To:** "Joaquin Pangelinan" <jppangelinan@portofguam.com>  
**Sent:** Tuesday, September 26, 2023 8:29:41 AM  
**Subject:** Re: Boom Lift Market Survey

Kin,

Have budget number and lead time and sending latest tomorrow.

Regards,

Patrick Mafnas Chargualaf  
Generator and Equipment Sales  
Morrice Equipment

+1 (671) 649-1946 Office  
+1 (671) 649-1947 Fax  
+1 (671) 688-0309 Cell



<http://www.morriceequipment.com>

IMPORTANT: The sender intends that this electronic message is for exclusive use by the person to whom it is addressed. This message may contain information that is confidential or privileged and exempt from disclosure under applicable law. If the reader of this message is not an intended recipient, be aware that any disclosure, dissemination, distribution or copying of this communication, or the use of its contents, is prohibited. If you have received this message in error, please immediately notify the sender of your inadvertent receipt and delete this message from all data storage systems. Thank you

---

**From:** Joaquin P. Pangelinan <jppangelinan@portofguam.com>  
**Sent:** Tuesday, September 26, 2023 8:28 AM  
**To:** Patrick Chargualaf <Patrick@morriceequipment.com>  
**Subject:** Re: Boom Lift Market Survey

Good Morning Pat,  
Following up on 180' Boom List market Survey.  
Thanks,  
Kin

---

**From:** "Joaquin Pangelinan" <jppangelinan@portofguam.com>  
**To:** "patrick" <Patrick@morricequipment.com>  
**Sent:** Wednesday, September 20, 2023 12:26:15 PM  
**Subject:** Re: Boom Lift Market Survey

Thanks Pat

---

**From:** "patrick" <Patrick@morricequipment.com>  
**To:** "Joaquin Pangelinan" <jppangelinan@portofguam.com>  
**Cc:** "Jesse Munoz" <Jesse.Munoz@morricequipment.com>  
**Sent:** Wednesday, September 20, 2023 12:11:52 PM  
**Subject:** Re: Boom Lift Market Survey

Kin,

Received and thank you.

I'll revalidate previous proposal and send ASAP.

Regards,

Patrick Mafnas Chargualaf  
Generator and Equipment Sales  
Morrice Equipment

+1 (671) 649-1946 Office  
+1 (671) 649-1947 Fax  
+1 (671) 688-0309 Cell



<http://www.morriceequipment.com>

**IMPORTANT:** The sender intends that this electronic message is for exclusive use by the person to whom it is addressed. This message may contain information that is confidential or privileged and exempt from disclosure under applicable law. If the reader of this message is not an intended recipient, be aware that any disclosure, dissemination, distribution or copying of this communication, or the use of its contents, is prohibited. If you have received this message in error, please immediately notify the sender of your inadvertent receipt and delete this message from all data storage systems. Thank you

---

**From:** Joaquin P. Pangelinan <jppangelinan@portofguam.com>

**Sent:** Wednesday, September 20, 2023 12:07 PM  
**To:** Patrick Chargualaf <patrick@morricequipment.com>  
**Subject:** Boom Lift Market Survey

Good Morning Patrick,  
Sent this to Angel(not sure he's still there), so also sending to you.

Attached is a Market Survey for a 180' Boom Lift, please complete and return as soon as possible.

Respectfully  
Joaquin P. Pangelinan  
Manager Equipment Support Services  
Maintenance Department  
Port Authority of Guam  
1026 Cabras Highway, Ste. 201 Piti, GU 96925  
Phone (671)477-5931 ex. 223  
jppangelinan@portofguam.com

---

 **Market Survey; 180 Boom Lift - Morrico Equipment submitted 2 Oct 2023.pdf**  
277 KB

---



## CERTIFICATE OF ORIGIN

**DATE:** 12/13/2022

**TRADE NAME** JLG Industries, Inc.      **YEAR:** xxx

**MODEL:** 1850SJ Boom Lift      **SERIAL NO:** xxxxxxxx

**To Whom It May Concern:**

**JLG hereby declares that the goods purchased from JLG Industries, Inc.,  
McConnellsburg, PA have been manufactured in the United States and are products of  
the United States of America.**

**By: Alyssa Xu**  
Sales Analyst



**PORT OF GUAM**  
ATURIDAT I PUEYTON GUAHAN  
Jose D. Leon Guerrero Commercial Port  
1026 Cabras Highway, Suite 201, Piti, Guam 96915  
Telephone: 671-477-5931/35 Facsimile: 671-477-2689/4445  
Website: [www.portguam.com](http://www.portguam.com)



Lourdes A. Leon Guerrero  
Governor of Guam  
Joshua F. Tenorio  
Lieutenant Governor

**Market Research Survey**  
**180' Telescopic Boom Lift**  
**September 18, 2023**

**COMPANY NAME:**       Morrico Equipment      

Hafa Adai yan Buenas!

The Port Authority of Guam is interested in Purchasing a New Telescopic Boom Lift. We will be looking to purchase a Boom Lift with a reach of 180 feet and 750 lbs. Basket Capacity. We have a few requirements for Boom Lift. Below is a list of survey questions that we are requesting responses for. *(please refer to the non-disclosure agreement below)*

1. Is your Company an authorized service provider/dealer/ distributor for a Telescopic Boom Lift Manufacturer?
  - Yes, JLG
  
2. Does your company offer the above equipment and does it meet the Build American Buy American Act(BABAA).
  - Yes
  
3. Will your company be able a Build America Buy America Act Certificate from the manufacturer?
  - To be Confirmed
  
4. Does your company stock parts for said Boom Lifts?
  - Yes
  
5. What would your delivery time be for said Boom Lift?
  - 12 to 14 months
  
6. If you can supply unit, what are Warranty options?
  - Manufacturer's standard "1 and 5 Years"
  
7. Does your company employ certified technicians with proprietary software to troubleshoot, diagnose, repair Boom Lifts?
  - Yes

8. At what price range can you offer New Boom Lift? (optional, see non-disclosure agreement below)

- \$ 640,500.00 USD

Digitally signed by Patrick Muñoz Chargualaf  
DN: cn=Patrick Muñoz Chargualaf, o=Merica  
Generator and Equipment Sales,  
email=patrick.guarino@equipment.com, (c=US)  
Date: 2023.10.02 17:56:13 +1000

NAME OF INDIVIDUAL WHO COMPLETED THIS SURVEY: Patrick Chargualaf, Jesse Munoz, Ross Morrison

We thank you for your taking the time to complete this survey. Please forward your responses to [jppangelinan@portguam.com](mailto:jppangelinan@portguam.com) or [epbagaforo@portguam.com](mailto:epbagaforo@portguam.com)

The above website is for sample purposes only and not indicative of any budgetary or cost that the Port relies on.

Thank you for your taking the time to complete this survey. Please forward your responses to [pagprocurement@portofguam.com](mailto:pagprocurement@portofguam.com), [algsablan@portofguam.com](mailto:algsablan@portofguam.com), [macabrera@portofguam.com](mailto:macabrera@portofguam.com), [jppangelinan@portofguam.com](mailto:jppangelinan@portofguam.com), [egpangelinan@portofguam.com](mailto:egpangelinan@portofguam.com). *Non-disclosure Agreement: The purpose of this market research survey is to gauge the current market for the above services request, and to establish a budgetary amount. All information provided to the Port of Guam shall be kept strictly confidential and will not be shared, used, or distributed without written consent. The Port Authority of Guam will only use the information for the procurement planning and acquisition of the above request services. Taking this survey is completely optional and you have every right to refuse completing it. However, the information you provide will assist the Port Authority of Guam prepare the most effective method of procuring these services. The Port Authority of Guam promotes a fair and transparent procurement process and encourages all to participate.*

**Zimbra****jppangelinan@portofguam.com**

---

**Re: Boom Lift Market Survey**

---

**From :** Joaquin P. Pangelinan  
<jppangelinan@portofguam.com>

Tue, Sep 26, 2023 08:31 AM

**Subject :** Re: Boom Lift Market Survey

**To :** John Limtiaco <jlimtiaco@pacificunlimitedguam.com>

Good Morning John,  
Following up on 180' Boom List Market Survey.  
Thanks,  
Kin

---

**From:** "Joaquin Pangelinan" <jppangelinan@portofguam.com>  
**To:** "John Limtiaco" <jlimtiaco@pacificunlimitedguam.com>  
**Cc:** "Evelyn G. Pangelinan" <egpangelinan@portofguam.com>  
**Sent:** Tuesday, September 19, 2023 9:22:28 AM  
**Subject:** Boom Lift Market Survey

Good Morning John,

Attached is a Market Survey for a 180' Boom Lift, please complete and return as soon as possible.

Respectfully  
Joaquin P. Pangelinan  
Manager Equipment Support Services  
Maintenance Department  
Port Authority of Guam  
1026 Cabras Highway, Ste. 201 Piti, GU 96925  
Phone (671)477-5931 ex. 223  
jppangelinan@portofguam.com

---





**PORT OF GUAM**  
ATURIDATI PUEY, ÑON GUAHAN  
**Jose D. Leon Guerrero Commercial Port**  
1026 Cabras Highway, Suite 201, Piti, Guam 96915  
Telephone: 671-477-5931/35 Facsimile: 671-477-2689/4445  
Website: [www.portguam.com](http://www.portguam.com)



**Lourdes A. Leon Guerrero**  
Governor of Guam  
**Joshua F. Tenorio**  
Lieutenant Governor

**Market Research Survey**  
**180' Telescopic Boom Lift**  
**September 18, 2023**

**COMPANY NAME:** \_\_\_\_\_

Hafa Adai yan Buenas!

The Port Authority of Guam is interested in Purchasing a New Telescopic Boom Lift. We will be looking to purchase a Boom Lift with a reach of 180 feet and 750 lbs. Basket Capacity. We have a few requirements for Boom Lift. Below is a list of survey questions that we are requesting responses for. *(please refer to the non-disclosure agreement below)*

1. Is your Company an authorized service provider/dealer/ distributor for a Telescopic Boom Lift Manufacturer?
2. Does your company offer the above equipment and does it meet the Build American Buy American Act(BABAA).
3. Will your company be able a Build America Buy America Act Certificate from the manufacturer?
4. Does your company stock parts for said Boom Lifts?
5. What would your delivery time be for said Boom Lift?
6. If you can supply unit, what are Warranty options?
7. Does your company employ certified technicians with proprietary software to troubleshoot, diagnose, repair Boom Lifts?
8. At what price range can you offer New Boom Lift? (optional, see non-disclosure agreement below)

NAME OF INDIVIDUAL WHO COMPLETED THIS SURVEY: \_\_\_\_\_

We thank you for your taking the time to complete this survey. Please forward your responses to [jppangelinan@portguam.com](mailto:jppangelinan@portguam.com) or [epbagaforo@portguam.com](mailto:epbagaforo@portguam.com)

The above website is for sample purposes only and not indicative of any budgetary or cost that the Port relies on. Thank you for your taking the time to complete this survey. Please forward your responses to [pagprocurement@portofguam.com](mailto:pagprocurement@portofguam.com), [algsablan@portofguam.com](mailto:algsablan@portofguam.com), [macabrera@portofguam.com](mailto:macabrera@portofguam.com), [jppangelinan@portofguam.com](mailto:jppangelinan@portofguam.com), [egpangelinan@portofguam.com](mailto:egpangelinan@portofguam.com). *Non-disclosure Agreement: The purpose of this market research survey is to gauge the current market for the above services request, and to establish a budgetary amount. All information provided to the Port of Guam shall be kept strictly confidential and will not be shared, used, or distributed without written consent. The Port Authority of Guam will only use the information for the procurement planning and acquisition of the above request services. Taking this survey is completely optional and you have every right to refuse completing it. However, the information you provide will assist the Port Authority of Guam prepare the most effective method of procuring these services. The Port Authority of Guam promotes a fair and transparent procurement process and encourages all to participate.*

Zimbra

jppangelinan@portofguam.com

---

**Boom Lift Market Survey**

---

**From :** Joaquin P. Pangelinan  
<jppangelinan@portofguam.com>

Tue, Sep 19, 2023 09:25 AM

 1 attachment

**Subject :** Boom Lift Market Survey

**To :** Dave Benavente <dave.benavente@lmsfm.com>

**Cc :** Evelyn G. Pangelinan  
<egpangelinan@portofguam.com>

Good Morning Dave,

Attached is a Market Survey for a 180' Boom Lift, please complete and return as soon as possible.

Respectfully  
Joaquin P. Pangelinan  
Manager Equipment Support Services  
Maintenance Department  
Port Authority of Guam  
1026 Cabras Highway, Ste. 201 Piti, GU 96925  
Phone (671)477-5931 ex. 223  
jppangelinan@portofguam.com

---

 **Market Survey; 180 Boom Lift.docx**  
246 KB

---

Zimbra

jppangelinan@portofguam.com

---

**Re: 180 Boom Lift Market Survey**

---

**From :** Joaquin P. Pangelinan  
<jppangelinan@portofguam.com>

Tue, Sep 26, 2023 08:30 AM

**Subject :** Re: 180 Boom Lift Market Survey

**To :** Dave Benavente <dave.benavente@lmsfm.com>

Good Morning Dave,  
Following up on 180' Boom List market Survey.  
Thanks,  
Kin

---

**From:** "Joaquin Pangelinan" <jppangelinan@portofguam.com>  
**To:** "Dave Benavente" <dave.benavente@lmsfm.com>  
**Sent:** Wednesday, September 20, 2023 12:11:21 PM  
**Subject:** 180 Boom Lift Market Survey

Dave,  
sent you a Market Survey, please confirm you received it.

Respectfully  
Joaquin P. Pangelinan  
Manager Equipment Support Services  
Maintenance Department  
Port Authority of Guam  
1026 Cabras Highway, Ste. 201 Piti, GU 96925  
Phone (671)477-5931 ex. 223  
jppangelinan@portofguam.com

---



**PORT OF GUAM**  
ATURIDAT I PUETTON GUAHAN  
Jose D. Leon Guerrero Commercial Port  
1026 Cabras Highway, Suite 201, Piti, Guam 96915  
Telephone: 671-477-5931/35 Facsimile: 671-477-2689/4445  
Website: [www.portguam.com](http://www.portguam.com)



Lourdes A. Leon Guerrero  
Governor of Guam  
Joshua F. Tenorio  
Lieutenant Governor

**Market Research Survey**  
**180' Telescopic Boom Lift**  
**September 18, 2023**

COMPANY NAME: LMS Guam

Hafa Adai yan Buenas!

The Port Authority of Guam is interested in Purchasing a New Telescopic Boom Lift. We will be looking to purchase a Boom Lift with a reach of 180 feet and 750 lbs. Basket Capacity. We have a few requirements for Boom Lift. Below is a list of survey questions that we are requesting responses for. *(please refer to the non-disclosure agreement below)*

1. Is your Company an authorized service provider/dealer/ distributor for a Telescopic Boom Lift Manufacturer? Not Yet.
2. Does your company offer the above equipment and does it meet the Build American Buy American Act(BABAA).
3. Will your company be able a Build America Buy America Act Certificate from the manufacturer?
4. Does your company stock parts for said Boom Lifts?
5. What would your delivery time be for said Boom Lift?
6. If you can supply unit, what are Warranty options?
7. Does your company employ certified technicians with proprietary software to troubleshoot, diagnose, repair Boom Lifts?
8. At what price range can you offer New Boom Lift? (optional, see non-disclosure agreement below)

NAME OF INDIVIDUAL WHO COMPLETED THIS SURVEY:

Dave Benavente

We thank you for your taking the time to complete this survey. Please forward your responses to [jppangelinan@portguam.com](mailto:jppangelinan@portguam.com) or [epbagaforo@portguam.com](mailto:epbagaforo@portguam.com)

The above website is for sample purposes only and not indicative of any budgetary or cost that the Port relies on.

Thank you for your taking the time to complete this survey. Please forward your responses to [pagprocurement@portofguam.com](mailto:pagprocurement@portofguam.com), [algsablan@portofguam.com](mailto:algsablan@portofguam.com), [macabrera@portofguam.com](mailto:macabrera@portofguam.com), [jppangelinan@portofguam.com](mailto:jppangelinan@portofguam.com), [egpangelinan@portofguam.com](mailto:egpangelinan@portofguam.com). *Non-disclosure Agreement: The purpose of this market research survey is to gauge the current market for the above services request, and to establish a budgetary amount. All information provided to the Port of Guam shall be kept strictly confidential and will not be shared, used, or distributed without written consent. The Port Authority of Guam will only use the information for the procurement planning and acquisition of the above request services. Taking this survey is completely optional and you have every right to refuse completing it. However, the information you provide will assist the Port Authority of Guam prepare the most effective method of procuring these services. The Port Authority of Guam promotes a fair and transparent procurement process and encourages all to participate.*

Zimbra

jppangelinan@portofguam.com

---

**Re: Boom Lift Market Survey**

---

**From :** Joaquin P. Pangelinan  
<jppangelinan@portofguam.com>

Tue, Sep 26, 2023 08:31 AM

**Subject :** Re: Boom Lift Market Survey

**To :** Eric Aquai <eaquai@hawthornecat.com>, Jimmy Cruz  
<jpcruz@hawthornecat.com>

**Cc :** Evelyn G. Pangelinan  
<egpangelinan@portofguam.com>

Good Morning Jimmy,  
Following up on 180' Boom List market Survey.  
Thanks,  
Kin

---

**From:** "Joaquin Pangelinan" <jppangelinan@portofguam.com>  
**To:** "Eric Aquai" <eaquai@hawthornecat.com>, "Jimmy Cruz"  
<jpcruz@hawthornecat.com>  
**Cc:** "Evelyn G. Pangelinan" <egpangelinan@portofguam.com>  
**Sent:** Tuesday, September 19, 2023 9:10:34 AM  
**Subject:** Boom Lift Market Survey

Good Morning Jim,  
Attached is a Market Survey for a 180' Man Lift, please complete and return as soon as possible.

Respectfully  
Joaquin P. Pangelinan  
Manager Equipment Support Services  
Maintenance Department  
Port Authority of Guam  
1026 Cabras Highway, Ste. 201 Piti, GU 96925  
Phone (671)477-5931 ex. 223  
jppangelinan@portofguam.com

---

Zimbra

jppangelinan@portofguam.com

**FW: Guam 180ft Boom**

**From :** Eric Aquai <eaquai@hawthornecat.com>  
**Subject :** FW: Guam 180ft Boom  
**To :** Joaquin P. Pangelinan <jppangelinan@portofguam.com>

Tue, Oct 03, 2023 07:44 AM  
5 attachments

**Eric Aquai**  
Parts Supervisor

671-649-4207 | 671-487-3444

eaquai@hawthornecat.com

[www.hawthornecat.com](http://www.hawthornecat.com)

196 E. Harmon Industrial Park Road, Tamuning, Guam  
96913



**From:** Jimmy Cruz <jpcruz@hawthornecat.com>  
**Sent:** Tuesday, October 3, 2023 7:36 AM  
**To:** Eric Aquai <eaquai@hawthornecat.com>  
**Subject:** Fwd: Guam 180ft Boom

FYI.

I think that we will not be submitting a quote for this request.

Sent from my iPhone

**Jimmy Cruz**  
Account Manager

671-649-4216 | 671-488-2821





[jpcruz@hawthornecat.com](mailto:jpcruz@hawthornecat.com)

[www.hawthornecat.com](http://www.hawthornecat.com)

196 E. Harmon Industrial Park Road, Tamuning, Guam  
96913



Begin forwarded message:

**From:** "Walsh, Ryan" <[Ryan.Walsh@terex.com](mailto:Ryan.Walsh@terex.com)>  
**Date:** October 3, 2023 at 01:31:11 GMT+10  
**To:** Jimmy Cruz <[jpcruz@hawthornecat.com](mailto:jpcruz@hawthornecat.com)>  
**Subject:** **\*\*EXTERNAL\*\* Guam 180ft Boom**

**CAUTION: EXTERNAL EMAIL**

This email has originated from [Ryan.Walsh@terex.com](mailto:Ryan.Walsh@terex.com)

**DO NOT REPLY, CLICK LINKS or OPEN ATTACHMENTS** unless you recognize the sender's email address and know the content is safe..

Jimmy,

I am currently waiting on guidance for machines heading to Guam. It does not appear that our boom lift qualifies for the BABA program dues to the amount of foreign parts that are used. As soon as I hear from the team with quote guidelines, I will get you some numbers. Sorry for the continued delay

**Ryan Walsh**  
Regional Sales Manager, West

Mobile (425) 658-6462

Email [ryan.walsh@terex.com](mailto:ryan.walsh@terex.com)

Web [www.genielift.com](http://www.genielift.com)

**Genie.**  
QUALITY BY DESIGN



**PORT OF GUAM**  
ATURIDAT I PUETTON GUAHAN  
Jose D. Leon Guerrero Commercial Port  
1026 Cabras Highway, Suite 201, Piti, Guam 96915  
Telephone: 671-477-5931/35 Facsimile: 671-477-2689/4445  
Website: [www.portguam.com](http://www.portguam.com)



Lourdes A. Leon Guerrero  
Governor of Guam  
Joshua F. Tenorio  
Lieutenant Governor

**Market Research Survey**  
**180' Telescopic Boom Lift**  
**September 18, 2023**

**COMPANY NAME:** \_\_\_\_\_

Hafa Adai yan Buenas!

The Port Authority of Guam is interested in Purchasing a New Telescopic Boom Lift. We will be looking to purchase a Boom Lift with a reach of 180 feet and 750 lbs. Basket Capacity. We have a few requirements for Boom Lift. Below is a list of survey questions that we are requesting responses for. *(please refer to the non-disclosure agreement below)*

1. Is your Company an authorized service provider/dealer/ distributor for a Telescopic Boom Lift Manufacturer?
2. Does your company offer the above equipment and does it meet the Build American Buy American Act(BABAA).
3. Will your company be able a Build America Buy America Act Certificate from the manufacturer?
4. Does your company stock parts for said Boom Lifts?
5. What would your delivery time be for said Boom Lift?
6. If you can supply unit, what are Warranty options?
7. Does your company employ certified technicians with proprietary software to troubleshoot, diagnose, repair Boom Lifts?
8. At what price range can you offer New Boom Lift? (optional, see non-disclosure agreement below)

NAME OF INDIVIDUAL WHO COMPLETED THIS SURVEY: \_\_\_\_\_

We thank you for your taking the time to complete this survey. Please forward your responses to [jppangelinan@portguam.com](mailto:jppangelinan@portguam.com) or [epbagaforo@portguam.com](mailto:epbagaforo@portguam.com)

The above website is for sample purposes only and not indicative of any budgetary or cost that the Port relies on. Thank you for your taking the time to complete this survey. Please forward your responses to [pagprocurement@portofguam.com](mailto:pagprocurement@portofguam.com), [algsablan@portofguam.com](mailto:algsablan@portofguam.com), [macabrera@portofguam.com](mailto:macabrera@portofguam.com), [jppangelinan@portofguam.com](mailto:jppangelinan@portofguam.com), [egpangelinan@portofguam.com](mailto:egpangelinan@portofguam.com). *Non-disclosure Agreement: The purpose of this market research survey is to gauge the current market for the above services request, and to establish a budgetary amount. All information provided to the Port of Guam shall be kept strictly confidential and will not be shared, used, or distributed without written consent. The Port Authority of Guam will only use the information for the procurement planning and acquisition of the above request services. Taking this survey is completely optional and you have every right to refuse completing it. However, the information you provide will assist the Port Authority of Guam prepare the most effective method of procuring these services. The Port Authority of Guam promotes a fair and transparent procurement process and encourages all to participate.*

# 1850SJ

## TELESCOPIC ULTRA BOOM

BOOM LIFT

# JLG



### KEY SPECS

**Platform Height**  
185-ft 7-in / 56.56-m

**Drive Speed**  
2.8 mph / 4.5 km/h

**Horizontal Outreach**  
80-ft / 24.38-m

**Platform Capacity**  
1,000-lb / 454-kg - Restricted  
500-lb / 227-kg - Unrestricted

### KEY FEATURES

- Expansive work area of a maximum platform height of 185-ft and a telescoping jib that provides 2.9 million cubic feet of work area.
- Optimized maneuverability with full-time four-wheel drive to traverse over rough terrain.
- Enhanced Platform Controls - An LCD screen shows operators where they are in the work envelope, along with other useful information.
- Single sensor load sensing system features fewer parts and requires no weight to calibrate.

### ACCESSORIES & OPTIONS

- Accessory Packages
  - SkyWelder® Package
  - SkyPower® Package
  - SkyGlazier® Package
- Ambient White Noise Alarm
- Bolt On Fall Arrest System
- Cold Package Plus<sup>1</sup>
- Cold Weather Package<sup>2</sup>
- Hostile Environment Package<sup>1</sup>
- Light Package
- Platform Mesh, Bolt On
  - Mesh to Top Rail, Plastic or Aluminum
  - Mesh to Mid Rail, Plastic or Aluminum
- Platform Options
  - Fall Arrest, Rear Entry - 36 x 96-in
  - Drop Bar - 30 x 36-in, 36 x 96-in
  - Inward Self-Closing Swing Gate - 36 x 72-in, 36 x 96-in
  - Tri-Entry, Drop Bar - 36 x 72-in, 36 x 96-in
  - Tri-Entry, Swing Gate - 36 x 72-in, 36 x 96-in
- SkySense® Enhanced Detection System
- Soft Touch System
- Storage Tray, Center or Corner

### STANDARD SPECIFICATIONS

#### Performance

Platform Height	185-ft 7-in / 56.56-m
Horizontal Outreach	80-ft / 24.38-m
Swing	360 Degrees Continuous
Platform Capacity (Restricted)	1,000-lb / 454-kg
Platform Capacity (Unrestricted)	500-lb / 227-kg
Platform Rotator	173 Degrees Hydraulic
Jib Length (Retracted/Extended)	13-ft (3.96-m) / 20-ft (6.1-m)
Jib Range of Articulation	120 Degrees (+75, -45)
Weight *	59,900-lb / 27,170-kg
Max. Ground Bearing Pressure	119.6 psi / 8.41 kg/cm <sup>2</sup>
Drive Speed	2.8 mph / 4.5 km/h
Gradeability	40%
Tilt Cut Out	5 Degrees
Turning Radius (Inside):	
Axles Retracted/Extended	23-ft 4-in (7.12-m) / 7-ft 7-in (2.3-m)
Turning Radius (Outside):	
Axles Retracted/Extended	31-ft 3-in (9.52-m) / 21-ft 8-in (6.6-m)

#### Engine

Diesel Engine - Deutz TCD 3.6L Tier IV F	99.8 hp / 74.4 kW
Fuel Tank Capacity	45 gal / 170 L

#### Tires

Standard	445/50D710 Foam-filled
----------	------------------------

#### Hydraulic System

Capacity	75.1 gal / 284.2 L
----------	--------------------

### STANDARD FEATURES

- 12V DC Auxiliary Power
- 173 Degrees Hydraulic Platform Rotator
- 3 Selectable Steering Modes
- AC Receptacle in Platform
- All Motion Alarm
- ClearSky Smart Fleet™ Hardware (CS550)\*\*
- Control ADE® System
- Drive-Out Extendable Axles
- Engine Distress Warning/Shutdown—Selectable via JLG Analyzer
- Full-Time 4WD
- Glow Plugs
- Gull-Wing Steel Hoods
- Hourmeter
- LED Motion/Amber Beacon (CS550)\*\*
- Lifting/Tie Down Lugs
- Load Sensing System
- LCD Panel at Operator's Platform Control Console
- Platform 36 x 96-in (91 x 2.44-m) Side Entry
- Proportional Controls
- Platform Console Machine Status Light Panel\*\*\*
- Selectable Capacity Envelope
- Swing Out Engine Tray
- SkyGuard SkyLine™
- Tilt Light and Alarm

\*Certain Options or Country Standards Increase Weight

\*\*Standard Beacon and ClearSky Smart Fleet Hardware Availability Varies by Model Throughout 2011

\*\*\*Provides Indicator Lights at Platform Control Console for System Distress, Low Fuel, Degree Tilt Light and Foot Switch Status

<sup>1</sup> Includes extreme cold engine oil, fuel conditioner, engine block heater, battery blanket, glow plugs, hydraulic tank heater, and oversized footswitch

<sup>2</sup> Includes battery blanket, hydraulic tank heater, block heater

<sup>3</sup> Includes console cover, boom wipers and cylinder bellows

Additional accessories and options available via JLG Aftermarket

Shown with Optional Mesh to Top Rail

# 1850SJ

## TELESCOPIC ULTRA BOOM

BOOM LIFT



### DIMENSIONS

### REACH DIAGRAM

All dimensions are approximate

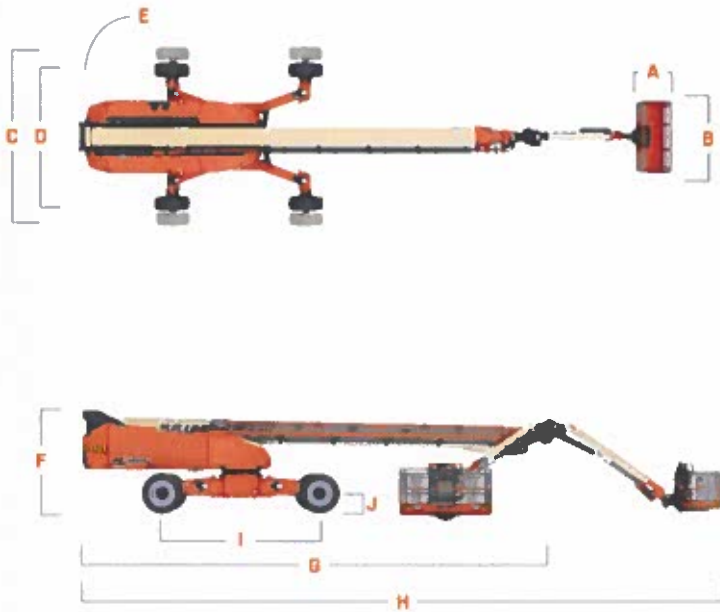

<b>A.</b> Platform Width	36 in / 91 cm
<b>B.</b> Platform Length	96 in / 2.44 m
<b>C.</b> Machine Width - Axles Extended	16-ft 6-in / 5 m
<b>D.</b> Machine Width - Axles Retracted	8-ft 2-in / 2.49 m
<b>E.</b> Tailswing	7-ft 7-in / 2.32 m
<b>F.</b> Machine Height	10-ft / 3.05 m
<b>G.</b> Machine Length - Stowed	47-ft 9.5 in / 14.57 m
<b>H.</b> Machine Length - Overall	63-ft 10-in / 19.45 m
<b>I.</b> Wheelbase	17-ft 1.5-in / 5.22 m
<b>J.</b> Ground Clearance	13.5-in / 34 cm - Axle 16.75-in / 41 cm - Chassis

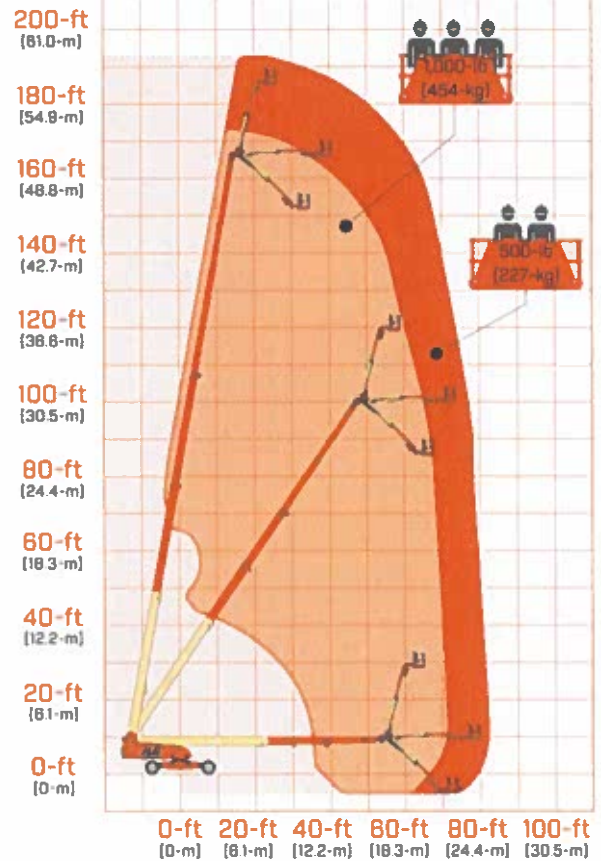

We provide coverage for one (1) full year, and cover all specified major structural components for five (5) years. Due to continuous product improvements, we reserve the right to make specification and/or equipment changes without prior notification. This machine meets or exceeds applicable ANSI and CSA requirements based on machine configuration as originally manufactured for intended applications. Please reference the serial number plate on the machine for additional information.



JLG INDUSTRIES, INC.  
Toll-free US 877-JLG-LIFT  
JLG.com

An Oshkosh Corporation Company

# 1850SJ

## TELESCOPIC ULTRA BOOM

BOOM LIFT

# JLG



### KEY SPECS

**Platform Height**  
185-ft 7-in / 56.56-m

**Drive Speed**  
2.8 mph / 4.5 km/h

**Horizontal Outreach**  
80-ft / 24.38-m

**Platform Capacity**  
1,000-lb / 454-kg - Restricted  
500-lb / 227-kg - Unrestricted

### KEY FEATURES

- Expansive work area of a maximum platform height of 185-ft and a telescoping jib that provides 2.9 million cubic feet of work area.
- Optimized maneuverability with full-time four-wheel drive to traverse over rough terrain.
- Enhanced Platform Controls - An LCD screen shows operators where they are in the work envelope, along with other useful information.
- Single sensor load sensing system features fewer parts and requires no weight to calibrate.

### ACCESSORIES & OPTIONS

- Accessory Packages
  - SkyWelder® Package
  - SkyPower® Package
  - SkyGlazier® Package
- Ambient White Noise Alarm
- Bolt On Fall Arrest System
- Cold Package Plus<sup>1</sup>
- Cold Weather Package<sup>2</sup>
- Hostile Environment Package<sup>3</sup>
- Light Package
- Platform Mesh, Bolt On
  - Mesh to Top Rail, Plastic or Aluminum
  - Mesh to Mid Rail, Plastic or Aluminum
- Platform Options
  - Fall Arrest, Rear Entry - 36 x 96-in
  - Drop Bar - 30 x 36-in, 36 x 96-in
  - Inward Self-Closing Swing Gate - 36 x 72-in, 36 x 96-in
  - Tri-Entry, Drop Bar - 36 x 72-in, 36 x 96-in
  - Tri-Entry, Swing Gate - 36 x 72-in, 36 x 96-in
- SkySense® Enhanced Detection System
- Soft Touch System
- Storage Tray, Center or Corner

### STANDARD SPECIFICATIONS

#### Performance

Platform Height	185-ft 7-in / 56.56-m
Horizontal Outreach	80-ft / 24.38-m
Swing	360 Degrees Continuous
Platform Capacity (Restricted)	1,000-lb / 454-kg
Platform Capacity (Unrestricted)	500-lb / 227-kg
Platform Rotator	173 Degrees Hydraulic
Jib Length (Retracted/Extended)	13-ft (3.96-m) / 20-ft (6.1-m)
Jib Range of Articulation	120 Degrees (+75, -45)
Weight *	59,900-lb / 27,170-kg
Max. Ground Bearing Pressure	119.6 psi / 8.41 kg/cm <sup>2</sup>
Drive Speed	2.8 mph / 4.5 km/h
Gradeability	40%
Tilt Cut Out	5 Degrees
Turning Radius (Inside)	
Axles Retracted/Extended	23-ft 4-in (7.12-m) / 7-ft 7-in (2.3-m)
Turning Radius (Outside)	
Axles Retracted/Extended	31-ft 3-in (9.52-m) / 21-ft 8-in (6.6-m)

#### Engine

Diesel Engine - Deutz TCD 3.6L Tier IV F	99.8 hp / 74.4 kW
Fuel Tank Capacity	45 gal / 170 L

#### Tires

Standard	445/50D710 Foam-filled
----------	------------------------

#### Hydraulic System

Capacity	75.1 gal / 284.2 L
----------	--------------------

### STANDARD FEATURES

- 12V-DC Auxiliary Power
- 173 Degrees Hydraulic Platform Rotator
- 3 Selectable Steering Modes
- AC Receptacle in Platform
- All Motion Alarm
- ClearSky Smart Fleet™ Hardware (CS550)\*\*
- Control ADE® System
- Drive-Out Extendable Axles
- Engine Distress Warning/Shutdown—Selectable via JLG Analyzer
- Full-Time 4WD
- Glow Plugs
- Gull-Wing Steel Hoods
- Hourmeter
- LED Motion/Amber Beacon (CS550)\*\*
- Lifting/Tie Down Lugs
- Load Sensing System
- LCD Panel at Operator's Platform Control Console
- Platform 36 x 96-in (91 x 244-cm) Side Entry
- Proportional Controls
- Platform Console Machine Status Light Panel\*\*\*
- Selectable Capacity Envelope
- Swing-Out Engine Tray
- SkyGuard SkyLine™
- Tilt Light and Alarm

\*Certain Options or Country Standards Increase Weight

\*\*Standard Beacon and ClearSky Smart Fleet Hardware Availability Varies by Model Throughout 2021

\*\*\*Provides Indicator Lights at Platform Control Console for System Distress, Low Fuel, Degree Tilt Light and Foot Switch Status

<sup>1</sup> Includes extreme cold engine oil, fuel conditioner, engine block heater, battery blanket, glow plugs, hydraulic tank heaters, and oversized footswitch

<sup>2</sup> Includes battery blanket, hydraulic tank heater, block heater

<sup>3</sup> Includes console cover, boom wipers and cylinder bellows

Additional accessories and options available via JLG Aftermarket

<sup>4</sup>Shown with Optional Mesh to Top Rail

# 1850SJ

## TELESCOPIC ULTRA BOOM

BOOM LIFT



### DIMENSIONS

All dimensions are approximate

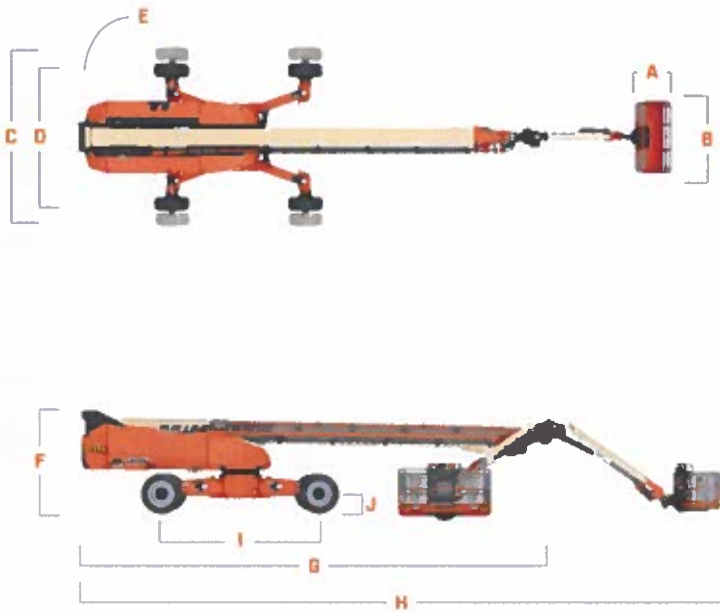

<b>A.</b> Platform Width	36 in / 91 cm
<b>B.</b> Platform Length	96 in / 2.44 m
<b>C.</b> Machine Width - Axles Extended	16-ft 6-in / 5 m
<b>D.</b> Machine Width - Axles Retracted	8 ft 2 in / 2.49 m
<b>E.</b> Tallswing	7-ft 7-in / 2.32 m
<b>F.</b> Machine Height	10-ft / 3.05 m
<b>G.</b> Machine Length - Stowed	47-ft 9.5-in / 14.57 m
<b>H.</b> Machine Length - Overall	63-ft 10-in / 19.45 m
<b>I.</b> Wheelbase	17-ft 1.5-in / 5.22 m
<b>J.</b> Ground Clearance	13.5-in / 34 cm - Axle 16.25-in / 41 cm - Chassis

### REACH DIAGRAM

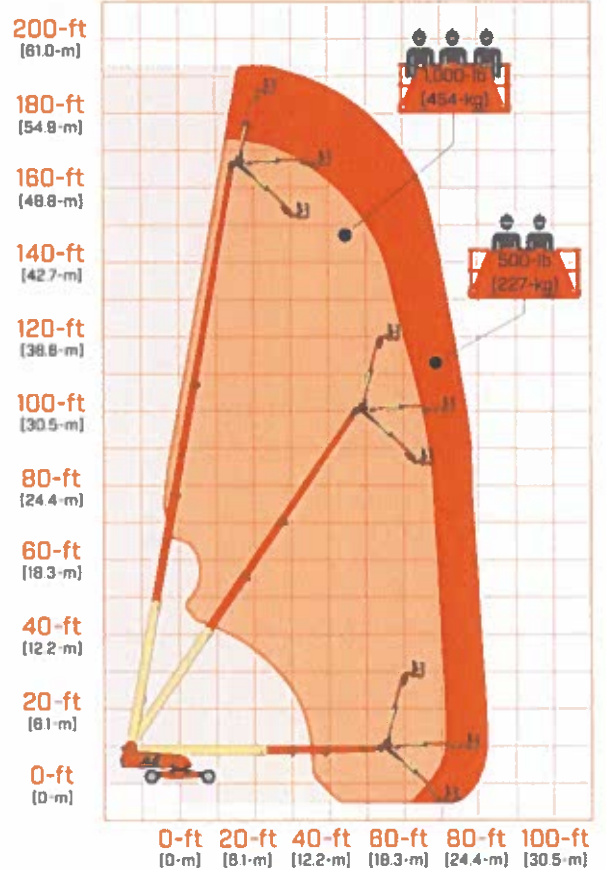

We provide coverage for one (1) full year, and cover all specified major structural components for five (5) years. Due to continuous product improvements, we reserve the right to make specification and/or equipment changes without prior notification. This machine meets or exceeds applicable ANSI and CSA requirements based on machine configuration as originally manufactured for intended applications. Please reference the serial number plate on the machine for additional information.



**JLG INDUSTRIES, INC.**  
Toll-free US 877-JLG-LIFT  
JLG.com  
An Oshkosh Corporation Company

# Certification requirements for procurement of steel, iron, construction materials, or manufactured products.

If steel, iron, construction materials, or manufactured products (as defined in § 70914(a) of the Build America, Buy America Act, Pub. L. No. 117-58, div. G, tit. IX, subtit. A, 135 Stat. 429, 1298 (2021) and Office of Management and Budget (OMB) Memorandum M-22-11, "Initial Implementation Guidance on Application of Buy America Preference in Federal Financial Assistance Programs for Infrastructure," as implemented by MARAD through Term B.5 of the exhibits to the agreement) are being procured, the same or equivalent certificate as set forth below shall be completed and submitted by each bidder or offeror in accordance with the requirement contained in section 2.1 of the agreement.

## Certificate of Compliance with Buy America Requirements

The bidder or offeror hereby certifies that it will comply with the requirements of § 70914(a) of the Build America, Buy America Act, Pub. L. No. 117-58, div. G, tit. IX, subtit. A, 135 Stat. 429, 1298 (2021), as implemented by MARAD in Term B.5 of the exhibits to the grant agreement.

Date \_\_\_\_\_

Signature \_\_\_\_\_

Company \_\_\_\_\_

Name \_\_\_\_\_

Title \_\_\_\_\_

## Certificate of Non-Compliance with Buy America Requirements

The bidder or offeror hereby certifies that it cannot comply with the requirements of § 70914(a) of the Build America, Buy America Act, Pub. L. No. 117-58, div. G, tit. IX, subtit. A, 135 Stat. 429, as implemented by MARAD in Term B.5 of the exhibits to the grant agreement, but it may qualify for an exception to the requirement pursuant to § 70914(b) of the Build America, Buy America Act and Term B.5.

Date \_\_\_\_\_

Signature \_\_\_\_\_

Company \_\_\_\_\_

Name \_\_\_\_\_

Title \_\_\_\_\_

*Need*



ITEM NO.	DESCRIPTION	QUANTITY	UNIT	UNIT PRICE	EXTENSION
1.1	Telescopic Boom Lift, 180' Reach Full time 4WD		1 EA.	\$ _____	\$ _____

**GENERALS:** These specifications have been written, to describe minimum equipment and performance requirements to be supplied by the equipment manufacture bidding. Reasonable test may be conducted upon delivery before acceptance.

The successful bidder shall furnish all necessary and desirable information and instructions for the proper operation of the equipment.

The government reserves the right to accept and/or reject any and all bids, to waive any defects, irregularities, or specification discrepancies and to award the bid as council deems to be in the best interest of the government.

**DISCREPANCIES**

**LISTED:** Should any bidder have deviations from these specifications in his bid and cannot meet every requirement of the specifications, he shall submit a letter and attach it to the bid, explaining the deviations, failure to do so will cause the bid to be rejected as being non-responsive.

**DELIVER:** The successful bidder shall deliver one (1) 180' Boom Lift each be new fully assembled and ready for operation to the Port Authority of Guam within 120 days.

**SPECIFICATIONS:**

**BIDDING AND OR REMARKS:**

**Engine:** 74 hp minimum,  
Diesel Engine  
Engine shutoff protection system  
(Low Oil Pressure, High Engine Temperature  
High Transmission Temperature)

\_\_\_\_\_

**Fuel Type:** Diesel (Ultra Low Sulfur) Tier IV

\_\_\_\_\_

**Fuel Tank:** The fuel tank furnished shall be Min. 50 gallon

-----

**Platform reach:** 180ft & 10ft jib

\_\_\_\_\_

**Platform Dimensions:**

36 x 96 with railing & side entry

-----

**Platform Capacity:**

Unrestricted - 500 lbs

\_\_\_\_\_

Restricted - 750 lbs

\_\_\_\_\_

**Platform Rotation:**

160 degrees

\_\_\_\_\_

**Special**

**Provision:** If parts catalog and maintenance repair comes in CD-ROM or Microfiche, bidder must supply to requesting agency. Bidder must still provide hard (book) copy to the requesting agency.

---

**Applicable  
Federal Laws  
And**

**Regulations:** Buy American Act – 41 U.S.C § 8301-8305  
Build America Buy America Act Certificate must be provide by the manufacture.

---

**Training:** Provide 2 sessions on pre inspection, post inspection and safe operational procedures for all operators, leaders, supervisors and dispatchers within Maintenance division.

---

**Warranty:** Manufacturers Standard Warranty, 1 year limited warranty. Service of one (1) year/ 2,000 hours, all parts, labor and oil disposal shall be included at "No Cost to the Government".

Yes, offer as requested.

---

No, Offer the following:

---

The manufacturer Warranty and Boucher shall be specified on items covered and provided in the bid packet. (Bid submission received without written warranty and Boucher as specified will be rejected).

Yes, offer as requested.

---

No, Offer the following:

---

The successful bidder shall provide technical assistance and warranty administration without any cost to "The Port Authority of Guam"

Yes, offer as requested.

---

No, Offer the following:

---

1.2 Bidding on : Telescopic Boom Lift 180' reach, Full time 4WD

MANUFACTURER: \_\_\_\_\_

MAKE: \_\_\_\_\_

MODEL: \_\_\_\_\_

YEAR: \_\_\_\_\_

PLACE OF ORIGIN: \_\_\_\_\_

DATE OF DELIVERY: \_\_\_\_\_

REVEIUED BY:



\_\_\_\_\_  
Acting Superintendent T.M.D  
Department of Public Works

DATE: 10.19.23

PORT AUTHORITY OF GUAM

REQUISITION NUMBER 21658 ON

REF: 1 EACH TELESCOPIC BOOM LIFT, 180' REACH FULL TIME 4WD

These specifications have been developed by the Port Authority of Guam Equipment Maintenance and Transportation Division.

  
\_\_\_\_\_  
RAYMOND B. SANTOS-TRANSPORTATION SUPERINTENDENT

23 OCT 23  
\_\_\_\_\_  
DATE

  
\_\_\_\_\_  
JOAQUIN P. PANGELINAN-EQUIPMENT SERVICE SUPPORT MANAGER

Oct 24, 23  
\_\_\_\_\_  
DATE

REVIEWED BY:

  
\_\_\_\_\_  
GLENN B. NELSON-OPERATIONS MANAGER

W. 24. 23  
\_\_\_\_\_  
DATE

  
\_\_\_\_\_  
DOMINIC G. MUNA-DEPUTY GENERAL MANAGER, OPERATIONS

10/24/23  
\_\_\_\_\_  
DATE

  
\_\_\_\_\_  
PACIFICO MARTIR-DEPUTY GENERAL MANAGER, FINANCE

10/25/23  
\_\_\_\_\_  
DATE

[  ] CONCURRED BY

  
\_\_\_\_\_  
RORY J. RESPICIO-GENERAL MANAGER

**PORT AUTHORITY OF GUAM  
Strategic Planning Division  
Routing Slip**

Date:  
August 4, 2023

**SUBJECT: Account Creation under MARAD's FY2022 America's Marine Highway (AMH) Program Grant No. 693JF72340007**

	Initial	Date
1. Joe G. Javellana III, Chief Planner	<i>[Signature]</i>	8/4/23
2. Pacifico R. Martir, DGMA	<i>[Signature]</i>	8/4/23
3. Jose B. Guevara III, Financial Affairs Controller	<i>[Signature]</i>	8/4/23
4. Rory J. Respicio, General Manager		
5.		
6.		
7.		
8.		

Action	File	Note and Return
<input checked="" type="checkbox"/> Approval	For Clearance	Per Conversation
<input type="checkbox"/> As Requested	For Correction	Prepare Reply
<input type="checkbox"/> Circulate	For Your Information	See Me
<input type="checkbox"/> Comment	Investigate	<input checked="" type="checkbox"/> Signature
<input type="checkbox"/> Coordination	Justify	

**REMARKS**

MARAD awarded \$9,332,831.00 for the acquisition of specialized container yard equipment; including, container handlers, forklifts, a boom lift, container yard tractors, and mobile reefer generators as part of the Guam Marine Transportation Enhancement Initiative.

The federal share of the project is \$5,703,560.00 (61%) and the PAG share is \$3,629,271.00 (39%).

<b>FROM:</b> Christopher Aguon	1026 CABRAS ISLAND HIGHWAY,
	SUITE 201 PITI GUAM 96925
	Phone No. ext. 295
	Email: <a href="mailto:cjaguon@portofguam.com">cjaguon@portofguam.com</a>

**PORT AUTHORITY OF GUAM**  
**ATURIDAT I PUETTON GUAHAN**  
 Jose D. Leon Guerrero Commercial Port  
 1026 Cabras Highway, Suite 201, Piti, Guam 96925  
 Telephone: (671) 477-5931/35 \* Facsimile: (671) 477-2689/4445  
 Website: [www.portguam.com](http://www.portguam.com)

August 4, 2023

**INTER-OFFICE MEMORANDUM**

TO: General Manager  
 Financial Affairs Controller

VIA: Deputy General Manager, Administration and Finance *pm*

FROM: Chief Planner *[Signature]*

SUBJECT: Amendment - Account Creation under MARAD's FY2022 America's Marine Highway (AMH) Program  
 Grant No. 693JF72340007

*Hafa Adai!* The Port has been awarded the FY2022 Maritime Administration (MARAD) AMH Program for the project identified below. As an update to the draft grant agreement, MARAD amended the cost for equipment, as well as the PAG share and Total Cost for the project (see table below).

Project Title	PAG Cost-Match (39%)	Federal Share (61%)	Total Cost
Guam Marine Transportation Enhancement Initiative: Acquisition of Specialized Container Yard Equipment	\$3,629,271.00	\$5,703,560.00	\$9,332,831.00

In an effort to facilitate the grant process, I recommend to amend the account. The final grant agreement is provided to you for your file and dissemination. Should you have any questions or require additional information, please feel free to contact Joe Javellana or Christopher Aguon at extension 295.

APPROVED     DISAPPROVED     CONCUR     NONCONCUR

*[Signature]*  
 \_\_\_\_\_  
 RORY J. RESPICIO, General Manager

*[Signature]*  
 \_\_\_\_\_  
 JOSE B. GUEVARA, Financial Affairs Controller

Account #: C23F003.1782.1

Enclosures:

- June 16, 2023 Inter Office Memorandum – Account Creation under MARAD's FY2022 America's Marine Highway (AMH) Program Grant No. 693JF72340007
- August 4, 2023 PAG-Signed Grant Agreement Under the Fiscal Year 2022 America's Marine Highway Program

**PORT AUTHORITY OF GUAM**  
**ATURIDAT I PUETTON GUAHAN**  
 Jose D. Leon Guerrero Commercial Port  
 1026 Cabras Highway, Suite 201, Piti, Guam 96925  
 Telephone: (671) 477-5931-35 \* Facsimile: (671) 477-2689-1445  
 Website: [www.pau.guam.gov](http://www.pau.guam.gov)

June 16, 2023

**INTER-OFFICE MEMORANDUM**

**TO:** General Manager  
 Acting Financial Affairs Controller *JP*

**VIA:** Deputy General Manager, Operations *DM*

**FROM:** Person-in-Charge *JP*

**SUBJECT:** Account Creation under MARAD's FY2022 America's Marine Highway (AMH) Program  
 Grant No. 693JF72340007

*Hafa Adai!* The Port has been awarded the FY2022 Maritime Administration (MARAD) AMH Program for the project identified below. As MARAD finalizes the grant agreement, an establishment of account is needed for this award.

Project Title	PAG Cost-Match (22%)	Federal Share (78%)	Total Cost
Guam Marine Transportation Enhancement Initiative: Acquisition of Specialized Container Yard Equipment	\$1,609,140.00	\$5,703,560.00	\$7,312,700.00

In an effort to facilitate the grant process, I recommend the creation of the account. The draft grant agreement is provided to you for your file and dissemination. Should you have any questions or require additional information, please feel free to contact Joe Javellana or Christopher Aguon at extension 295.

APPROVED     DISAPPROVED     CONCUR     NONCONCUR

*Rory J. Respicio*  
 RORY J. RESPICIO, General Manager

*Mary Jane D. Camacho 6/16/2023*  
 MARY J.G. CAMACHO, Acting Financial Affairs Controller

Account #: C28F003.1782.1 *JP 6/16/23*

*Note: This amount needed by the Port is clearly understated and will be short, unless we have the authority to reduce the quantities of the yard equipment covered in this grant. This needs more work.*  
*Rory J. Respicio*

CC: Budget

**U.S. DEPARTMENT OF TRANSPORTATION  
MARITIME ADMINISTRATION**

**GRANT AGREEMENT UNDER THE  
FISCAL YEAR 2022 AMERICA'S MARINE HIGHWAY (AMH) PROGRAM**

MARAD FY 2022 AMH Grant No. 693JF72340007

70X1750S22 2023 1GM2340007 0000150000 41010 61006600 — \$2,122,385  
702232AMHG 2023 1GM2340007 0000150000 41010 61006600 — \$3,581,175

This agreement is between the United States Department of Transportation Maritime Administration ("MARAD") and the Port Authority of Guam (the "Recipient").

This agreement reflects the selection of the Recipient to receive an AMH Grant for the Guam Marine Transportation Enhancement Initiative.

The parties therefore agree to the following:

**ARTICLE 1  
GENERAL TERMS AND CONDITIONS**

**1.1 General Terms and Conditions.**

- (a) In this agreement, "General Terms and Conditions" means the content of the document titled "General Terms and Conditions Under the Fiscal Year 2022 America's Marine Highway Program Grants," dated December 2, 2022, which is available at <https://www.maritime.dot.gov/grants-finances/federal-grant-assistance/amh-2022-general-terms-and-conditions>. The General Terms and Conditions reference the information contained in the schedules to this agreement. The General Terms and Conditions are part of this agreement.
- (b) The Recipient states that it has knowledge of the General Terms and Conditions.
- (c) The Recipient acknowledges that the General Terms and Conditions impose obligations on the Recipient and that the Recipient's non-compliance with the General Terms and Conditions may result in remedial action, terminating of the AMH Grant, disallowing costs incurred for the Project, requiring the Recipient to refund to MARAD the AMH Grant, and reporting the non-compliance in the Federal-government-wide integrity and performance system.



MAR-510  
W21-226  
Mailstop 3  
(202) 366-0586  
David.Bohnet@dot.gov

**6. Payment System.**

MARAD Payment System: Delphi eInvoicing System

**7. Office for Subaward and Contract Authorization.**

MARAD Office for Subaward and Contract Authorization: None

**8. Federal Award Identification Number.**

Federal Award Identification Number: 693JF72340007

**SCHEDULE B  
PROJECT ACTIVITIES**

**1. General Project Description.**

The Project will expand the Port's fleet of specialized container yard equipment. The equipment to be purchased includes two 40-ton loaded container handlers; three 10-ton empty container handlers; five 5.5-ton forklifts; one 180-foot boom lift; nine container yard tractor trailers; and two 40-plug mobile reefer generators.

**2. Statement of Work.**

The Project is for the purchase of equipment with the following specifications (or of similar specifications based on market availability):

**Two 40-Ton Loaded Container Handlers:**

Lift Capacity – 80,000 lbs.

Stacking Height – Must be able to stack 4-high of 9'6" ISO Container

Engine – Diesel Tier III or better

Spread – Open from 20'/40'/45'

**Three 10-Ton Empty Container Handlers:**

Lift Capacity – 15,000 lbs.

Stacking Height – Must be able to stack 4-high of 9'6" ISO Container

Engine – Diesel Tier III or better

Spreader – Single lift with vertical twist lock/open from 20'/40'/45'

**Five 5.5-Ton Forklifts:**

Lift Capacity – 11,000 lbs.

Height Lowered – Must be able to enter a standard 8'6" ISO Container

Engine – Diesel Tier III or better

Fork Adjustment – Side Shift individual and dual

**One 180-Ft. Boom Lift:**

Platform Height – 180 ft.

Platform Capacity (Restricted) – 1,000 lbs.

Platform Capacity (Unrestricted) – 500 lbs.

**Nine Container Yard Tractor Trailers:**

Engine – Diesel Tier IV

Rear Axle: 42,000 lbs. minimum

Front Axle: 12,000 lbs. minimum

Fifth Wheel: 80,000 lbs. minimum

Lifting Cylinders: Hydraulic, 63,000 lbs. minimum

**Two 40-Plug Mobile Reefer Generators:**

Receptacle Plug Model – 40-plug

**3. Documents Describing Mitigation Activities.**

None.

Purchase of Three 10-Ton Empty Container Handlers End Date:	May 1, 2026
Purchase of Five 5.5-Ton Forklifts End Date:	May 1, 2026
Purchase of One 180-Ft. Boom Lift End Date:	May 1, 2026
Purchase of Nine Container Yard Tractor Trailers End Date:	May 1, 2026
Purchase of Two 40-Plug Mobile Reefer Generators End Date:	May 1, 2026
Planned Project Substantial Completion Date:	May 1, 2026

**3. Special Milestone Deadlines.**

<b>Milestone</b>	<b>Schedule Date</b>
PAG issues Purchase Order for Two 40-Ton Loaded Container Handlers:	October 31, 2024
PAG issues Purchase Order for Three 10-Ton Empty Container Handlers:	October 31, 2024
PAG issues Purchase Order for Five 5.5-Ton Forklifts:	October 31, 2024
PAG issues Purchase Order for One 180-Ft. Boom Lift:	October 31, 2024
PAG issues Purchase Order for Nine Container Yard Tractor Trailers:	October 31, 2024
PAG issues Purchase Order for Two 40-Plug Mobile Reefer Generators:	October 31, 2024

**4. Cost Classification Table.**

<b>Cost Classification</b>	<b>Total Costs</b>	<b>Non-AMH Previously Incurred Costs</b>	<b>Eligible Costs</b>
Administrative and legal expenses	\$47,000		\$47,000
Equipment	\$9,285,831		\$9,285,831
<b>Project Total</b>	<b>\$9,332,831</b>		<b>\$9,332,831</b>

**5. Approved Pre-award Costs**

**None.** MARAD has not approved under this award any pre-award costs under 2 C.F.R. 200.458. Because unapproved costs incurred before the date of this agreement are not allowable costs under this award, MARAD will neither reimburse those costs under this award nor consider them as a non-Federal cost sharing contribution to this award. Costs incurred before the date of this agreement are allowable costs under this award only if approved in writing by MARAD before being included in the Project costs and documented in this section 5. See section 13.3(b) of the General Terms and Conditions.

**SCHEDULE F  
AMH PROGRAM DESIGNATIONS**

**1. Urban or Rural Designation.**

Urban-Rural Designation: Rural

**2. Capital or Planning Designation.**

Capital-Planning Designation: Capital

**3. Historically Disadvantaged Community Designation.**

HDC Designation: Yes

**4. Funding Act.**

IIJA	\$3,581,175
FY2022	\$2,122,385

**RECIPIENT SIGNATURE PAGE**

The Recipient, intending to be legally bound, is signing this agreement on the date stated opposite that party's signature.

**PORT AUTHORITY OF GUAM**

August 4, 2023 By:   
Date Signature of Recipient's Authorized Representative

Rory J. Respicio  
Name

General Manager  
Title



**PORT OF GUAM**  
ATURIDAT I PUETTON GUAHAN  
Jose D. Leon Guerrero Commercial Port  
1026 Cabras Highway, Suite 201, Piti, Guam 96915  
Telephone: 671-477-5931/35 Facsimile: 671-477-2689/4445  
Website: [www.portguam.com](http://www.portguam.com)



Lourdes A. Leon Guerrero  
Governor of Guam  
Joshua F. Tenorio  
Lieutenant Governor

## **TRANSMITTAL**

November 28, 2023

**TO:** Honorable Douglas B. Moylan  
Attorney General of Guam  
Attn: Civil Division

**FROM:** Rory J. Respicio  
General Manager

**SUBJECT:** Notification of Procurement over \$500,000 and Notification of Solicitation for Project No.:  
IFB/PAG-004-24 Acquisition of 180' Telescopic Boom Lift

---

*Transmitted herewith is the following:*

- Notification of Procurement (Original document)
- AG Form 014 (Original document)
- Notification of Solicitation (Original document)

**PAG COPY**

**Acknowledgement Receipt:**

Name:	Louis Mad
Date:	11/28/2023
Time:	2:03 PM







1b



**PORT OF GUAM**  
 ATURIDAT I PUETTON GUAHAN  
 Jose D. Leon Guerrero Commercial Port  
 1026 Cabras Highway, Suite 201, Piti, Guam 96915  
 Telephone: 671-477-5931/35 Facsimile: 671-477-2689/4445  
 Website: www.portguam.com



Lourdes A. Leon Guerrero  
 Governor of Guam  
 Joshua F. Tenorio  
 Lieutenant Governor

**RECEIVED**  
 General Manager's Office  
 Port Authority of Guam  
 Port Of Guam  
 Jose D. Leon Guerrero Commercial Port

OCT 25 2023  
 Received  
 Procurement and Supply Division  
 12:09pm

October 24, 2023

**INTER-OFFICE MEMORANDUM**

**TO:** General Manager  
**Via:** Procurement & Supply Manager  
**From:** Program Coordinator II  
**Subject:** **180' Telescopic Boom Lift**

*for ALG Subb Amunio*

Transmitted for your review are the following documents for the procurement of a telescopic boom lift:

1. Requisition #21658 ON
2. Determination of Need
3. Transmittal of Planning Procurement Record to PAG Procurement
4. AG Form 014 – Declaration Re Compliance with 5 GCA § 5150
5. Market Research Survey
6. Scope of Services (signed by End-User/Division Head)
7. Scope of Services Soft Copy e-mailed to Procurement
8. Advertisement BPA PDN or Daily Post (Procurement)
9. Communication Log (Includes email copies or any other correspondence record)

Thank you in advance for your continued support in our efforts to secure the procurement of much needed E1 Technician Consultant.

Should you have any questions or need more information, please feel free to contact me.

*Si Yu'os Ma'ase*

*Jac*  
 Jacqueline Cruz

[ ] Concur:  
*Rory J. Respicio*

Rory J. Respicio



## DETERMINATION OF NEED

### 180' Boom Lift

The Port Authority of Guam operates the only commercial seaport on Territory and as the primary seaport in Micronesia, serves as a transshipment port for the entire Western Pacific Region. It operates the largest U.S. deep water seaport in the Western Pacific Region and currently handles over 2 million tons of cargo a year. The Port owns, operates and maintains various cargo handling equipment to move cargoes and to support the maintenance of other cargo handling equipment's.

The Port Authority of Guam's Maintenance Department requires a 180-foot boom lift for various types of maintenance. This is the only possible way for Facility Maintenance to repair all high mast lighting for the entire terminal yard. The lift provides maintenance to access unreachable areas on our 3 Gantry Cranes for any corrosion and welding repairs. Without the ability to conduct such repairs would reduce the life span of our already aging cranes and cause significant safety concerns.



\_\_\_\_\_  
Rory J. Resepcio, General Manager



\_\_\_\_\_  
Date

# TRANSMITTAL OF PLANNING PROCUREMENT RECORD TO GSA

**Instructions:** After ascertaining the statement's accuracy and truthfulness, the agency's (director or head of agency) must sign the Certification below to indicate that the agency has kept and will keep a complete procurement record of all documents required by law as to its planning of the procurement; and is in fact transmitting a full and complete record of the planning of the procurement to GSA in accompaniment with this transmittal form as of the date this form is signed.

**Requesting/Using Agency:** Port Authority of Guam

**Re:** Telescopic Boom Lift, 180' feet Reach Full time 4WD

## 5 GCA §5249 Record of Procurement Actions

Each procurement officer shall maintain a complete record of each procurement. The record shall include the following:

- (a) the date, time, subject matter and names of participants at any meeting including government employees that is in any way related to a particular procurement;
- (b) a log of all communications between government employees and any member of the public, potential bidder, vendor or manufacturer which is in any way related to the procurement;
- (c) sound recordings of all pre-bid conferences; negotiations arising from a request for proposals and discussions with vendors concerning small purchase procurement;
- (d) brochures and submittals of potential vendors, manufacturers or contractors, and all drafts, signed and dated by the draftsman, and other papers or materials used in the development of specifications; and
- (e) the requesting agency's determination of need.

## 5 GCA §5132. Retention of Electronic Mail Correspondences

All incoming and outgoing electronic mail (email) correspondences pertaining to matters related to the procurement of goods and services as governed by this Chapter shall be retained for a period of not less than five (5) years. Such electronic mail (email) correspondences may be used for evidentiary purposes in the appellate procedures contained in this Chapter.

## 5 GCA § 10102 (d). Definition of Public Records

Public Records includes any writing containing information relating to the conduct of public business prepared, owned, used, or retained by any state or local agency in any format, including in electronic format.

The specifications for this procurement were prepared by Joaquin P. Pangelinan in keeping with the above and all applicable Guam Procurement Laws and Regulations; and, he/she/they have included all records, meeting notes and any other materials in their/its possession in developing the specifications/statement of work/scope of services/technical specification as well as any of the above procurement records items. Additionally included is the written determination of need of the need the agency for this procurement (signed by director or head of the agency) and if applicable the board or commission minutes of the approval of this procurement. Please include research as to the availability of services, market availability. In the event this procurement is funded in whole or in part with federal funds a copy of the notice of grant award and any required federal terms and conditions or forms.

**CERTIFICATION:** I hereby certify under penalty of perjury that I am responsible for the planning procurement record and I have caused to be prepared and now transmit a full and complete record of the planning procurement records as required by law. I have obtained the signed verification of all individuals involved as the preparation of the specification that this is a true and accurate statement, and that this transmittal to GSA is complete. I acknowledge that there are continuing responsibilities within the requesting/using agency as to public records related to this procurement and will make sure they are maintained as required above.

Signature: 

Print Name: Joaquin P. Pangelinan

Date: Oct 24, 23

**DECLARATION RE COMPLIANCE WITH 5 GCA § 5150**

I, RORY J. RESPICIO, make this declaration on 10/23/2023  
*[print name clearly]* *[enter today's date]*  
regarding Procurement No. REQ#: 21658-ON, and do hereby **certify under penalty of perjury** that:  
*[enter procurement no.]*

(1) I am the procurement officer (Chief Procurement Officer, Director of Public Works, or head of a purchasing agency) for this procurement;

(2) I have caused an estimate to be made of the cost of the services or supplies being procured, and for which a contract will be entered into or a purchase order will be issued, whichever is appropriate as the case may be;

(3) My estimate of the total cost of the contract or purchase order, whichever is appropriate as the case may be, is *[please check one]*:

less than \$500,000; or

\$500,000 or more;

(4) If the total estimated cost of the procurement is \$500,000 or more, I understand that I must be advised by legal counsel designated by the Attorney General (which may be an Assistant Attorney General or other legal counsel designated as Special Assistant Attorney General ("SAAG") under 5 GCA § 5150) during each and every phase of the procurement process, beginning with the planning stage and before any request for proposal or invitation to bid is issued or notice published, or before any sole source procurement or emergency procurement is undertaken;

(5) If the total estimated cost of the procurement is \$500,000 or more, I understand I may not proceed with any phase of the procurement unless I have been advised by an Assistant Attorney General or a SAAG to proceed;

(6) If the total estimated cost of the procurement is less than \$500,000 initially when the procurement is begun, but the total cost increases to \$500,000 or more at some later point in time, I understand I must contact the Attorney General's Office as soon as I become aware that the procurement will actually cost \$500,000 or more, and that I may not proceed further without the assistance of the Attorney General's Office or a SAAG; and

(7) I understand if I do not comply with the requirements of 5 GCA § 5150 and the Attorney General's Office or a SAAG has not acted as legal counsel during all phases of a procurement estimated to cost \$500,000 or more, the Attorney General or SAAG may disapprove the contract, or the procurement may be subject to cancellation, or any award, contract or purchase order made or entered into may be subject to termination.



RORY J. RESPICIO

*[Declarant's Signature]*

## **180' Boom Lift Activity log**

September 18, 23 – Sent Mark Market Survey for approval

- Sent Ray Bamba email checking if GSA had any 180' Boom Lift available

September 19, 23 – Sent out Market Survey to

- Hawthorne
- Morrico
- Far east
- LMS

September 26, - follow up calls to

- Morrico
- Hawthorne
- LMS

October 2, followed up calls to

- Hawthorne
- Received Morrico Market Survey

October 3, 23

- received response from Hawthorne
- received Morrico BABAA document

October 5, 23 – received Morico Estimated cost

October 12, 23 – received LMS market Survey

October 20, 23 – received Signed Specifications from DPW



**Zimbra****jppangelinan@portofguam.com**

---

**180' Boom Lift Survey**

---

**From :** Joaquin P. Pangelinan  
<jppangelinan@portofguam.com>

Mon, Sep 18, 2023 02:44 PM

**Subject :** 180' Boom Lift Survey

**To :** Raymond Bamba <raymond.bamba@gsa.guam.gov>

**Cc :** Evelyn G. Pangelinan  
<egpangelinan@portofguam.com>

Good Afternoon Ray,  
Researching/Sourcing for a New 180' Boom Lift, does GSA have such equipment in stock?

Respectfully  
Joaquin P. Pangelinan  
Manager Equipment Support Services  
Maintenance Department  
Port Authority of Guam  
1026 Cabras Highway, Ste. 201 Piti, GU 96925  
Phone (671)477-5931 ex. 223  
jppangelinan@portofguam.com

---

Zimbra

jppangelinan@portofguam.com

---

**Re: Boom Lift Market Survey**

---

**From :** Patrick Chargualaf <Patrick@morricoequipment.com> Thu, Oct 05, 2023 08:05 AM  
**Subject :** Re: Boom Lift Market Survey   
**To :** Joaquin P. Pangelinan  6 attachments  
<jppangelinan@portofguam.com>  
**Cc :** Ross Morrison <Ross@morricoequipment.com>, Jesse Munoz <Jesse.Munoz@morricoequipment.com>

On Market Survey, page 8, cost \$ 640,500.00

Regards,

Patrick Mafnas Chargualaf  
Generator and Equipment Sales  
Morrico Equipment

+1 (671) 649-1946 Office  
+1 (671) 649-1947 Fax  
+1 (671) 688-0309 Cell



<http://www.morricoequipment.com>

**IMPORTANT:** The sender intends that this electronic message is for exclusive use by the person to whom it is addressed. This message may contain information that is confidential or privileged and exempt from disclosure under applicable law. If the reader of this message is not an intended recipient, be aware that any disclosure, dissemination, distribution or copying of this communication, or the use of its contents, is prohibited. If you have received this message in error, please immediately notify the sender of your inadvertent receipt and delete this message from all data storage systems. Thank you

---

**From:** Joaquin P. Pangelinan <jppangelinan@portofguam.com>  
**Sent:** Thursday, October 5, 2023 8:03 AM  
**To:** Patrick Chargualaf <Patrick@morricoequipment.com>  
**Cc:** Ross Morrison <Ross@morricoequipment.com>; Jesse Munoz <Jesse.Munoz@morricoequipment.com>  
**Subject:** Re: Boom Lift Market Survey

Good Morning Pat,  
Thanks for the document, any idea of cost?  
Kin

---

**From:** "patrick" <Patrick@morricequipment.com>  
**To:** "Joaquin Pangelinan" <jppangelinan@portofguam.com>  
**Cc:** "Ross Morrison" <Ross@morricequipment.com>, "Jesse Munoz" <Jesse.Munoz@morricequipment.com>  
**Sent:** Wednesday, October 4, 2023 5:06:28 PM  
**Subject:** Re: Boom Lift Market Survey

Kin,

Good evening.

Attached sample COO From JLG for review.

Please advise if sufficient for BAA certification.

Regards,

Patrick Mafnas Chargualaf  
Generator and Equipment Sales  
Morrice Equipment

+1 (671) 649-1946 Office  
+1 (671) 649-1947 Fax  
+1 (671) 688-0309 Cell



<http://www.morricequipment.com>

**IMPORTANT:** The sender intends that this electronic message is for exclusive use by the person to whom it is addressed. This message may contain information that is confidential or privileged and exempt from disclosure under applicable law. If the reader of this message is not an intended recipient, be aware that any disclosure, dissemination, distribution or copying of this communication, or the use of its contents, is prohibited. If you have received this message in error, please immediately notify the sender of your inadvertent receipt and delete this message from all data storage systems. Thank you

---

**From:** Patrick Chargualaf <Patrick@morricoequipment.com>  
**Sent:** Monday, October 2, 2023 5:57 PM  
**To:** Joaquin P. Pangelinan <jppangelinan@portofguam.com>  
**Cc:** Ross Morrison <Ross@morricoequipment.com>; Jesse Munoz <Jesse.Munoz@morricoequipment.com>  
**Subject:** Re: Boom Lift Market Survey

Kin,

Hafa Adai and good evening.

Apologies this is late.

Please see attached and kindly reply with any questions or concerns.

Regards,

Patrick Mafnas Chargualaf  
Generator and Equipment Sales  
Morrico Equipment

+1 (671) 649-1946 Office  
+1 (671) 649-1947 Fax  
+1 (671) 688-0309 Cell



<http://www.morricoequipment.com>

**IMPORTANT:** The sender intends that this electronic message is for exclusive use by the person to whom it is addressed. This message may contain information that is confidential or privileged and exempt from disclosure under applicable law. If the reader of this message is not an intended recipient, be aware that any disclosure, dissemination, distribution or copying of this communication, or the use of its contents, is prohibited. If you have received this message in error, please immediately notify the sender of your inadvertent receipt and delete this message from all data storage systems. Thank you

---

**From:** Joaquin P. Pangelinan <jppangelinan@portofguam.com>  
**Sent:** Tuesday, September 26, 2023 9:15 AM  
**To:** Patrick Chargualaf <Patrick@morricoequipment.com>  
**Subject:** Re: Boom Lift Market Survey

thanks Pat

---

**From:** "patrick" <Patrick@morricequipment.com>  
**To:** "Joaquin Pangelinan" <jppangelinan@portofguam.com>  
**Sent:** Tuesday, September 26, 2023 8:29:41 AM  
**Subject:** Re: Boom Lift Market Survey

Kin,

Have budget number and lead time and sending latest tomorrow.

Regards,

Patrick Mafnas Chargualaf  
Generator and Equipment Sales  
Morrice Equipment

+1 (671) 649-1946 Office  
+1 (671) 649-1947 Fax  
+1 (671) 688-0309 Cell



<http://www.morriceequipment.com>

**IMPORTANT:** The sender intends that this electronic message is for exclusive use by the person to whom it is addressed. This message may contain information that is confidential or privileged and exempt from disclosure under applicable law. If the reader of this message is not an intended recipient, be aware that any disclosure, dissemination, distribution or copying of this communication, or the use of its contents, is prohibited. If you have received this message in error, please immediately notify the sender of your inadvertent receipt and delete this message from all data storage systems. Thank you

---

**From:** Joaquin P. Pangelinan <jppangelinan@portofguam.com>  
**Sent:** Tuesday, September 26, 2023 8:28 AM  
**To:** Patrick Chargualaf <Patrick@morriceequipment.com>  
**Subject:** Re: Boom Lift Market Survey

Good Morning Pat,  
Following up on 180' Boom List market Survey.  
Thanks,  
Kin

---

**From:** "Joaquin Pangelinan" <jppangelinan@portofguam.com>  
**To:** "patrick" <Patrick@morricoequipment.com>  
**Sent:** Wednesday, September 20, 2023 12:26:15 PM  
**Subject:** Re: Boom Lift Market Survey

Thanks Pat

---

**From:** "patrick" <Patrick@morricoequipment.com>  
**To:** "Joaquin Pangelinan" <jppangelinan@portofguam.com>  
**Cc:** "Jesse Munoz" <Jesse.Munoz@morricoequipment.com>  
**Sent:** Wednesday, September 20, 2023 12:11:52 PM  
**Subject:** Re: Boom Lift Market Survey

Kin,

Received and thank you.

I'll revalidate previous proposal and send ASAP.

Regards,

Patrick Mafnas Chargualaf  
Generator and Equipment Sales  
Morrico Equipment

+1 (671) 649-1946 Office  
+1 (671) 649-1947 Fax  
+1 (671) 688-0309 Cell



<http://www.morricoequipment.com>

**IMPORTANT:** The sender intends that this electronic message is for exclusive use by the person to whom it is addressed. This message may contain information that is confidential or privileged and exempt from disclosure under applicable law. If the reader of this message is not an intended recipient, be aware that any disclosure, dissemination, distribution or copying of this communication, or the use of its contents, is prohibited. If you have received this message in error, please immediately notify the sender of your inadvertent receipt and delete this message from all data storage systems. Thank you

---

**From:** Joaquin P. Pangelinan <jppangelinan@portofguam.com>

**Sent:** Wednesday, September 20, 2023 12:07 PM  
**To:** Patrick Chargualaf <patrick@morricoequipment.com>  
**Subject:** Boom Lift Market Survey

Good Morning Patrick,  
Sent this to Angel(not sure he's still there), so also sending to you.

Attached is a Market Survey for a 180' Boom Lift, please complete and return as soon as possible.

Respectfully  
Joaquin P. Pangelinan  
Manager Equipment Support Services  
Maintenance Department  
Port Authority of Guam  
1026 Cabras Highway, Ste. 201 Piti, GU 96925  
Phone (671)477-5931 ex. 223  
jppangelinan@portofguam.com

---

 **Market Survey; 180 Boom Lift - Morrico Equipment submitted 2 Oct 2023.pdf**  
277 KB

---



An Oshkosh Corporation Company

## CERTIFICATE OF ORIGIN

**DATE:** 12/13/2022

**TRADE NAME** JLG Industries, Inc.      **YEAR:** xxx

**MODEL:** 1850SJ Boom Lift      **SERIAL NO:** xxxxxxxx

**To Whom It May Concern:**

**JLG hereby declares that the goods purchased from JLG Industries, Inc.,  
McConnellsburg, PA have been manufactured in the United States and are products of  
the United States of America.**

**By: Alyssa Xu**  
Sales Analyst





**PORT OF GUAM**  
ATURIDAT I PUETTON GUAHAN  
Jose D. Leon Guerrero Commercial Port  
1026 Cabras Highway, Suite 201, Piti, Guam 96915  
Telephone: 671-477-5931/35 Facsimile: 671-477-2689/4445  
Website: [www.portguam.com](http://www.portguam.com)



Lourdes A. Leon Guerrero  
Governor of Guam  
Joshua F. Tenorio  
Lieutenant Governor

**Market Research Survey**  
**180' Telescopic Boom Lift**  
**September 18, 2023**

**COMPANY NAME:**       Morrico Equipment      

Hafa Adai yan Buenas!

The Port Authority of Guam is interested in Purchasing a New Telescopic Boom Lift. We will be looking to purchase a Boom Lift with a reach of 180 feet and 750 lbs. Basket Capacity. We have a few requirements for Boom Lift. Below is a list of survey questions that we are requesting responses for. *(please refer to the non-disclosure agreement below)*

1. Is your Company an authorized service provider/dealer/ distributor for a Telescopic Boom Lift Manufacturer?
  - Yes, JLG
  
2. Does your company offer the above equipment and does it meet the Build American Buy American Act(BABAA).
  - Yes
  
3. Will your company be able a Build America Buy America Act Certificate from the manufacturer?
  - To be Confirmed
  
4. Does your company stock parts for said Boom Lifts?
  - Yes
  
5. What would your delivery time be for said Boom Lift?
  - 12 to 14 months
  
6. If you can supply unit, what are Warranty options?
  - Manufacturer's standard "1 and 5 Years"
  
7. Does your company employ certified technicians with proprietary software to troubleshoot, diagnose, repair Boom Lifts?
  - Yes

8. At what price range can you offer New Boom Lift? (optional, see non-disclosure agreement below)

- \$ 640,500.00 USD

Digitally signed by Patrick Mathias Chargualaf  
DN: cn=Patrick Mathias Chargualaf, o=Morrisco Equipment LLC,  
ou=Governor and Equipment Sales,  
email=patrick@morriscoequipment.com, serial=2023.10.07.17.56:42 +10'00'

NAME OF INDIVIDUAL WHO COMPLETED THIS SURVEY: Patrick Chargualaf, Jesse Munoz, Ross Morrison

We thank you for your taking the time to complete this survey. Please forward your responses to [jppangelinan@portguam.com](mailto:jppangelinan@portguam.com) or [epbagaforo@portguam.com](mailto:epbagaforo@portguam.com)

The above website is for sample purposes only and not indicative of any budgetary or cost that the Port relies on. Thank you for your taking the time to complete this survey. Please forward your responses to [pagprocurement@portofguam.com](mailto:pagprocurement@portofguam.com), [algsablan@portofguam.com](mailto:algsablan@portofguam.com), [macabrera@portofguam.com](mailto:macabrera@portofguam.com), [jppangelinan@portofguam.com](mailto:jppangelinan@portofguam.com), [egpangelinan@portofguam.com](mailto:egpangelinan@portofguam.com). *Non-disclosure Agreement: The purpose of this market research survey is to gauge the current market for the above services request, and to establish a budgetary amount. All information provided to the Port of Guam shall be kept strictly confidential and will not be shared, used, or distributed without written consent. The Port Authority of Guam will only use the information for the procurement planning and acquisition of the above request services. Taking this survey is completely optional and you have every right to refuse completing it. However, the information you provide will assist the Port Authority of Guam prepare the most effective method of procuring these services. The Port Authority of Guam promotes a fair and transparent procurement process and encourages all to participate.*

Zimbra

jppangelinan@portofguam.com

---

**Re: Boom Lift Market Survey**

---

**From :** Joaquin P. Pangelinan  
<jppangelinan@portofguam.com>

Tue, Sep 26, 2023 08:31 AM

**Subject :** Re: Boom Lift Market Survey

**To :** John Limtiaco <jlimtiaco@pacificunlimitedguam.com>

Good Morning John,  
Following up on 180' Boom List Market Survey.  
Thanks,  
Kin

---

**From:** "Joaquin Pangelinan" <jppangelinan@portofguam.com>  
**To:** "John Limtiaco" <jlimtiaco@pacificunlimitedguam.com>  
**Cc:** "Evelyn G. Pangelinan" <egpangelinan@portofguam.com>  
**Sent:** Tuesday, September 19, 2023 9:22:28 AM  
**Subject:** Boom Lift Market Survey

Good Morning John,

Attached is a Market Survey for a 180' Boom Lift, please complete and return as soon as possible.

Respectfully  
Joaquin P. Pangelinan  
Manager Equipment Support Services  
Maintenance Department  
Port Authority of Guam  
1026 Cabras Highway, Ste. 201 Piti, GU 96925  
Phone (671)477-5931 ex. 223  
jppangelinan@portofguam.com

---



**PORT OF GUAM**  
ATURIDAT I PUETTON GUAHAN  
Jose D. Leon Guerrero Commercial Port  
1026 Cabras Highway, Suite 201, Piti, Guam 96915  
Telephone: 671-477-5931/35 Facsimile: 671-477-2689/4445  
Website: [www.portguam.com](http://www.portguam.com)



Lourdes A. Leon Guerrero  
Governor of Guam  
Joshua F. Tenorio  
Lieutenant Governor

**Market Research Survey**  
**180' Telescopic Boom Lift**  
**September 18, 2023**

**COMPANY NAME:** \_\_\_\_\_

Hafa Adai yan Buenas!

The Port Authority of Guam is interested in Purchasing a New Telescopic Boom Lift. We will be looking to purchase a Boom Lift with a reach of 180 feet and 750 lbs. Basket Capacity. We have a few requirements for Boom Lift. Below is a list of survey questions that we are requesting responses for. *(please refer to the non-disclosure agreement below)*

1. Is your Company an authorized service provider/dealer/ distributor for a Telescopic Boom Lift Manufacturer?
2. Does your company offer the above equipment and does it meet the Build American Buy American Act(BABAA).
3. Will your company be able a Build America Buy America Act Certificate from the manufacturer?
4. Does your company stock parts for said Boom Lifts?
5. What would your delivery time be for said Boom Lift?
6. If you can supply unit, what are Warranty options?
7. Does your company employ certified technicians with proprietary software to troubleshoot, diagnose, repair Boom Lifts?
8. At what price range can you offer New Boom Lift? (optional, see non-disclosure agreement below)

NAME OF INDIVIDUAL WHO COMPLETED THIS SURVEY: \_\_\_\_\_

We thank you for your taking the time to complete this survey. Please forward your responses to [jppangelinan@portguam.com](mailto:jppangelinan@portguam.com) or [epbagaforo@portguam.com](mailto:epbagaforo@portguam.com)

The above website is for sample purposes only and not indicative of any budgetary or cost that the Port relies on.

Thank you for your taking the time to complete this survey. Please forward your responses to [pagprocurement@portofguam.com](mailto:pagprocurement@portofguam.com), [algsablan@portofguam.com](mailto:algsablan@portofguam.com), [macabrera@portofguam.com](mailto:macabrera@portofguam.com), [jppangelinan@portofguam.com](mailto:jppangelinan@portofguam.com), [egpangelinan@portofguam.com](mailto:egpangelinan@portofguam.com). *Non-disclosure Agreement: The purpose of this market research survey is to gauge the current market for the above services request, and to establish a budgetary amount. All information provided to the Port of Guam shall be kept strictly confidential and will not be shared, used, or distributed without written consent. The Port Authority of Guam will only use the information for the procurement planning and acquisition of the above request services. Taking this survey is completely optional and you have every right to refuse completing it. However, the information you provide will assist the Port Authority of Guam prepare the most effective method of procuring these services. The Port Authority of Guam promotes a fair and transparent procurement process and encourages all to participate.*

**Zimbra****jppangelinan@portofguam.com**

---

**Boom Lift Market Survey**

---

**From :** Joaquin P. Pangelinan  
<jppangelinan@portofguam.com>

Tue, Sep 19, 2023 09:25 AM

 1 attachment

**Subject :** Boom Lift Market Survey

**To :** Dave Benavente <dave.benavente@lmsfm.com>

**Cc :** Evelyn G. Pangelinan  
<egpangelinan@portofguam.com>

Good Morning Dave,

Attached is a Market Survey for a 180' Boom Lift, please complete and return as soon as possible.

Respectfully  
Joaquin P. Pangelinan  
Manager Equipment Support Services  
Maintenance Department  
Port Authority of Guam  
1026 Cabras Highway, Ste. 201 Piti, GU 96925  
Phone (671)477-5931 ex. 223  
jppangelinan@portofguam.com

---

 **Market Survey; 180 Boom Lift.docx**  
246 KB

---

Zimbra

jppangelinan@portofguam.com

---

**Re: 180 Boom Lift Market Survey**

---

**From :** Joaquin P. Pangelinan  
<jppangelinan@portofguam.com>

Tue, Sep 26, 2023 08:30 AM

**Subject :** Re: 180 Boom Lift Market Survey

**To :** Dave Benavente <dave.benavente@lmsfm.com>

Good Morning Dave,  
Following up on 180' Boom List market Survey.  
Thanks,  
Kin

---

**From:** "Joaquin Pangelinan" <jppangelinan@portofguam.com>  
**To:** "Dave Benavente" <dave.benavente@lmsfm.com>  
**Sent:** Wednesday, September 20, 2023 12:11:21 PM  
**Subject:** 180 Boom Lift Market Survey

Dave,  
sent you a Market Survey, please confirm you received it.

Respectfully  
Joaquin P. Pangelinan  
Manager Equipment Support Services  
Maintenance Department  
Port Authority of Guam  
1026 Cabras Highway, Ste. 201 Piti, GU 96925  
Phone (671)477-5931 ex. 223  
jppangelinan@portofguam.com

---



**PORT OF GUAM**  
ATURIDAT / PUETTON GUAHAN  
Jose D. Leon Guerrero Commercial Port  
1026 Cabras Highway, Suite 201, Piti, Guam 96915  
Telephone: 671-477-5931/35 Facsimile: 671-477-2689/4445  
Website: [www.portguam.com](http://www.portguam.com)



Lourdes A. Leon Guerrero  
Governor of Guam  
Joshua F. Tenorio  
Lieutenant Governor

**Market Research Survey**  
**180' Telescopic Boom Lift**  
**September 18, 2023**

COMPANY NAME: LMS Guam

Hafa Adai yan Buenas!

The Port Authority of Guam is interested in Purchasing a New Telescopic Boom Lift. We will be looking to purchase a Boom Lift with a reach of 180 feet and 750 lbs. Basket Capacity. We have a few requirements for Boom Lift. Below is a list of survey questions that we are requesting responses for. *(please refer to the non-disclosure agreement below)*

1. Is your Company an authorized service provider/dealer/ distributor for a Telescopic Boom Lift Manufacturer? *Not Yet.*
2. Does your company offer the above equipment and does it meet the Build American Buy American Act(BABAA).
3. Will your company be able a Build America Buy America Act Certificate from the manufacturer?
4. Does your company stock parts for said Boom Lifts?
5. What would your delivery time be for said Boom Lift?
6. If you can supply unit, what are Warranty options?
7. Does your company employ certified technicians with proprietary software to troubleshoot, diagnose, repair Boom Lifts?
8. At what price range can you offer New Boom Lift? *(optional, see non-disclosure agreement below)*



NAME OF INDIVIDUAL WHO COMPLETED THIS SURVEY:

Dave Benavente

We thank you for your taking the time to complete this survey. Please forward your responses to [jppangelinan@portguam.com](mailto:jppangelinan@portguam.com) or [epbagaforo@portguam.com](mailto:epbagaforo@portguam.com)

The above website is for sample purposes only and not indicative of any budgetary or cost that the Port relies on. Thank you for your taking the time to complete this survey. Please forward your responses to [pagprocurement@portofguam.com](mailto:pagprocurement@portofguam.com), [algsablan@portofguam.com](mailto:algsablan@portofguam.com), [macabrera@portofguam.com](mailto:macabrera@portofguam.com), [jppangelinan@portofguam.com](mailto:jppangelinan@portofguam.com), [egpangelinan@portofguam.com](mailto:egpangelinan@portofguam.com). *Non-disclosure Agreement: The purpose of this market research survey is to gauge the current market for the above services request, and to establish a budgetary amount. All information provided to the Port of Guam shall be kept strictly confidential and will not be shared, used, or distributed without written consent. The Port Authority of Guam will only use the information for the procurement planning and acquisition of the above request services. Taking this survey is completely optional and you have every right to refuse completing it. However, the information you provide will assist the Port Authority of Guam prepare the most effective method of procuring these services. The Port Authority of Guam promotes a fair and transparent procurement process and encourages all to participate.*

**Zimbra****jppangelinan@portofguam.com**

---

**Re: Boom Lift Market Survey**

---

**From :** Joaquin P. Pangelinan  
<jppangelinan@portofguam.com>

Tue, Sep 26, 2023 08:31 AM

**Subject :** Re: Boom Lift Market Survey

**To :** Eric Aquai <eaquai@hawthornecat.com>, Jimmy Cruz  
<jpcruz@hawthornecat.com>

**Cc :** Evelyn G. Pangelinan  
<egpangelinan@portofguam.com>

Good Morning Jimmy,  
Following up on 180' Boom List market Survey.  
Thanks,  
Kin

---

**From:** "Joaquin Pangelinan" <jppangelinan@portofguam.com>  
**To:** "Eric Aquai" <eaquai@hawthornecat.com>, "Jimmy Cruz"  
<jpcruz@hawthornecat.com>  
**Cc:** "Evelyn G. Pangelinan" <egpangelinan@portofguam.com>  
**Sent:** Tuesday, September 19, 2023 9:10:34 AM  
**Subject:** Boom Lift Market Survey

Good Morning Jim,  
Attached is a Market Survey for a 180' Man Lift, please complete and return as soon as possible.

Respectfully  
Joaquin P. Pangelinan  
Manager Equipment Support Services  
Maintenance Department  
Port Authority of Guam  
1026 Cabras Highway, Ste. 201 Piti, GU 96925  
Phone (671)477-5931 ex. 223  
jppangelinan@portofguam.com

---

Zimbra

jppangelinan@portofguam.com

---

**FW: Guam 180ft Boom**

---

**From :** Eric Aquai <eaquai@hawthornecat.com>  
**Subject :** FW: Guam 180ft Boom  
**To :** Joaquin P. Pangelinan <jppangelinan@portofguam.com>

Tue, Oct 03, 2023 07:44 AM

5 attachments

**Eric Aquai**  
Parts Supervisor

671-649-4207 | 671-487-3444

eaquai@hawthornecat.com

[www.hawthornecat.com](http://www.hawthornecat.com)196 E. Harmon Industrial Park Road, Tamuning, Guam  
96913**HAWTHORNE CAT**

---

**From:** Jimmy Cruz <jpcruz@hawthornecat.com>  
**Sent:** Tuesday, October 3, 2023 7:36 AM  
**To:** Eric Aquai <eaquai@hawthornecat.com>  
**Subject:** Fwd: Guam 180ft Boom

FYI.

I think that we will not be submitting a quote for this request.

Sent from my iPhone

**Jimmy Cruz**  
Account Manager

671-649-4216 | 671-488-2821



[jpcruz@hawthornecat.com](mailto:jpcruz@hawthornecat.com)

[www.hawthornecat.com](http://www.hawthornecat.com)

196 E. Harmon Industrial Park Road, Tamuning, Guam  
96913



Begin forwarded message:

**From:** "Walsh, Ryan" <[Ryan.Walsh@terex.com](mailto:Ryan.Walsh@terex.com)>  
**Date:** October 3, 2023 at 01:31:11 GMT+10  
**To:** Jimmy Cruz <[jpcruz@hawthornecat.com](mailto:jpcruz@hawthornecat.com)>  
**Subject:** **\*\*EXTERNAL\*\* Guam 180ft Boom**

**CAUTION: EXTERNAL EMAIL**

This email has originated from [Ryan.Walsh@terex.com](mailto:Ryan.Walsh@terex.com)

**DO NOT REPLY, CLICK LINKS or OPEN ATTACHMENTS** unless you recognize the sender's email address and know the content is safe..

Jimmy,

I am currently waiting on guidance for machines heading to Guam. It does not appear that our boom lift qualifies for the BABA program dues to the amount of foreign parts that are used. As soon as I hear from the team with quote guidelines, I will get you some numbers. Sorry for the continued delay

**Ryan Walsh**  
Regional Sales Manager, West

Mobile (425) 658-6462  
Email [ryan.walsh@terex.com](mailto:ryan.walsh@terex.com)  
Web [www.genielift.com](http://www.genielift.com)

**Genie.**  
QUALITY BY DESIGN



**PORT OF GUAM**  
ATURIDAT I PUETTON GUAHAN  
Jose D. Leon Guerrero Commercial Port  
1026 Cabras Highway, Suite 201, Piti, Guam 96915  
Telephone: 671-477-5931/35 Facsimile: 671-477-2689/4445  
Website: [www.portguam.com](http://www.portguam.com)



Lourdes A. Leon Guerrero  
Governor of Guam  
Joshua F. Tenorio  
Lieutenant Governor

**Market Research Survey**  
**180' Telescopic Boom Lift**  
**September 18, 2023**

**COMPANY NAME:** \_\_\_\_\_

Hafa Adai yan Buenas!

The Port Authority of Guam is interested in Purchasing a New Telescopic Boom Lift. We will be looking to purchase a Boom Lift with a reach of 180 feet and 750 lbs. Basket Capacity. We have a few requirements for Boom Lift. Below is a list of survey questions that we are requesting responses for. *(please refer to the non-disclosure agreement below)*

1. Is your Company an authorized service provider/dealer/ distributor for a Telescopic Boom Lift Manufacturer?
2. Does your company offer the above equipment and does it meet the Build American Buy American Act(BABAA).
3. Will your company be able a Build America Buy America Act Certificate from the manufacturer?
4. Does your company stock parts for said Boom Lifts?
5. What would your delivery time be for said Boom Lift?
6. If you can supply unit, what are Warranty options?
7. Does your company employ certified technicians with proprietary software to troubleshoot, diagnose, repair Boom Lifts?
8. At what price range can you offer New Boom Lift? (optional, see non-disclosure agreement below)

NAME OF INDIVIDUAL WHO COMPLETED THIS SURVEY: \_\_\_\_\_

We thank you for your taking the time to complete this survey. Please forward your responses to [jppangelinan@portguam.com](mailto:jppangelinan@portguam.com) or [epbagaforo@portguam.com](mailto:epbagaforo@portguam.com)

The above website is for sample purposes only and not indicative of any budgetary or cost that the Port relies on. Thank you for your taking the time to complete this survey. Please forward your responses to [pagprocurement@portofguam.com](mailto:pagprocurement@portofguam.com), [algsablan@portofguam.com](mailto:algsablan@portofguam.com), [macabrera@portofguam.com](mailto:macabrera@portofguam.com), [jppangelinan@portofguam.com](mailto:jppangelinan@portofguam.com), [egpangelinan@portofguam.com](mailto:egpangelinan@portofguam.com). *Non-disclosure Agreement: The purpose of this market research survey is to gauge the current market for the above services request, and to establish a budgetary amount. All information provided to the Port of Guam shall be kept strictly confidential and will not be shared, used, or distributed without written consent. The Port Authority of Guam will only use the information for the procurement planning and acquisition of the above request services. Taking this survey is completely optional and you have every right to refuse completing it. However, the information you provide will assist the Port Authority of Guam prepare the most effective method of procuring these services. The Port Authority of Guam promotes a fair and transparent procurement process and encourages all to participate.*

# 1850SJ

## TELESCOPIC ULTRA BOOM

BOOM LIFT

# JLG



### KEY SPECS

**Platform Height**  
185-ft 7-in / 56.56-m

**Horizontal Outreach**  
80-ft / 24.38-m

**Drive Speed**  
2.8 mph / 4.5 km/h

**Platform Capacity**  
1,000-lb / 454-kg - Restricted  
500-lb / 227-kg - Unrestricted

### KEY FEATURES

- Expansive work area of a maximum platform height of 185-ft and a telescoping jib that provides 2.9 million cubic feet of work area.
- Optimized maneuverability with full-time four-wheel drive to traverse over rough terrain.
- Enhanced Platform Controls - An LCD screen shows operators where they are in the work envelope, along with other useful information.
- Single sensor load sensing system features fewer parts and requires no weight to calibrate.

### ACCESSORIES & OPTIONS

- Accessory Packages
  - SkyWelder® Package
  - SkyPower® Package
  - SkyGlazier® Package
- Ambient White Noise Alarm
- Bolt On Fall Arrest System
- Cold Package Plus<sup>1</sup>
- Cold Weather Package<sup>2</sup>
- Hostile Environment Package<sup>1</sup>
- Light Package
- Platform Mesh, Bolt On
  - Mesh to Top Rail, Plastic or Aluminum
  - Mesh to Mid Rail, Plastic or Aluminum
- Platform Options
  - Fall Arrest, Rear Entry - 36 x 96-in
  - Drop Bar - 30 x 36-in, 36 x 96-in
  - Inward Self-Closing Swing Gate - 36 x 72-in, 36 x 96-in
  - Tri-Entry, Drop Bar - 36 x 72-in, 36 x 96-in
  - Tri-Entry, Swing Gate - 36 x 72-in, 36 x 96-in
- SkySense® Enhanced Detection System
- Soft Touch System
- Storage Tray, Center or Corner

### STANDARD SPECIFICATIONS

#### Performance

Platform Height	185-ft 7-in / 56.56-m
Horizontal Outreach	80-ft / 24.38-m
Swing	360 Degrees Continuous
Platform Capacity (Restricted)	1,000-lb / 454-kg
Platform Capacity (Unrestricted)	500-lb / 227-kg
Platform Rotator	173 Degrees Hydraulic
Jib Length (Retracted/Extended)	13-ft (3.96-m) / 20-ft (6.1-m)
Jib Range of Articulation	120 Degrees (+75, -45)
Weight*	59,900-lb / 27,170-kg
Max. Ground Bearing Pressure	119.6 psl / 8.41 kg/cm <sup>2</sup>
Drive Speed	2.8 mph / 4.5 km/h
Gradeability	40%
Tilt Cut Out	5 Degrees
Turning Radius (Inside):	
Axles Retracted/Extended	23-ft 4-in (7.12-m) / 7-ft 7-in (2.3-m)
Turning Radius (Outside):	
Axles Retracted/Extended	31-ft 3-in (9.52-m) / 21-ft 8-in (6.6-m)

#### Engine

Diesel Engine - Deutz TCD 3.6L Tier IV F	99.8 hp / 74.4 kW
Fuel Tank Capacity	45 gal / 170 L

#### Tires

Standard	445/50D710 Foam-filled
----------	------------------------

#### Hydraulic System

Capacity	75.1 gal / 284.2 L
----------	--------------------

### STANDARD FEATURES

- 12V-DC Auxiliary Power
- 173 Degrees Hydraulic Platform Rotator
- 3 Selectable Steering Modes
- AC Receptacle in Platform
- All Motion Alarm
- ClearSky Smart Fleet™ Hardware (CSS50)\*\*
- Control ADE® System
- Drive-Out Extendable Axles
- Engine Distress Warning/Shutdown—Selectable via JLG Analyzer
- Full Time 4WD
- Glow Plugs
- Gull-Wing Steel Hoods
- Hourmeter
- LED Motion/Amber Beacon (CSS50)\*\*
- Lifting/Tie Down Lugs
- Load Sensing System
- LCD Panel at Operator's Platform Control Console
- Platform 36 x 96-in (91 x 2.44-m) Side Entry
- Proportional Controls
- Platform Console Machine Status Light Panel\*\*\*
- Selectable Capacity Envelope
- Swing-Out Engine Tray
- SkyGuard SkyLine™
- Tilt Light and Alarm

\*Certain Options or Country Standards Increase Weight

\*\*Standard Beacon and ClearSky Smart Fleet Hardware Availability Varies by Model Throughout 2023

\*\*\*Provides Indicator Lights at Platform Control Console for System Distress, Low Fuel, Degree Lift Light and Next Switch Status

1 Includes extreme cold engine oil, fuel conditioner, engine block heater, battery blanket, glow plugs, hydraulic tank heater, and oversized footswitch

2 Includes battery blanket, hydraulic tank heater, block heater

3 Includes console cover, boom wipers and cylinder bellows

Additional accessories and options available via JLG Aftermarket

Shown with Optional Mesh to Top Rail

# 1850SJ

## TELESCOPIC ULTRA BOOM

BOOM LIFT



### DIMENSIONS

All dimensions are approximate

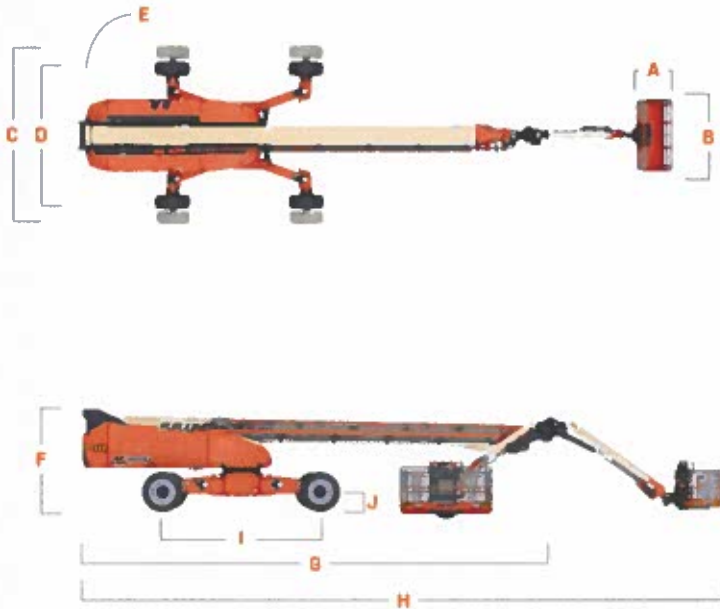

<b>A.</b> Platform Width	36-in / 91-cm
<b>B.</b> Platform Length	96-in / 2.44-m
<b>C.</b> Machine Width - Axles Extended	16-ft 6-in / 5-m
<b>D.</b> Machine Width - Axles Retracted	8-ft 2-in / 2.49-m
<b>E.</b> Tailswing	7-ft 7-in / 2.32-m
<b>F.</b> Machine Height	10-ft / 3.05-m
<b>G.</b> Machine Length - Stowed	47-ft 9.5-in / 14.57-m
<b>H.</b> Machine Length - Overall	63-ft 10-in / 19.45-m
<b>I.</b> Wheelbase	17-ft 1.5-in / 5.22-m
<b>J.</b> Ground Clearance	13.5-in / 34-cm - Axle 16.25-in / 41-cm - Chassis

### REACH DIAGRAM

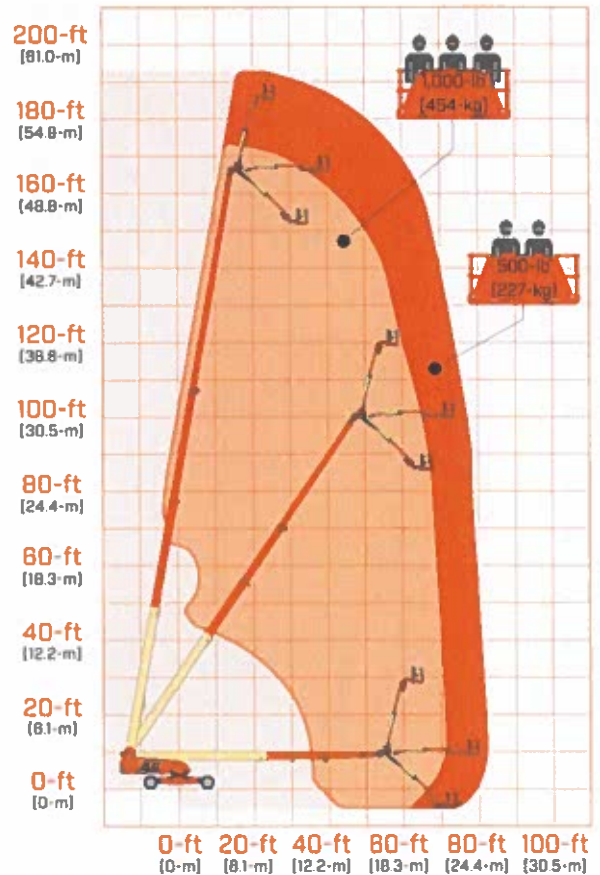

We provide coverage for one (1) full year, and cover all specified major structural components for five (5) years. Due to continuous product improvements, we reserve the right to make specification and/or equipment changes without prior notification. This machine meets or exceeds applicable ANSI and CSA requirements based on machine configuration as originally manufactured for intended applications. Please reference the serial number plate on the machine for additional information.



JLG INDUSTRIES, INC.  
Toll-free US 877-JLG-LIFT  
JLG.com

An Oshkosh Corporation Company



# 1850SJ

## TELESCOPIC ULTRA BOOM

BOOM LIFT

# JLG



### KEY SPECS

**Platform Height**  
185-ft 7-in / 56.56-m

**Drive Speed**  
2.8 mph / 4.5 km/h

**Horizontal Outreach**  
80-ft / 24.38-m

**Platform Capacity**  
1,000-lb / 454-kg - Restricted  
500-lb / 227-kg - Unrestricted

### KEY FEATURES

- Expansive work area of a maximum platform height of 185-ft and a telescoping jib that provides 2.9 million cubic feet of work area.
- Optimized maneuverability with full-time four-wheel drive to traverse over rough terrain.
- Enhanced Platform Controls - An LCD screen shows operators where they are in the work envelope, along with other useful information.
- Single sensor load sensing system features fewer parts and requires no weight to calibrate.

### ACCESSORIES & OPTIONS

- Accessory Packages
  - SkyWelder® Package
  - SkyPower® Package
  - SkyGazler® Package
- Ambient White Noise Alarm
- Bolt On Fall Arrest System
- Cold Package Plus<sup>1</sup>
- Cold Weather Package<sup>2</sup>
- Hostile Environment Package<sup>3</sup>
- Light Package
- Platform Mesh, Bolt On
  - Mesh to Top Rail, Plastic or Aluminum
  - Mesh to Mid Rail, Plastic or Aluminum
- Platform Options
  - Fall Arrest, Rear Entry - 36 x 96-in
  - Drop Bar - 30 x 36-in, 36 x 96-in
  - Inward Self Closing Swing Gate - 36 x 72-in, 36 x 96-in
  - Tri Entry, Drop Bar - 36 x 72-in, 36 x 96-in
  - Tri-Entry, Swing Gate - 36 x 72-in, 36 x 96-in
- SkySense® Enhanced Detection System
- Soft Touch System
- Storage Tray, Center or Corner

### STANDARD SPECIFICATIONS

#### Performance

Platform Height	185-ft 7-in / 56.56-m
Horizontal Outreach	80-ft / 24.38-m
Swing	360 Degrees Continuous
Platform Capacity (Restricted)	1,000-lb / 454-kg
Platform Capacity (Unrestricted)	500-lb / 227-kg
Platform Rotator	173 Degrees Hydraulic
Jib Length (Retracted/Extended)	13-ft (3.96-m) / 20-ft (6.1-m)
Jib Range of Articulation	120 Degrees (+75, -45)
Weight*	59,900-lb / 27,170-kg
Max. Ground Bearing Pressure	119.6 psl / 8.41 kg/cm <sup>2</sup>
Drive Speed	2.8 mph / 4.5 km/h
Gradeability	40%
Tilt Cut Out	5 Degrees
Turning Radius (Inside):	
Axles Retracted/Extended	23-ft 4-in (7.12-m) / 7-ft 7-in (2.3-m)
Turning Radius (Outside):	
Axles Retracted/Extended	31-ft 3-in (9.52-m) / 21-ft 8-in (6.6-m)

#### Engine

Diesel Engine - Deutz TCD 3.6L Tier IV F	99.8 hp / 74.4 kW
Fuel Tank Capacity	45 gal / 170 L

#### Tires

Standard	445/50D710 Foam-filled
----------	------------------------

#### Hydraulic System

Capacity	75.1 gal / 284.2 L
----------	--------------------

### STANDARD FEATURES

- 12V-DC Auxiliary Power
- 173 Degrees Hydraulic Platform Rotator
- 3 Selectable Steering Modes
- AC Receptacle in Platform
- All Motion Alarm
- ClearSky Smart Fleet™ Hardware (CSS50)<sup>4</sup>\*
- Control ADE® System
- Drive-Out Extendable Axles
- Engine Distress Warning/Shutdown—Selectable via JLG Analyzer
- Full-Time 4WD
- Glow Plugs
- Gull-Wing Steel Hoods
- Hourmeter
- LED Motion/Amber Beacon (CSS50)<sup>4</sup>\*
- Lifting/Tie Down Lugs
- Load Sensing System
- LCD Panel at Operator's Platform Control Console
- Platform 36 x 96-in (91 x 2.44-m) Side Entry
- Proportional Controls
- Platform Console Machine Status Light Panel<sup>4</sup>\*\*\*
- Selectable Capacity Envelope
- Swing-Out Engine Tray
- SkyGuard SkyLine™
- Tilt Light and Alarm

\*Certain Options or Country Standards Increase Weight

\*\*Standard Beacon and ClearSky Smart Fleet Hardware Availability Varies by Model Throughout 2023

\*\*\*Provides Indicator Lights at Platform Control Console for System Distress, Low Fuel, Degree Tilt Light and Foot Switch Status

1 Includes extreme cold engine oil, fuel conditioner, engine block heater, battery blanket, glow plugs, hydraulic tank heater and oversized footswitch

2 Includes battery blanket, hydraulic tank heater, block heater

3 Includes console cover, boom wipers and cylinder bellows

Additional accessories and options available via JLG Aftermarket

Shown with Optional Mesh to Top Rail

# 1850SJ

TELESCOPIC ULTRA BOOM

BOOM LIFT



## DIMENSIONS

All dimensions are approximate

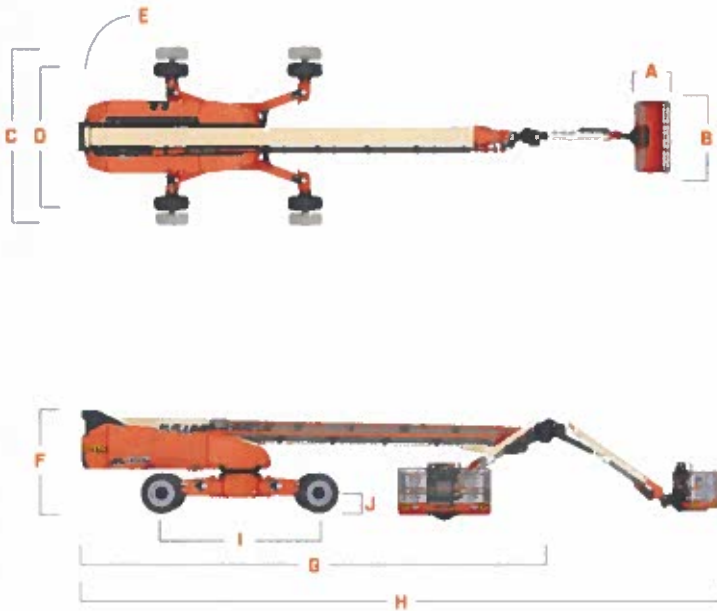

<b>A.</b> Platform Width	36 in / 91 cm
<b>B.</b> Platform Length	96 in / 2.44 m
<b>C.</b> Machine Width - Axles Extended	16 ft 6 in / 5 m
<b>D.</b> Machine Width - Axles Retracted	8 ft 2 in / 2.49 m
<b>E.</b> Tailswing	7 ft 7 in / 2.32 m
<b>F.</b> Machine Height	10 ft / 3.05 m
<b>G.</b> Machine Length - Stowed	47 ft 9.5 in / 14.57 m
<b>H.</b> Machine Length - Overall	63 ft 10 in / 19.45 m
<b>I.</b> Wheelbase	17 ft 1.5 in / 5.22 m
<b>J.</b> Ground Clearance	13.5 in / 34 cm - Axle 16.25 in / 41 cm - Chassis

## REACH DIAGRAM

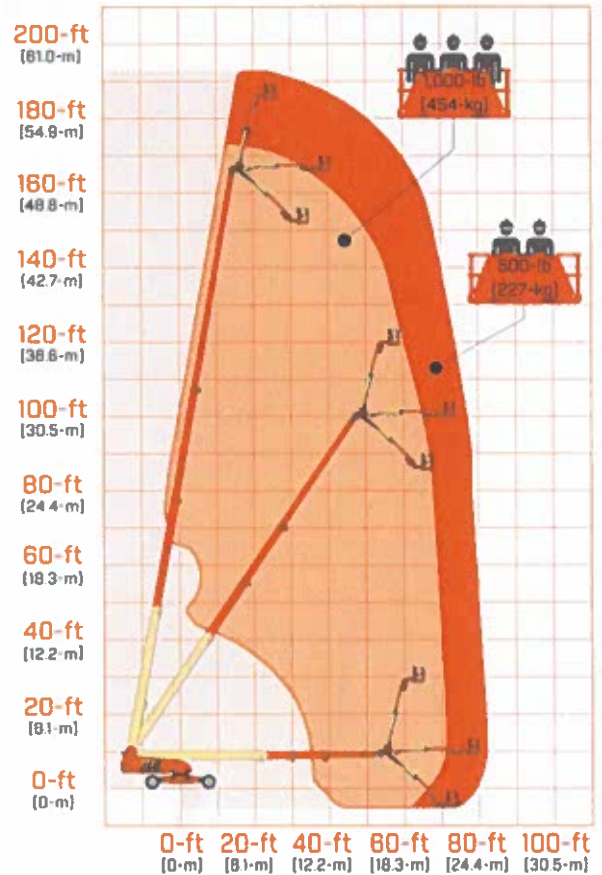

We provide coverage for one (1) full year, and cover all specified major structural components for five (5) years. Due to continuous product improvements, we reserve the right to make specification and/or equipment changes without prior notification. This machine meets or exceeds applicable ANSI and CSA requirements based on machine configuration as originally manufactured for intended applications. Please reference the serial number plate on the machine for additional information.



JLG INDUSTRIES, INC.  
Toll-free US 877-JLG-LIFT  
JLG.com

An Oshkosh Corporation Company

ITEM NO.	DESCRIPTION	QUANTITY	UNIT	UNIT PRICE	EXTENSION
1.1	Telescopic Boom Lift, 180' Reach Full time 4WD		1 EA.	\$ _____	\$ _____

**GENERALS:** These specifications have been written, to describe minimum equipment and performance requirements to be supplied by the equipment manufacture bidding. Reasonable test may be conducted upon delivery before acceptance.

The successful bidder shall furnish all necessary and desirable information and instructions for the proper operation of the equipment.

The government reserves the right to accept and/or reject any and all bids, to waive any defects, Irregularities, or specification discrepancies and to award the bid as council deems to be in the best interest of the government.

**DISCREPANCIES**

**LISTED:** Should any bidder have deviations from these specifications in his bid and cannot meet every requirement of the specifications, he shall submit a letter and attach it to the bid, explaining the deviations, failure to do so will cause the bid to be rejected as being non-responsive.

**DELIVER:** The successful bidder shall deliver one (1) 180' Boom Lift each be new fully assembled and ready for operation to the Port Authority of Guam within 120 days.

**SPECIFICATIONS:**

**BIDDING AND OR REMARKS:**

**Engine:** 74 hp minimum,  
Diesel Engine  
Engine shutoff protection system  
(Low Oil Pressure, High Engine Temperature  
High Transmission Temperature)

\_\_\_\_\_

**Fuel Type:** Diesel (Ultra Low Sulfur) Tier IV

\_\_\_\_\_

**Fuel Tank:** The fuel tank furnished shall be Min. 50 gallon

-----

**Platform reach:** 180ft & 10ft jib

\_\_\_\_\_

**Platform Dimensions:**

36 x 96 with railing & side entry

-----

**Platform Capacity:**

Unrestricted - 500 lbs

\_\_\_\_\_

Restricted - 750 lbs

\_\_\_\_\_

**Platform Rotation:**

160 degrees

\_\_\_\_\_

**Swing:** 360 degrees continuous \_\_\_\_\_

**Steering:** Selectable Steering (ground level or platform) \_\_\_\_\_

**Axles:** Extendable front and rear \_\_\_\_\_

**Gauges:** Air, Fuel, Hour, Volt, Temp, and Oil \_\_\_\_\_

**Lights:** 2 Headlights in facing forward with protective guard,  
2 Headlights facing rear with protective guard.  
2 work lights on platform \_\_\_\_\_

**Tires:** Protector Lug Foam Filled tires \_\_\_\_\_

**Manlift Accessories:**

Platform to be plumbed with air lines for use of pneumatic Tools \_\_\_\_\_

Hostile Weather/Environment Kit \_\_\_\_\_

AC plug/outlet in platform \_\_\_\_\_

**Accessories:**

Standard manufacture accessories' to include \_\_\_\_\_

Horn - Electric \_\_\_\_\_

Amber strobe light, key switch "on position" activated. \_\_\_\_\_

Mounted 5 lbs. fire extinguisher on platform \_\_\_\_\_

1 set "Shop Type" repair manuals and complete illustrated parts manual. \_\_\_\_\_

Diagnostic and Troubleshooting software \_\_\_\_\_

Owner/Operator manual for each equipment \_\_\_\_\_

Maintenance and Service manual for each equipment \_\_\_\_\_

Warranty booklet for each equipment \_\_\_\_\_

Recommended spare parts list \_\_\_\_\_

All fluids to the fullest level \_\_\_\_\_

Fuel tank to be loaded with 10 gallons of diesel. \_\_\_\_\_

Electronic Backup alarm \_\_\_\_\_

Engine shut-off protection system (Low Oil Pressure, High Engine Temperature and High Transmission Temperatures), \_\_\_\_\_

Reflective Conspicuity Tape \_\_\_\_\_

Electronic rust prevention system \_\_\_\_\_

**Receiving**

**Date:** (Acceptance Date) will be Three (3) days after delivery Date, provided the Equipment is Delivered Completely Assembled and meets all specifications, terms and conditions of the bid requirements. \_\_\_\_\_

**Special**

**Provision:** If parts catalog and maintenance repair comes in CD-ROM or Microfiche, bidder must supply to requesting agency. Bidder must still provide hard (book) copy to the requesting agency.

---

**Applicable  
Federal Laws  
And**

**Regulations:** Buy American Act – 41 U.S.C § 8301-8305  
Build America Buy America Act Certificate must be provide by the manufacture.

---

**Training:** Provide 2 sessions on pre inspection, post inspection and safe operational procedures for all operators, leaders, supervisors and dispatchers within Maintenance division.

---

**Warranty:** Manufacturers Standard Warranty, 1 year limited warranty. Service of one (1) year/ 2,000 hours, all parts, labor and oil disposal shall be included at "No Cost to the Government".

Yes, offer as requested. \_\_\_\_\_

No, Offer the following: \_\_\_\_\_

The manufacturer Warranty and Boucher shall be specified on items covered and provided in the bid packet. (Bid submission received without written warranty and Boucher as specified will be rejected).

Yes, offer as requested. \_\_\_\_\_

No, Offer the following: \_\_\_\_\_

The successful bidder shall provide technical assistance and warranty administration without any cost to "The Port Authority of Guam"

Yes, offer as requested. \_\_\_\_\_

No, Offer the following: \_\_\_\_\_

The successful bidder shall provide service, such as to determine deficiency, repair or adjustment of the equipment on government premises or transfer the equipment to the shop where the repair should be done, at anytime within the warranty period and at "No cost to the Government". When the equipment is down for warranty repair(s) and remain in shop for a certain period awaiting part(s) and or material(s), the total down-time period shall be extended to the service and warranty period.

Yes, offer as requested. \_\_\_\_\_

No, Offer the following: \_\_\_\_\_

The manufacture shall have a local authorized dealer who can provide factory trained service technician(s). Bidder shall provide certification of factory trained technician(s) for the above equipments be purchased during commissioning. Failure to provided will result as "Unacceptable".

Yes, offer as requested. \_\_\_\_\_

No, Offer the following: \_\_\_\_\_

Provide Complete Familiarization Training to Port Representatives on maintenance of Mechanical, Electrical and Hydraulic systems on units by manufacturer. All costs Associated with training (airfare, lodging and transportation) are to be included At no cost to the Government of Guam.

Yes, offer as requested. \_\_\_\_\_

No, Offer the following: \_\_\_\_\_

**Notes: Bidder shall identify on their bids, any deviations from the specifications or requirements in the remarks column and state item being offered for evaluation processing. Failure to comply may result in rejection of bid.**

**Certificate of Origin is required on sale of the vehicle.**

**Equipment must be delivered to Port Authority of Guam for inspection.**

1.2 Bidding on : Telescopic Boom Lift 180' reach, Full time 4WD

MANUFACTURER: \_\_\_\_\_

MAKE: \_\_\_\_\_

MODEL: \_\_\_\_\_

YEAR: \_\_\_\_\_

PLACE OF ORIGIN: \_\_\_\_\_

DATE OF DELIVERY: \_\_\_\_\_

REVEIUED BY:



\_\_\_\_\_  
Acting Superintendent T.M.D  
Department of Public Works

DATE: 10-19-03





PORT AUTHORITY OF GUAM

REQUISITION NUMBER 21658 ON

REF: 1 EACH TELESCOPIC BOOM LIFT, 180' REACH FULL TIME 4WD

These specifications have been developed by the Port Authority of Guam Equipment Maintenance and Transportation Division.

  
\_\_\_\_\_  
RAYMOND B. SANTOS-TRANSPORTATION SUPERINTENDENT

28 Oct 23  
\_\_\_\_\_  
DATE

  
\_\_\_\_\_  
JOAQUIN P. FANGELINAN-EQUIPMENT SERVICE SUPPORT MANAGER

Oct 24, 23  
\_\_\_\_\_  
DATE

REVIEWED BY:

  
\_\_\_\_\_  
GLENN B. NELSON-OPERATIONS MANAGER

10. 24. 23  
\_\_\_\_\_  
DATE

  
\_\_\_\_\_  
DOMINIC G. MUNA-DEPUTY GENERAL MANAGER, OPERATIONS

10/24/23  
\_\_\_\_\_  
DATE

  
\_\_\_\_\_  
PACIFICO MARTIR-DEPUTY GENERAL MANAGER, FINANCE

10/25/23  
\_\_\_\_\_  
DATE

[  ] CONCURRED BY

  
\_\_\_\_\_  
RORY J. RESPICIO-GENERAL MANAGER

**PORT AUTHORITY OF GUAM  
Strategic Planning Division  
Routing Slip**

Date:

August 4, 2023

**SUBJECT:** Account Creation under MARAD's FY2022 America's Marine Highway (AMH) Program Grant No. 693JF72340007

Initial

Date

1. Joe G. Javellana III, Chief Planner

*[Signature]*

8/4/23

2. Pacifico R. Martir, DGMA

*[Signature]*

8/4/23

3. Jose B. Guevara III, Financial Affairs Controller

*[Signature]*

8/4/23

4. Rory J. Respicio, General Manager

5.

6.

7.

8.

Action	File	Note and Return
<input checked="" type="checkbox"/> Approval	<input type="checkbox"/> For Clearance	<input type="checkbox"/> Per Conversation
<input type="checkbox"/> As Requested	<input type="checkbox"/> For Correction	<input type="checkbox"/> Prepare Reply
<input type="checkbox"/> Circulate	<input type="checkbox"/> For Your Information	<input type="checkbox"/> See Me
<input type="checkbox"/> Comment	<input type="checkbox"/> Investigate	<input checked="" type="checkbox"/> Signature
<input type="checkbox"/> Coordination	<input type="checkbox"/> Justify	<input type="checkbox"/>

**REMARKS**

MARAD awarded \$9,332,831.00 for the acquisition of specialized container yard equipment; including, container handlers, forklifts, a boom lift, container yard tractors, and mobile reefer generators as part of the Guam Marine Transportation Enhancement Initiative.

The federal share of the project is \$5,703,560.00 (61%) and the PAG share is \$3,629,271.00 (39%).

**FROM:** Christopher Aguon

1026 CABRAS ISLAND HIGHWAY,

SUITE 201 PITI GUAM 96925

Phone No. ext. 295

Email: [cjaguon@portofguam.com](mailto:cjaguon@portofguam.com)



**PORT AUTHORITY OF GUAM**

**ATURIDAT I PUETTON GUAHAN**

Jose D. Leon Guerrero Commercial Port

1026 Cabras Highway, Suite 201, Piti, Guam 96925

Telephone: (671) 477-5931/35 \* Facsimile: (671) 477-2689/4445

Website: [www.portguam.com](http://www.portguam.com)

August 4, 2023

**INTER-OFFICE MEMORANDUM**

TO: General Manager  
Financial Affairs Controller

VIA: Deputy General Manager, Administration and Finance *pm*

FROM: Chief Planner *[Signature]*

SUBJECT: Amendment - Account Creation under MARAD's FY2022 America's Marine Highway (AMH) Program  
Grant No. 693JF72340007

*Hafa Adai!* The Port has been awarded the FY2022 Maritime Administration (MARAD) AMH Program for the project identified below. As an update to the draft grant agreement, MARAD amended the cost for equipment, as well as the PAG share and Total Cost for the project (see table below).

Project Title	PAG Cost-Match (39%)	Federal Share (61%)	Total Cost
Guam Marine Transportation Enhancement Initiative: Acquisition of Specialized Container Yard Equipment	\$3,629,271.00	\$5,703,560.00	\$9,332,831.00

In an effort to facilitate the grant process, I recommend to amend the account. The final grant agreement is provided to you for your file and dissemination. Should you have any questions or require additional information, please feel free to contact Joe Javellana or Christopher Aguon at extension 295.

APPROVED     DISAPPROVED     CONCUR     NONCONCUR

*[Signature]*  
RORY J. RESPICIO, General Manager

*[Signature]*  
JOSE B. GUEVARA, Financial Affairs Controller

Account #: C23F003.1782.1

Enclosures:

June 16, 2023 Inter-Office Memorandum – Account Creation under MARAD's FY2022 America's Marine Highway (AMH) Program Grant No. 693JF72340007

August 4, 2023 PAG-Signed Grant Agreement Under the Fiscal Year 2022 America's Marine Highway Program

**PORT AUTHORITY OF GUAM**  
**ATURIDAT I PUETTON GUAHAN**  
 Jose D. Leon Guerrero Commercial Port  
 1026 Cabras Highway, Suite 201, Pita, Guam 96925  
 Telephone: (671) 477-5931/35 \* Facsimile: (671) 477-2689/1115  
 Website: [www.paguam.com](http://www.paguam.com)

June 16, 2023

**INTER-OFFICE MEMORANDUM**

**TO:** General Manager  
 Acting Financial Affairs Controller *[Signature]*

**VIA:** Deputy General Manager, Operations *[Signature]*

**FROM:** Person-in-Charge *[Signature]*

**SUBJECT:** Account Creation under MARAD's FY2022 America's Marine Highway (AMH) Program  
 Grant No. 693JF72340007

*Hafa Adai!* The Port has been awarded the FY2022 Maritime Administration (MARAD) AMH Program for the project identified below. As MARAD finalizes the grant agreement, an establishment of account is needed for this award.

Project Title	PAG Cost-Match (22%)	Federal Share (78%)	Total Cost
Guam Marine Transportation Enhancement Initiative: Acquisition of Specialized Container Yard Equipment	\$1,609,140.00	\$5,703,560.00	\$7,312,700.00

In an effort to facilitate the grant process, I recommend the creation of the account. The draft grant agreement is provided to you for your file and dissemination. Should you have any questions or require additional information, please feel free to contact Joe Javellana or Christopher Aguon at extension 295.

APPROVED     DISAPPROVED     CONCUR     NONCONCUR

*[Signature]*  
 RORY J. RESPICIO, General Manager

*[Signature]* 6/16/23  
 MARY J.G. CAMACHO, Acting Financial Affairs Controller

Account #: C23F003.1782.1 *to 6/16/23*

*Note: This amount needed by the Port is clearly understated and will be short, unless we have the authority to reduce the quantities of the yard equipment covered in this grant. This needs more work.*  
*Rory J. Respicio*

CC: Budget

*6/19/23*  
**RECEIVED**  
 General Manager's Office  
 Port Authority of Guam

<b>PORT AUTHORITY OF GUAM</b> <b>Strategic Planning Division</b> <b>Routing Slip</b>	June 16, 2023
--	---------------

<b>SUBJECT:</b> Account Creation under MARAD's FY2022 America's Marine Highway (AMH) Program Grant No. 693JF72340007	Initial	Date
1. Dora Perez, Person-In-Charge - Strategic Planning	<i>DP</i>	<i>6/16/2023</i>
2. Dominic Muna, DGMO	<i>DM</i>	<i>6/14/23</i>
3. Mary Jane Camacho, Acting Financial Affairs Controller	<i>mjc</i>	<i>6/16/23</i>
4. Rory Respicio, General Manager	<i>RR</i>	<i>6/19/23</i>
5.		
6.		
7.		
8.		

	Action	File	Note and Return
<input checked="" type="checkbox"/>	Approval	For Clearance	Per Conversation
<input type="checkbox"/>	As Requested	For Correction	Prepare Reply
<input type="checkbox"/>	Circulate	For Your Information	See Me
<input type="checkbox"/>	Comment	Investigate	Signature <input checked="" type="checkbox"/>
<input type="checkbox"/>	Coordination	Justify	

**REMARKS**

MARAD awarded \$7,312,700.00 for acquisition of specialized container yard equipment; including, container handlers, forklifts, a boom lift, container yard tractors, and mobile reefer generators as part of the Guam Marine Transportation Enhancement Initiative.

The federal share of the project is \$5,703,560.00 (78%) and the PAG share is \$1,609,140.00 (22%).

<b>FROM:</b> Christopher Aguon	1026 CABRAS ISLAND HIGHWAY,
	SUITE 201 PITI GUAM 96925
	Phone No ext. 295
	Email <a href="mailto:cjaguon@portofguam.com">cjaguon@portofguam.com</a>

**U.S. DEPARTMENT OF TRANSPORTATION  
MARITIME ADMINISTRATION**

**GRANT AGREEMENT UNDER THE  
FISCAL YEAR 2022 AMERICA'S MARINE HIGHWAY (AMH) PROGRAM**

MARAD FY 2022 AMH Grant No. 693JF72340007

70X1750S22 2023 1GM2340007 0000150000 41010 61006600 — \$2,122,385  
702232AMHG 2023 1GM2340007 0000150000 41010 61006600 — \$3,581,175

This agreement is between the United States Department of Transportation Maritime Administration (“MARAD”) and the Port Authority of Guam (the “Recipient”).

This agreement reflects the selection of the Recipient to receive an AMH Grant for the Guam Marine Transportation Enhancement Initiative.

The parties therefore agree to the following:

**ARTICLE 1  
GENERAL TERMS AND CONDITIONS**

**1.1 General Terms and Conditions.**

- (a) In this agreement, “General Terms and Conditions” means the content of the document titled “General Terms and Conditions Under the Fiscal Year 2022 America’s Marine Highway Program Grants,” dated December 2, 2022, which is available at <https://www.maritime.dot.gov/grants-finances/federal-grant-assistance/amh-2022-general-terms-and-conditions>. The General Terms and Conditions reference the information contained in the schedules to this agreement. The General Terms and Conditions are part of this agreement.
- (b) The Recipient states that it has knowledge of the General Terms and Conditions.
- (c) The Recipient acknowledges that the General Terms and Conditions impose obligations on the Recipient and that the Recipient’s non-compliance with the General Terms and Conditions may result in remedial action, terminating of the AMH Grant, disallowing costs incurred for the Project, requiring the Recipient to refund to MARAD the AMH Grant, and reporting the non-compliance in the Federal-government-wide integrity and performance system.

**ARTICLE 2**  
**SPECIAL TERMS AND CONDITIONS**

**2.1 Buy America Certifications.**

Prior to entering into contracts to procure equipment under this Project, the Recipient agrees to provide to all MARAD contacts who are listed in section 5 of schedule A and all MARAD contacts who are listed in section 2.2 of the General Terms and Conditions Buy America certifications in the format prescribed by MARAD from all bidders or offerors, attesting that each piece of equipment procured under this award meets the Buy America requirements outlined in section 12.2 of the General Terms and Conditions, available at <https://www.maritime.dot.gov/grants-finances/federal-grant-assistance/amh-2022-general-terms-and-conditions> and Exhibit B, Term B.5, available at <https://www.maritime.dot.gov/grants-finances/federal-grant-assistance/marad-fy-2022-americas-marine-highway-exhibits>. MARAD will notify the Recipient within 10 business days of receiving the certification whether the certification is sufficient, at which point the Recipient may then enter into a contract for that piece of equipment.

**SCHEDULE A  
ADMINISTRATIVE INFORMATION**

**1. Application.**

Application Title: Guam Marine Transportation Enhancement Initiative: Acquisition of Specialized Container Yard Equipment

Application Date: June 17, 2022

**2. Recipient's Unique Entity Identifier.**

Recipient's Unique Entity Identifier: QDZSBLMLN5C6

**3. Recipient Contact(s).**

Jose G. Javellana III  
Chief Planner  
Port Authority of Guam  
1026 Cabras Highway, Suite 201  
Piti, Guam 96925  
(671) 477-5931  
jgjavellana@portofguam.com

**4. Recipient Key Personnel.**

None.

**5. MARAD Project Contact(s).**

Kelly Mitchell-Carroll  
Grants and Cooperative Agreement Officer  
DOT – Maritime Administration  
1200 New Jersey Ave, SE  
Washington, DC 20590  
MAR-380  
W26-422  
Mailstop 5  
(202) 366-9714  
k.mitchell-carroll@dot.gov

and

David Bohnet  
Supervisory Grant Management Specialist  
DOT – Maritime Administration  
1200 New Jersey Ave, SE  
Washington, DC 20590



MAR-510  
W21-226  
Mailstop 3  
(202) 366-0586  
David.Bohnet@dot.gov

**6. Payment System.**

MARAD Payment System: Delphi eInvoicing System

**7. Office for Subaward and Contract Authorization.**

MARAD Office for Subaward and Contract Authorization: None

**8. Federal Award Identification Number.**

Federal Award Identification Number: 693JF72340007

**SCHEDULE B  
PROJECT ACTIVITIES**

**1. General Project Description.**

The Project will expand the Port's fleet of specialized container yard equipment. The equipment to be purchased includes two 40-ton loaded container handlers; three 10-ton empty container handlers; five 5.5-ton forklifts; one 180-foot boom lift; nine container yard tractor trailers; and two 40-plug mobile reefer generators.

**2. Statement of Work.**

The Project is for the purchase of equipment with the following specifications (or of similar specifications based on market availability):

**Two 40-Ton Loaded Container Handlers:**

Lift Capacity – 80,000 lbs.

Stacking Height – Must be able to stack 4-high of 9'6" ISO Container

Engine – Diesel Tier III or better

Spread – Open from 20'/40'/45'

**Three 10-Ton Empty Container Handlers:**

Lift Capacity – 15,000 lbs.

Stacking Height – Must be able to stack 4-high of 9'6" ISO Container

Engine – Diesel Tier III or better

Spreader – Single lift with vertical twist lock/open from 20'/40'/45'

**Five 5.5-Ton Forklifts:**

Lift Capacity – 11,000 lbs.

Height Lowered – Must be able to enter a standard 8'6" ISO Container

Engine – Diesel Tier III or better

Fork Adjustment – Side Shift individual and dual

**One 180-Ft. Boom Lift:**

Platform Height – 180 ft.

Platform Capacity (Restricted) – 1,000 lbs.

Platform Capacity (Unrestricted) – 500 lbs.

**Nine Container Yard Tractor Trailers:**

Engine – Diesel Tier IV

Rear Axle: 42,000 lbs. minimum

Front Axle: 12,000 lbs. minimum

Fifth Wheel: 80,000 lbs. minimum

Lifting Cylinders: Hydraulic, 63,000 lbs. minimum

**Two 40-Plug Mobile Reefer Generators:**

Receptacle Plug Model – 40-plug

**3. Documents Describing Mitigation Activities.**

None.

**SCHEDULE C  
AWARD DATES AND PROJECT SCHEDULE**

**1. Award Dates.**

**Budget Period End Date:** March 2, 2027  
**Period of Performance End Date:** March 2, 2030

**2. Estimated Project Schedule.**

<b>Milestone</b>	<b>Schedule Date</b>
Completion of IFB documents to include Solicitation Announcement, Submission, Evaluation, & Selection of Winning Bidder	December 31, 2023
Port Authority of Guam (PAG) Management, Board of Directors, and Public Utilities Commission (PUC) contract approvals	March 31, 2024
End of 30-day Period for PAG Procurement issuance of Purchase Order, Two 40-Ton Loaded Container Handlers:	April 30, 2024
End of 30-day Period for PAG Procurement issuance of Purchase Order, Three 10-Ton Empty Container Handlers:	April 30, 2024
End of 30-day Period for PAG Procurement issuance of Purchase Order, Five 5.5-Ton Forklifts:	April 30, 2024
End of 30-day Period for PAG Procurement issuance of Purchase Order, One 180-Ft. Boom Lift:	April 30, 2024
End of 30-day Period for PAG Procurement issuance of Purchase Order, Nine Container Yard Tractor Trailers:	April 30, 2024
End of 30-day Period for PAG Procurement issuance of Purchase Order, Two 40-Plug Mobile Reefer Generators:	April 30, 2024
Purchase of Two 40-Ton Loaded Container Handlers End Date:	May 1, 2026

Purchase of Three 10-Ton Empty Container Handlers End Date:	May 1, 2026
Purchase of Five 5.5-Ton Forklifts End Date:	May 1, 2026
Purchase of One 180-Ft. Boom Lift End Date:	May 1, 2026
Purchase of Nine Container Yard Tractor Trailers End Date:	May 1, 2026
Purchase of Two 40-Plug Mobile Reefer Generators End Date:	May 1, 2026
Planned Project Substantial Completion Date:	May 1, 2026

**3. Special Milestone Deadlines.**

Milestone	Schedule Date
PAG issues Purchase Order for Two 40-Ton Loaded Container Handlers:	October 31, 2024
PAG issues Purchase Order for Three 10-Ton Empty Container Handlers:	October 31, 2024
PAG issues Purchase Order for Five 5.5-Ton Forklifts:	October 31, 2024
PAG issues Purchase Order for One 180-Ft. Boom Lift:	October 31, 2024
PAG issues Purchase Order for Nine Container Yard Tractor Trailers:	October 31, 2024
PAG issues Purchase Order for Two 40-Plug Mobile Reefer Generators:	October 31, 2024

**SCHEDULE D  
AWARD AND PROJECT FINANCIAL INFORMATION**

**1. Award Amount.**

AMH Grant Amount: \$5,703,560

**2. Federal Obligation Information.**

Federal Obligation Type: Single

**3. Approved Project Budget.**

**Eligible Project Costs**

	<b>AMH Funds:</b>	<b>Non-Federal Funds:</b>	<b>Total</b>
Two 40-Ton Loaded Container Handlers	\$1,704,300	\$985,108	\$2,689,408
Three 10-Ton Empty Container Handlers	\$538,200	\$1,667,523	\$2,205,723
Five 5.5-Ton Forklifts	\$403,650	\$113,850	\$517,500
One 180-Ft. Boom Lift	\$511,290	\$144,210	\$655,500
Nine Container Yard Tractor Trailers	\$1,792,206	\$505,494	\$2,297,700
Two 40-Plug Mobile Reefer Generators	\$717,600	\$202,400	\$920,000
Administrative and legal expenses	\$36,314	\$10,686	\$47,000
<b>Total</b>	<b>\$5,703,560</b>	<b>\$3,629,271</b>	<b>\$9,332,831</b>

**4. Cost Classification Table.**

<b>Cost Classification</b>	<b>Total Costs</b>	<b>Non-AMH Previously Incurred Costs</b>	<b>Eligible Costs</b>
Administrative and legal expenses	\$47,000		\$47,000
Equipment	\$9,285,831		\$9,285,831
<b>Project Total</b>	<b>\$9,332,831</b>		<b>\$9,332,831</b>

**5. Approved Pre-award Costs**

**None.** MARAD has not approved under this award any pre-award costs under 2 C.F.R. 200.458. Because unapproved costs incurred before the date of this agreement are not allowable costs under this award, MARAD will neither reimburse those costs under this award nor consider them as a non-Federal cost sharing contribution to this award. Costs incurred before the date of this agreement are allowable costs under this award only if approved in writing by MARAD before being included in the Project costs and documented in this section 5. See section 13.3(b) of the General Terms and Conditions.

**SCHEDULE E  
CHANGES FROM APPLICATION**

**Scope:** In its application, the Recipient requested \$6,532,092 in AMH Grant funding for the scope of work outlined in this grant agreement, with the addition of two more container yard tractors (for a total of 11 requested). MARAD awarded the Recipient a reduced award of \$5,703,560 because MARAD believes that the Project will deliver sufficient benefits under a reduced scope. This award reduction resulted in the removal of two container yard tractor trailers from the scope and budget and a reduction in the proposed administrative funding amount as a future eligible cost.

**Schedule:** The schedule was updated from that anticipated in the grant application due to the actual date of agreement execution. In its application, the Recipient anticipated entering into a grant agreement by December 31, 2022, with the Project starting January 1, 2023. However, due to the time needed to complete NEPA and negotiate the terms of the grant agreement, the agreement execution was delayed roughly 9 months from that anticipated in the application. Therefore, instead of starting the project January 1, 2023, the Project is now anticipated to begin in August 2023, with completion in May 2026.

**Budget:** As a result of the scope changes noted above, the AMH Grant funding is now \$5,703,560. Despite the scope reduction, the estimated total project cost has increased from \$7,312,700 to \$9,332,831. Since the Recipient's submission of its application, the costs of the two 40-ton loaded container handlers and the three 10-ton empty container handlers have increased to \$2,689,408 and \$2,205,723 respectively due to inflation and increased costs for sourcing domestic equipment. The initial per unit costs in the application of the 40-ton loaded container handlers and the 10-ton empty container handlers were \$1,092,500 and \$230,000 each, respectively. Schedule D is reflective of these increased prices.

The table below provides a summary comparison of the Project budget.

Fund Source	Application		Schedule D	
	\$	%	\$	%
<b>Previously Incurred Costs</b>				
Federal Funds				
Non-Federal Funds				
Total Previously Incurred Costs				
<b>Future Eligible Project Costs</b>				
AMH Funds	\$6,532,092	80%	\$5,703,560	61.1%
Other Federal Funds				
Non-Federal Funds	\$1,633,023	20%	\$3,629,271	38.9%
Total Future Eligible Project Costs	\$8,165,115	100%	\$9,332,831	100%
Total Project Costs	\$8,165,115	100%	\$9,332,831	100%

**SCHEDULE F  
AMH PROGRAM DESIGNATIONS**

**1. Urban or Rural Designation.**

Urban-Rural Designation: Rural

**2. Capital or Planning Designation.**

Capital-Planning Designation: Capital

**3. Historically Disadvantaged Community Designation.**

HDC Designation: Yes

**4. Funding Act.**

IIJA	\$3,581,175
FY2022	\$2,122,385



**SCHEDULE G  
AMH PERFORMANCE MEASUREMENT INFORMATION**

**Study Area:** The Jose D. Leon Guerrero Commercial Port of Guam

**Marine Highway Service:** Shipping service between M-H1 and M-GNM1

**Baseline Measurement Date:** May 1, 2022 – April 30, 2023

**Baseline Report Date:** July 30, 2023

**Table 1: Performance Measure Table**

<b>Measure</b>	<b>Category and Description</b>	<b>Measurement Frequency</b>
<b>Freight Movements</b>	<b>Economic Competitiveness</b>  TEU movements over Project study area	<b>Quarterly</b>

**RECIPIENT SIGNATURE PAGE**

The Recipient, intending to be legally bound, is signing this agreement on the date stated opposite that party's signature.

**PORT AUTHORITY OF GUAM**

August 4, 2023 By:   
Date Signature of Recipient's Authorized Representative

Rory J. Respicio  
\_\_\_\_\_  
Name

General Manager  
\_\_\_\_\_  
Title

**MARAD SIGNATURE PAGE**

MARAD, intending to be legally bound, is signing this agreement on the date stated opposite that party's signature.

**UNITED STATES DEPARTMENT OF  
TRANSPORTATION MARITIME  
ADMINISTRATION**

\_\_\_\_\_ By: \_\_\_\_\_  
Date Signature of MARAD's Authorized Representative

\_\_\_\_\_  
Name

\_\_\_\_\_  
Title

1c

R43500

Port Authority of Guam  
Purchase Order Print

03/06/2024

Page - 1

Order Company 00050

Order Number 21658 000 ON

Shipped From Port Authority of Guam  
1026 Cabras Highway  
Piti GU 96925

Ship To Port Authority of Guam  
1026 Cabras Hywy, Ste 201  
Piti GU

Branch/Plant PAG01

Ordered 10/23/2023 Freight .  
Requested 10/23/2023 Order Taken By Currency Code  
Delivery URGENTLY NEED

Line	Rev	Description /Supplier Item	Ordered	UOM	Unit Price	PU UM	Extended Price	Request Date	Order No	Ty
1.000	0	TELESCOPIC BOOM LIFT	1	EA	655,500.0000	EA	655,500.00	10/23/2023		

TELESCOPIC BOOM LIFT, 180' REACH FULL TIME 4WD

PLEASE SEE ATTACHED BID SPECIFICATIONS AND OTHER DOCUMENTS.

POC:JACQUE CRUZ, RAYMOND SANTOS (671)477-5931/5 EXTENSIONS 295 OR 294.

Total Order 655,500.00

Total Order

Term	Net Due - 30 Days	Tax Rate	*NA*	.00	655,500.00
------	-------------------	----------	------	-----	------------



**Reqs.Awaiting Approval - Work With Approval Status Summary** Personal Form: (No Personalization) Layout: (No Lay

Q X Tools One View

Order Number 21658 ON 00050

Records 1 - 7



<input checked="" type="checkbox"/>	Approval Route Code	Person Responsible	Status	Released Date	Released Time
<input checked="" type="checkbox"/>	PAG10	<b>Budget Approver</b>	Approved	10/23/2023	145506
<input type="checkbox"/>	PAG10	SANTOS, RAYMOND B.	Approved	10/23/2023	152325
<input type="checkbox"/>	PAG10	NELSON, GLENN B.	Approved	10/23/2023	152430
<input type="checkbox"/>	PAG10	BAMBA, VINCENT C.	Approved	10/23/2023	152709
<input type="checkbox"/>	PAG10	PAG Buyer Supervisor	Approved	10/24/2023	83548
<input type="checkbox"/>	PAG10	PAG Buyer Manager	Approved	10/24/2023	110047
<input type="checkbox"/>	PAG10	RESPICIO, RORY J.	Approved	10/24/2023	141318

1d

## Denise

---

**From:** Raymond Bamba <Raymond.Bamba@gsadoa.guam.gov>  
**Sent:** Tuesday, November 07, 2023 8:27 AM  
**To:** Denise  
**Subject:** RE: Tenda Availability 180 Boom Lift Bid

Hi Denise,

This item is unavailable.

Ray

---

**From:** Denise <djcalvo@portofguam.com>  
**Sent:** Monday, November 6, 2023 4:16 PM  
**To:** Raymond Bamba <Raymond.Bamba@gsadoa.guam.gov>  
**Cc:** 'PAG Procurement' <pagprocurement@portofguam.com>  
**Subject:** Tenda Availability 180 Boom Lift Bid

**CAUTION:** This email originated from outside of the Government's Network. Do not click links or open attachments unless you recognize the sender and know the content is safe.

H Hi Mr. Ray,

I hope all is well. Please let me know if the attached bid line items are available in Tenda.  
Please see the file attached.

If you have any questions, please let me know.

Thank you,

Denise



1e

ITEM NO.	DESCRIPTION	QUANTITY	UNIT	UNIT PRICE	EXTENSION
1.1	Telescopic Boom Lift, 180' Reach Full time 4WD		1 EA.	\$ _____	\$ _____

**GENERAL:** These specifications have been written, to describe minimum equipment and performance requirements to be supplied by the equipment manufacture bidding. Reasonable test may be conducted upon delivery before acceptance.

The successful bidder shall furnish all necessary and desirable information and instructions for the proper operation of the equipment.

The government reserves the right to accept and/or reject any and all bids, to waive any defects, Irregularities, or specification discrepancies and to award the bid as council deems to be in the best interest of the government.

**DISCREPANCIES**

**LISTED:** Should any bidder have deviations from these specifications in his bid and cannot meet every requirement of the specifications, he shall submit a letter and attach it to the bid, explaining the deviations, failure to do so will cause the bid to be rejected as being non-responsive.

**DELIVER:** The successful bidder shall deliver one (1) 180' Boom Lift each be new fully assembled and ready for operation to the Port Authority of Guam within 120 days.

**SPECIFICATIONS:**

**BIDDING AND OR REMARKS:**

**Engine:** 74 hp minimum,  
Diesel Engine  
Engine shutoff protection system  
(Low Oil Pressure, High Engine Temperature  
High Transmission Temperature)

\_\_\_\_\_

**Fuel Type:** Diesel (Ultra Low Sulfur) Tier IV

\_\_\_\_\_

**Fuel Tank:** The fuel tank furnished shall be Min. 50 gallon

-----

**Platform reach:** 180ft & 10ft jib

\_\_\_\_\_

**Platform Dimensions:**

36 x 96 with railing & side entry

-----

**Platform Capacity:**

Unrestricted - 500 lbs

\_\_\_\_\_

Restricted - 750 lbs

\_\_\_\_\_

**Platform Rotation:**

160 degrees

\_\_\_\_\_

**Swing:** 360 degrees continuous \_\_\_\_\_

**Steering:** Selectable Steering (ground level or platform) \_\_\_\_\_

**Axles:** Extendable front and rear \_\_\_\_\_

**Gauges:** Air, Fuel, Hour, Volt, Temp, and Oil \_\_\_\_\_

**Lights:** 2 Headlights in facing forward with protective guard,  
2 Headlights facing rear with protective guard.  
2 work lights on platform \_\_\_\_\_

**Tires:** Protector Lug Foam Filled tires \_\_\_\_\_

**Manlift Accessories:**  
Platform to be plumbed with air lines for use of pneumatic  
Tools \_\_\_\_\_

Hostile Weather/Environment Kit \_\_\_\_\_

AC plug/outlet in platform \_\_\_\_\_

**Accessories:** Standard manufacture accessories' to include  
Horn - Electric \_\_\_\_\_  
Amber strobe light, key switch "on position" activated. \_\_\_\_\_  
Mounted 5 lbs. fire extinguisher on platform \_\_\_\_\_  
1 set "Shop Type" repair manuals and complete \_\_\_\_\_  
illustrated parts manual. \_\_\_\_\_  
Diagnostic and Troubleshooting software \_\_\_\_\_  
Owner/Operator manual for each equipment \_\_\_\_\_  
Maintenance and Service manual for each equipment \_\_\_\_\_  
Warranty booklet for each equipment \_\_\_\_\_  
Recommended spare parts list \_\_\_\_\_  
All fluids to the fullest level \_\_\_\_\_  
Fuel tank to be loaded with 10 gallons of diesel. \_\_\_\_\_  
Electronic Backup alarm \_\_\_\_\_  
Engine shut-off protection system (Low Oil Pressure, \_\_\_\_\_  
High Engine Temperature and High Transmission \_\_\_\_\_  
Temperatures), \_\_\_\_\_  
Reflective Conspicuity Tape \_\_\_\_\_  
Electronic rust prevention system \_\_\_\_\_

**Receiving Date:** (Acceptance Date) will be Three (3) days after delivery  
Date, provided the Equipment is Delivered Completely  
Assembled and meets all specifications, terms and  
conditions of the bid requirements. \_\_\_\_\_

**Special**

**Provision:** If parts catalog and maintenance repair comes in CD-ROM or Microfiche, bidder must supply to requesting agency. Bidder must still provide hard (book) copy to the requesting agency.

---

**Applicable  
Federal Laws  
And  
Regulations:**

Buy American Act – 41 U.S.C § 8301-8305  
Build America Buy America Act Certificate must be provide by the manufacture.

---

**Training:** Provide 2 sessions on pre inspection, post inspection and safe operational procedures for all operators, leaders, supervisors and dispatchers within Maintenance division.

---

**Warranty:** Manufacturers Standard Warranty, 1 year limited warranty. Service of one (1) year/ 2,000 hours, all parts, labor and oil disposal shall be included at "No Cost to the Government".

Yes, offer as requested. \_\_\_\_\_

No, Offer the following: \_\_\_\_\_

The manufacturer Warranty and Boucher shall be specified on items covered and provided in the bid packet. (Bid submission received without written warranty and Boucher as specified will be rejected).

Yes, offer as requested. \_\_\_\_\_

No, Offer the following: \_\_\_\_\_

The successful bidder shall provide technical assistance and warranty administration without any cost to "The Port Authority of Guam"

Yes, offer as requested. \_\_\_\_\_

No, Offer the following: \_\_\_\_\_

The successful bidder shall provide service, such as to determine deficiency, repair or adjustment of the equipment on government premises or transfer the equipment to the shop where the repair should be done, at anytime within the warranty period and at "No cost to the Government". When the equipment is down for warranty repair(s) and remain in shop for a certain period awaiting part(s) and or material(s), the total down-time period shall be extended to the service and warranty period.

Yes, offer as requested. \_\_\_\_\_

No, Offer the following: \_\_\_\_\_

The manufacture shall have a local authorized dealer who can provide factory trained service technician(s). Bidder shall provide certification of factory trained technician(s) for the above equipments be purchased during commissioning. Failure to provided will result as "Unacceptable".

Yes, offer as requested. \_\_\_\_\_

No, Offer the following: \_\_\_\_\_

Provide Complete Familiarization Training to Port Representatives on maintenance of Mechanical, Electrical and Hydraulic systems on units by manufacturer. All costs Associated with training (airfare, lodging and transportation) are to be included At no cost to the Government of Guam.

Yes, offer as requested. \_\_\_\_\_

No, Offer the following: \_\_\_\_\_

**Notes: Bidder shall identify on their bids, any deviations from the specifications or requirements in the remarks column and state item being offered for evaluation processing. Failure to comply may result in rejection of bid.**

**Certificate of Origin is required on sale of the vehicle.**

**Equipment must be delivered to Port Authority of Guam for inspection.**

1.2 Bidding on : Telescopic Boom Lift 180' reach, Full time 4WD

MANUFACTURER: \_\_\_\_\_

MAKE: \_\_\_\_\_

MODEL: \_\_\_\_\_

YEAR: \_\_\_\_\_

PLACE OF ORIGIN: \_\_\_\_\_

DATE OF DELIVERY: \_\_\_\_\_

REVEIUED BY:

 \_\_\_\_\_

Acting Superintendent T.M.D  
Department of Public Works

DATE: 10-19-23



1f





**PORT OF GUAM**  
ATURIDAT I PUETTON GUAHAN  
Jose D. Leon Guerrero Commercial Port  
1026 Cabras Highway, Suite 201, Piti, Guam 96915  
Telephone: 671-477-5931/35 Facsimile: 671-477-2689/4445  
Website: [www.portguam.com](http://www.portguam.com)



Lourdes A. Leon Guerrero  
Governor of Guam  
Joshua F. Tenorio  
Lieutenant Governor

## DETERMINATION OF NEED FOR SOLICITATION THROUGH AN IFB

December 27, 2023

### MEMORANDUM

TO: Procurement Record  
FROM: Procurement Officer  
RE: Port Authority of Guam IFB-PAG-004-24 re: Procurement of 180' Telescopic Boom Lift  
SUBJECT: Determination of Need for Solicitation Through and IFB

#### STATEMENT OF FINDINGS:

1. This Determination of Need is issued pursuant to 5 GCA § 5249(e) which requires a written Determination of Need justifying the use of competitive selection procedures.
2. The Port Authority of Guam (PAG) is required to have equipment that has a minimum reach of 180' to maintain its gantry cranes, a Telescopic Boom Lift with such reach is needed in order satisfy the Port Authority of Guam's objectives.
3. This requires a 180' Telescopic Boom Lift, which is best acquired through the use of a competitive procurement.
4. A reasonable inquiry has been conducted pursuant to 5 GCA § 5130(d) verifying that the items to be procured are not available as surplus. [Written verification has been obtained from the General Services Agency validating that the items intend for purchase are not available from governmental sources and need to be procured by the Port.
5. Therefore, the Port needs to procure a 180' Telescopic Boom Lift.
6. Wherefore, the Port intends to issue an IFB to solicit the purchase of a 180' telescopic boom lift under a contract that allows an individual or company to provide a telescopic boom lift because the in-house capabilities of the Port are insufficient to fulfill this need. It is more economical to obtain such lift by contract, and such a contract is in the public's best interest.
7. The estimated total cost over the life of this contract is \$655,500.
8. Funding (is/is not yet) available for this contract. The source of the funds is MARAD FY2022 American Marine Highway Grant No. 693JF72340007

**CONCLUSIONS:**

1. The Director of the Port Authority of Guam has determined that the PAG has a need to acquire the 180' Telescopic Boom Lift from outside sources.
2. The Port finds that it is necessary to issue an Invitation for Bid ("IFB") to obtain bids from prospective individuals and companies to obtain the 180' Telescopic Boom Lift, in a fashion that satisfies the Port's objectives.
3. The Port proposes to allow a contractor to provide work for a term up to fifteen months including all options or extensions. March 30, 2025 is the estimated termination date of the contract.
4. A contract will be prepared and attached to the IFB. The proposed contract will leave room for open competition after a reasonable amount of time has passed under the circumstances of the IFB.
5. The Port has developed, and fully intends to implement, a plan for utilizing the items or work procured, which plan will be included in the specifications or contractual statement of work.



---

Rory J. Respicio,  
General Manager/ Procurement Officer  
Port Authority of Guam

**DECLARATION RE COMPLIANCE WITH 5 GCA § 5150**

I, RORY J. RESPICIO, make this declaration on 10/23/2023  
*[print name clearly]* *[enter today's date]*  
 regarding Procurement No. REQ#: 21658-ON, and do hereby **certify under penalty of perjury** that:  
*[enter procurement no.]*

(1) I am the procurement officer (Chief Procurement Officer, Director of Public Works, or head of a purchasing agency) for this procurement,

(2) I have caused an estimate to be made of the cost of the services or supplies being procured, and for which a contract will be entered into or a purchase order will be issued, whichever is appropriate as the case may be;

(3) My estimate of the total cost of the contract or purchase order, whichever is appropriate as the case may be, is *[please check one]*:

- less than \$500,000; or
- \$500,000 or more;

(4) If the total estimated cost of the procurement is \$500,000 or more, I understand that I must be advised by legal counsel designated by the Attorney General (which may be an Assistant Attorney General or other legal counsel designated as Special Assistant Attorney General ("SAAG") under 5 GCA § 5150) during each and every phase of the procurement process, beginning with the planning stage and before any request for proposal or invitation to bid is issued or notice published, or before any sole source procurement or emergency procurement is undertaken;

(5) If the total estimated cost of the procurement is \$500,000 or more, I understand I may not proceed with any phase of the procurement unless I have been advised by an Assistant Attorney General or a SAAG to proceed;

(6) If the total estimated cost of the procurement is less than \$500,000 initially when the procurement is begun, but the total cost increases to \$500,000 or more at some later point in time, I understand I must contact the Attorney General's Office as soon as I become aware that the procurement will actually cost \$500,000 or more, and that I may not proceed further without the assistance of the Attorney General's Office or a SAAG; and

(7) I understand if I do not comply with the requirements of 5 GCA § 5150 and the Attorney General's Office or a SAAG has not acted as legal counsel during all phases of a procurement estimated to cost \$500,000 or more, the Attorney General or SAAG may disapprove the contract, or the procurement may be subject to cancellation, or any award, contract or purchase order made or entered into may be subject to termination.

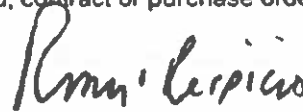

RORY J. RESPICIO

*[Declarant's Signature]*

## DETERMINATION OF NEED

### 180' Boom Lift

The Port Authority of Guam operates the only commercial seaport on Territory and as the primary seaport in Micronesia, serves as a transshipment port for the entire Western Pacific Region. It operates the largest U.S. deep water seaport in the Western Pacific Region and currently handles over 2 million tons of cargo a year. The Port owns, operates and maintains various cargo handling equipment to move cargoes and to support the maintenance of other cargo handling equipment's.

The Port Authority of Guam's Maintenance Department requires a 180-foot boom lift for various types of maintenance. This is the only possible way for Facility Maintenance to repair all high mast lighting for the entire terminal yard. The lift provides maintenance to access unreachable areas on our 3 Gantry Cranes for any corrosion and welding repairs. Without the ability to conduct such repairs would reduce the life span of our already aging cranes and cause significant safety concerns.



\_\_\_\_\_  
Rory J. Resepcio, General Manager



\_\_\_\_\_  
Date

2a

# THE GUAM DAILY POST

388 S. Marine Corps. Dr., Ste. 301, Tamuning, Guam 96913

Phone: (671) 649 -1924 Fax: (671) 648-2007

E-mail: miriam@postguam.com

Website: www.postguam.com

## Advertising Order / Invoice

Date	1/23/2024
A.O. No.	A92364
Due Date	2/19/2024
P.O. No.	193020S

**Advertiser / Address**

**Port Authority of Guam**  
 1026 Cabras Highway Suite 201  
 Piti, Guam 96925

**Sales Rep**

Miriam Rupley

**Ad place through**

Mark Cabrera - macabrera@portofguam.com / 671-477-5931 ext. 252

Item	AD Description	BW / Color	Run Date(s)	Col(s)	In(s)	Rate	Amount
Government	IFB-PAG-004-24 180' Telescopic Boom Lift	BW	1/26/2024	2	4	224.00	224.00

<b>Total</b>	<b>\$</b>	<b>224.00</b>
<b>Payments/Credits</b>	<b>\$</b>	<b>-</b>
<b>Balance Due</b>	<b>\$</b>	<b>224.00</b>

**TERMS AND CONDITIONS**

**EXPEDITED ORDER FEE** Any advertisement ordered one (1) day before the specified publication date will be assessed for an additional \$250.00.

**LATE CANCELLATION FEE** Any advertisement cancelled one (1) day before the specified publication date will be assessed \$250.00.

**AD LAYOUT FEE** Any artwork requested from The Guam Daily Post (excluding classified advertisements) will be assessed a \$150.00 per hour artwork fee.

**PREFERRED PLACEMENT** Preferred Placement The Guam Daily Post does not guarantee any requested placement of advertisements. Any request for preferred placement will be taken into consideration but will not affect this agreement if the preferred placement is not delivered.

**PAYMENT** Contract submission & 50% payment due at least 3 days prior to ad placement. Prior to publication, a 50% down payment is required upon ad space reservation. Please make checks payable to "Guam Daily Post LLC" and remit payment to 388 S. Marine Corps Drive, Suite 301, Tamuning, Guam 96913. For credit card payment(s), there is an additional 4% charge applied when paying with American Express (AMEX) - credit card payments may also be accepted via telecom via (671) 649-1924. All accounts must be paid within 10 days from the due date appearing on the invoice. Advertiser(s) understands and agrees that late fees of 1.5% per month on all accounts remaining unpaid after 30 days from the original run date. A fee of \$50.00 for the NSF check. If referred to a collection agency, a 33 1/3% of the amount found due shall be added to the same as collection fees. All accounts must be paid within 10 days from the due date appearing on the invoice.

Advertiser(s) understands and agrees that late fees of 1.5% per month on all accounts remaining unpaid after 30 days from the original run date. A fee of \$50.00 for the NSF check. If referred to a collection agency, a 33 1/3% of the amount found due shall be added to the same as collection fees. The advertiser(s)/ad agency jointly and severally agree to indemnify and hold The Guam Daily Post harmless against any damages and expenses of any nature incurred by The Guam Daily Post arising out of the publication of material appearing in advertisement submitted by them for the public including, but not limited to, The Guam Daily Post's defense against any suit or proceeding arising from a claim that publication of material appearing in advertisements submitted to it for publication was in violation of rights of others or law imposed by the United States or by any state, territory, or subdivision thereof.

The Guam Daily Post shall have no liability to an advertiser and/or agency because of a failure to complete accepted advertising orders because of acts of God, strikes, work stoppages, fire, accidents, postal delays, or any other circumstance of whatever nature beyond its control. Under no circumstances shall The Guam Daily Post direct or indirect liability to an advertiser and/or agency exceed the invoiced cost of the advertisement. The Guam Daily Post shall have the right to require payment for advertising upon such terms as The Guam Daily Post sees fit prior to publication of any ordered advertisement. The Guam Daily Post reserves the right to cancel the contract at any time upon default in the payment of bills. In the event of such cancellation, charges for all advertising published shall become immediately due and payable.

Furthermore, if there has been any default in the payment of the prior bill, or if, in the sole judgment of The Guam Daily Post, credit becomes impaired, The Guam Daily Post shall have the right to require full payment for further advertising under his/her contract upon such terms as The Guam Daily Post sees fit. Advertiser(s)/ad agency are jointly and severally liable for payment to The Guam Daily Post.

Authorized Name Mark Cabrera  
 Authorized Signature [Signature]  
 Date 1/24/2024

**Thank you for your business!**

Please make payment to GUAM DAILY POST, LLC.

[https://www.postguam.com/site/forms/subscription\\_services/paybill/](https://www.postguam.com/site/forms/subscription_services/paybill/)





**PORT OF GUAM**  
ATURIDATI PUETTON GUAHAN  
Jose D. Leon Guerrero Commercial Port  
1026 Cabras Highway, Suite 201, Piti, Guam 96915  
Telephone: 671-477-5931/35 Facsimile: 671-477-2689/4445  
Website: [www.portguam.com](http://www.portguam.com)



**Lourdes A. Leon Guerrero**  
Governor of Guam  
**Joshua F. Tenorio**  
Lieutenant Governor

## **INVITATION FOR BID:**

**BID NO:**

**IFB-PAG-004-24**

**FOR:**

**180' Telescopic Boom Lift**

**BID SUBMISSION DEADLINE:**

**2:00 p.m., FRIDAY, February 16, 2024**

**LOCATION TO SUBMIT:**

**PAG PROCUREMENT OFFICE, 1st FLOOR, ADMIN. BLDG.**

**BID OPENING LOCATION:**

**PAG BOARD OF DIRECTORS CONFERENCE ROOM, 1st FLOOR, ADMIN. BLDG.**

The Port Authority of Guam (PAG) is issuing an Invitation for Bid for 180' Telescopic Boom Lift. A PDF copy of the bid packet is available for download at [www.portofguam.com](http://www.portofguam.com), or a hard copy can be obtained at the PAG Procurement Office located on the 1st floor of the PAG Admin Bldg. from 8:00 a.m. - 5:00 p.m., Monday through Friday, beginning Friday, January 26, 2024 until Friday, February 16, 2024.

Bidders must register their current contact information with PAG to ensure they receive any notices regarding changes or updates to the IFB. The Port will not be liable for failure to provide notice to any party who did not register current contact information.

The PAG reserves the right, in its sole and absolute discretion, to reject any and all bids, cancel in its entirety, or waive informalities and minor irregularities in the bids, which in its sole and absolute judgment, will under all circumstances best serve the Government's interests. This right to reject and/or cancel is pursuant to 2 GAR Div. 4 Procurement Regulations § 3115 (d)(2)(A). This project is funded by the Port Authority of Guam.

This project is funded by MARAD FY2022 American Marine Highway Grant No. 693JF72340007

**/s/ RORY J. RESPICIO**  
General Manager

**THIS ADVERTISEMENT WAS PAID WITH GOVERNMENT FUNDS: PORT AUTHORITY OF GUAM**



2b

**BAUMANN, XU and BLACK, LLC**  
 238 Archbishop Flores St. Suite 903  
 Hagåtña, Guam 96910  
 Telephone: (671) 477-9084  
 Fax: (671) 477-9087

**IN THE SUPERIOR COURT OF GUAM  
 IN THE MATTER OF THE ESTATE OF  
 JOSE SANTOS SANTOS and SYLVIA  
 IGLESIAS SANTOS,**  
 Deceased.  
 by  
**NEERAJ NAGARAJAN,**  
 Petitioner.

**PROBATE CASE NO. PRO218-23  
 NOTICE OF HEARING ON PETITION  
 FOR LETTERS OF ADMINISTRATION**

NOTICE IS HEREBY GIVEN that NEERAJ NAGARAJAN has filed herein a Petition for Letters of Administration upon the Estates of JOSE SANTOS SANTOS and SYLVIA IGLESIAS SANTOS, deceased, and that on February 6, 2024, at 11:00 a.m., of said day in the courtroom of the Superior Court of Guam, Hagåtña, Guam, has been set for hearing of said petition and all persons interested are hereby noticed to appear at the time and place set for said hearing and show cause if any they have why the petition should not be granted.

Reference is hereby made to the said petition for further particulars.

Dated: January 2, 2024

**ZOOM INFO**  
 Meeting ID: 752 425 5848  
 Passcode: JARB

**SOPHIA SANTOS DIAZ**  
 Clerk of Court  
 By: /s/ Yvonne L. Cruz  
 Chamber/Courtroom Clerk

**You in trouble?**  
 I buy houses, condos, lots  
 Wallace 671-687-5863 PPM BRK

**ZERO DOWNPAYMENT!**  
 Santa Rita ½ Acre Lot. \$35k  
 Talofofu OWNER FINANCING  
 House Lot w/ Sewer Nearby - \$50k  
 Macheche OWNER FINANCING  
 ½- Acre Lot. City View - \$120k  
 Call Wallace "The World" Roberto  
 (671) 687-5863 PPM BRK

**Mangilao Lot Rte 10 Frontage**  
 Next to Upcoming McDonald's  
 \$1,500 mo. For Lease

**Merizo 1/4-Acre Lot.**  
 Quiet. Neighbors around. \$40k

Call Wallace "The World" Roberto  
 (671) 687-5863 PPM BRK

**Kumision I Tano' Saina-ta'  
 Guam Ancestral Lands Commission**

The Guam Ancestral Lands Commission Special Board Meeting will be held on **Tuesday, January 30, 2024 at 2:00 pm.** This meeting is open to the public via ZOOM and can be viewed live streamed on YouTube at Guam Ancestral Lands Commission-GALC channel.

**JOIN ZOOM MEETING**  
<https://us02web.zoom.us/j/8706936269?pwd=dVU2MzNWMXg0a1ZlcUJlJ0RoUT09>  
 Meeting ID: 870 693 6269      Passcode: 2022

**TO VIEW LIVE STREAMING**  
[https://www.youtube.com/watch?v=UCv1mv3dhTHiG4\\_wnsSVH03g](https://www.youtube.com/watch?v=UCv1mv3dhTHiG4_wnsSVH03g)

**AGENDA**  
 I. Call to Order; II. Roll Call; III. Northern Market - Counter proposal; IV. Adjournment

Individuals requiring special accommodations, auxiliary aids or services, may contact Guam Ancestral Lands Commission at 671-473-5263 or email [admin@galc.guam.goy](mailto:admin@galc.guam.goy).

This ad is paid for by GALC Survey, Infrastructure & Development Funds.

**RAY CRUZ HADDOCK, ESQ.  
 PACIFIC LAW PROFESSIONALS, PLLC**  
 277 Chalan Santo Papa  
 Hagåtña, Guam 96910  
 Telephone: 671-477-0000  
 Facsimile No: 671-477-0001  
 Attorneys for Petitioner

**IN THE SUPERIOR COURT OF GUAM  
 IN THE MATTER OF THE ESTATE  
 OF**

**VICTOR FRANCISCO BLAS,**  
 Deceased.  
**PROBATE CASE NO. PRO205-23  
 NOTICE TO CREDITORS**

Notice is given by the undersigned, Mari D. Blas, Administratrix of the Estate of VICTOR FRANCISCO BLAS, deceased, to the creditors of, and all persons having claims against the said estate or against said decedent, that within (60) days after the first publication of this notice, they either file their claims in the office of the Clerk of the Superior Court of Guam, or exhibit them with the necessary vouchers to PACIFIC LAW PROFESSIONALS, PLLC 277 Chalan Santo Papa Hagåtña Guam 96910, the same being the place for the transaction of the business of said Estate.

Dated: 01/12/2024

/s/ Mari D. Blas  
 Administratrix

**BAUMANN, XU and BLACK, LLC**  
 238 Archbishop Flores St. Suite 903  
 Hagåtña, Guam 96910  
 Telephone: (671) 477-9084  
 Fax: (671) 477-9087

**IN THE SUPERIOR COURT OF GUAM  
 UNIVERSITY OF GUAM ENDOWMENT  
 FOUNDATION, INC., A Guam Non-Profit  
 Corporation,  
 Plaintiff,  
 vs.  
 THE ESTATE OF GREGORIO G.  
 SABLAN AND FRANCISCA Q.  
 SABLAN, and DOES I through L, all persons  
 unknown claiming any legal or equitable right,  
 title, estate, lien or interest in the property  
 described in the Complaint adverse to Plaintiff's  
 title, or any cloud upon Plaintiff's title thereto,  
 Defendants.**

**CIVIL CASE NO. CV0674-22  
 SUMMONS**

TO THE ABOVE-NAMED DEFENDANT: THE ESTATE OF GREGORIO G. SABLAN AND FRANCISCA Q. SABLAN  
 160 Taigigao St. Agaña Heights, Guam

YOU ARE HEREBY SUMMONED and directed to file with this Court and to serve upon Shane F.I. Black, Esq., BAUMANN, XU and BLACK, LLC, 238 Archbishop Flores Street, Suite 903, Hagåtña, Guam, a written answer to the Verified Complaint to Quiet Title to Real Property which is herewith served upon you, within twenty (20) days after service of this Summons upon you (exclusive of the day of service).

YOU ARE HEREBY NOTIFIED that should you fail to appear and answer to said Complaint as required above, and in the manner prescribed by law, the Plaintiff will cause your default to be entered and will apply to the court for relief prayed for in the Complaint.

**DANIELLE T. ROSETE**  
 Clerk of Court, Superior Court of Guam  
 By: /s/ SCOTT E. HERMOSILLA  
 Deputy Clerk

**JOB ANNOUNCEMENT FOR TEMPORARY POSITIONS**

38 - Carpenter (1 yr. exp.)  
 15 - Cement Mason (1 yr. exp.)  
 15 - Electrician (2 yrs. exp.)  
 9 - Heavy Equipment Operator (1 yr. exp.)  
 15 - HVAC & Refrigeration Mechanic (2 yrs. exp.)  
 15 - Painter (1 yr. exp.)  
 15 - Plumber (2 yrs. exp.)  
 38 - Reinforcing Metal Worker (1 yr. exp.)

**Apply at Pacific Federal Management, Inc.  
 by calling (671) 989-8542 Mon-Fri between 2 p.m. and 4 p.m.  
 References required upon request.**

**PORT OF GUAM**  
 ATURIDAT / PUEYTON GAUHAN  
 Jose D. Leon Guerrero Commercial Port  
 1026 Carlos Highway, Suite 201, P.O. Box 96915  
 Telephone: 671-477-5931/35 Facsimile: 671-477-2689/4445  
 Website: [www.portofguam.com](http://www.portofguam.com)

**LOURDES A. LEON GUERRERO**  
 Governor of Guam  
**JOSHUA F. TENORIO**  
 Lieutenant Governor

**INVITATION FOR BID:**

**BID NO:** IFB-PAG-004-24  
**FOR:** 180' Telescopic Boom Lift  
**BID SUBMISSION DEADLINE:** 2:00 p.m., FRIDAY, February 16, 2024  
**LOCATION TO SUBMIT:** PAG PROCUREMENT OFFICE, 1st FLOOR, ADMIN. BLDG.  
**BID OPENING LOCATION:** PAG BOARD OF DIRECTORS CONFERENCE ROOM, 1st FLOOR, ADMIN. BLDG.

The Port Authority of Guam (PAG) is issuing an Invitation for Bid for 180' Telescopic Boom Lift. A PDF copy of the bid packet is available for download at [www.portofguam.com](http://www.portofguam.com), or a hard copy can be obtained at the PAG Procurement Office located on the 1st floor of the PAG Admin Bldg. from 8:00 a.m. - 5:00 p.m., Monday through Friday, beginning Friday, January 26, 2024 until Friday, February 16, 2024.

Bidders must register their current contact information with PAG to ensure they receive any notices regarding changes or updates to the IFB. The Port will not be liable for failure to provide notice to any party who did not register current contact information.

The PAG reserves the right, in its sole and absolute discretion, to reject any and all bids, cancel in its entirety, or waive informality and minor irregularities in the bids, which in its sole and absolute judgment, will under all circumstances best serve the Government's interests. This right to reject and/or cancel is pursuant to 2 GAR Div. 4 Procurement Regulations § 3115 (d)(2)(A). This project is funded by the Port Authority of Guam.

This project is funded by MARAD FY2022 American Marine Highway Grant No. 693JF72340007

/s/ RORY J. RESPICIO  
 General Manager

THIS ADVERTISEMENT WAS PAID WITH GOVERNMENT FUNDS: PORT AUTHORITY OF GUAM

**LOURDES A. LEON GUERRERO, Governor**  
 Joshua F. Tenorio, Lieutenant Governor

**JOSE A. SAN AGUSTIN, USME (Ret.) Director**

**GUAM VETERANS COMMISSION**  
**FRIDAY, 02 FEBRUARY 2024  
 1600 HRS**

**LARGE CONFERENCE ROOM, ADELUP**  
<https://us02web.zoom.us/j/88546391376?pwd=N3g3MlYkZlZ1JvbGFOb1Q0cnk3UT09>

Broadcast live stream: <https://www.facebook.com/GuahanVeterans671>

**AGENDA**

I. CALL TO ORDER  
 II. PLEDGE OF ALLEGIANCE  
 III. ATTENDANCE  
 IV. ACKNOWLEDGEMENT OF PUBLIC NOTICE: (29 JAN. & 31 JAN. 2024)  
 V. APPROVAL OF AGENDA: 02 FEBRUARY 2024  
 VI. NEW BUSINESS: Guam Veterans Commission Officers  
 A. House rules regarding nomination process  
 B. First round of nominations  
 C. Discussion regarding March 2024- Second round of nominations  
 D. Official election of officers  
 VII. ANNOUNCEMENTS  
 VII. NEXT MEETING: 22 MARCH 2024 @ 1500 HRS  
 IX. ADJOURN

Advertisement paid for by ARP funds- American Rescue Plan: USPL117-2

For more information and persons requiring special accommodations, please contact Guam Office of Veterans Affairs- Administrative Officer, Joseph Meno, at 671-475-8388 or email at [joseph.meno@gvao.guam.goy](mailto:joseph.meno@gvao.guam.goy)

3a



**PORT OF GUAM**  
 ATURIDAT I PUETTON GUAHAN  
**Jose D. Leon Guerrero Commercial Port**  
 1026 Cabras Highway, Suite 201, Piti, Guam 96915  
 Telephone: 671-477-5931/35 Facsimile: 671-477-2689/4445  
 Website: www.portguam.com



**Lourdes A. Leon Guerrero**  
 Governor of Guam  
**Joshua F. Tenorio**  
 Lieutenant Governor

Accountability \* Impartiality \* Competence \* Openness \* Value

**INVITATION FOR BID NO.: IFB PAG-004-24**

**DESCRIPTION:**  
**180' Telescopic Boom Lift**

**SPECIAL REMINDER TO PROSPECTIVE BIDDERS**

Bidders are reminded to read the Sealed Bid Solicitation and Instructions, and General Terms and Conditions attached to the IFB to ascertain that all of the following requirements checked below are submitted in the bid envelope, in duplicate (one marked original with other marked copy), and (1) CD or USB containing electronic file copy in PDF format, at the date and time for bid opening.

- [X] BID GUARANTEE (15% of Bid Amount) May be in the form of;  
**Reference #11 on the General Terms and Conditions**
  - a. Cashier's Check or Certified Check
  - b. Letter of Credit
  - c. Surety Bond – Valid only if accompanied by:
    - 1. Current Certificate of Authority issued by the Insurance Commissioner;
    - 2. Power of Attorney issued by the Surety to the Resident General Agent;
    - 3. Power of Attorney issued by two (2) major officers of the Surety to whoever is signing on their behalf.
  
- [X] BROCHURES/DESCRIPTIVE LITERATURE;
  
- [X] AFFIDAVIT DISCLOSING OWNERSHIP and COMMISSION
  - a. Date of signature of the person authorized to sign the bid and the notary date must be the same.
  
- [X] OTHER REQUIREMENTS:  
Disclosure of Shareholder & Commission, Non-Collusion Declaration, D.O.L. Wage Determination Declaration, Restriction against Sexual Offenders Declaration, No Kickbacks or Gratuities Declaration and Ethical Standards Declaration, and Declaration re Contingent Fees, Conflict of Interest Form, SF-LLL Byrd Anti-Lobbying, and Business License- must be current at the time of award.

**This reminder must be signed and returned in the bid envelope together with the bid. Failure to comply with the above requirements may be cause for disqualification and rejection of the bid.**

On this \_\_\_\_\_ day of \_\_\_\_\_, 2024, I, \_\_\_\_\_,

authorized representative of \_\_\_\_\_ acknowledge receipt of this special reminder to prospective bidders with the above referenced IFB.

\_\_\_\_\_  
 Bidder Representative's Signature

INVITATION FOR BID NO.: IFB-PAG-004-24

**180' Telescopic Boom Lift**

**ACKNOWLEDGEMENT RECEIPT FORM**

Please be advised that to be considered a prospective bidder you must fill out this Acknowledgement receipt form. Please submit by fax form to (671) 472-1439 or email to :[macabrera@portofguam.com](mailto:macabrera@portofguam.com), and [pagprocurement@portofguam.com](mailto:pagprocurement@portofguam.com)

**Acknowledgement Receipt Form must be submitted no later than three (3) days upon receipt of IFB package.**

**Name** \_\_\_\_\_

**Signature** \_\_\_\_\_

**Date** \_\_\_\_\_

**Time** \_\_\_\_\_

**Contact Number** \_\_\_\_\_

**Fax Number** \_\_\_\_\_

**Contact Person regarding IFB** \_\_\_\_\_

**Title** \_\_\_\_\_

**E-Mail Address** \_\_\_\_\_

**Company/Firm** \_\_\_\_\_

**Address** \_\_\_\_\_

Note: IFB recommends that prospective bidders register current contact information with IFB to ensure they receive any notices regarding any changes or update to the IFB. The procuring agency and IFB will not be liable for failure to provide notice to any party who did not register current contact information.

All questions and concerns in regards to this bid must be submitted to the PORT AUTHORITY OF GUAM via fax or email, addressed to the GENERAL MANAGER no later than Friday, February 9, 2024 by the close of business at 5:00pm. Your inquiry may be sent by fax to (671)472-1439, or emailed to [rjrespicio@portofguam.com](mailto:rjrespicio@portofguam.com) and copied to [pagprocurement@portofguam.com](mailto:pagprocurement@portofguam.com) , [algsablan@portofguam.com](mailto:algsablan@portofguam.com), and [macabrera@portofguam.com](mailto:macabrera@portofguam.com).

No entitlement to Preparation Costs- The bidder expressly waives any right it may have against the government for any expenses incurred in connection with the preparation of its bid.

**INVITATION FOR BID**

*Rory Respicio*

ISSUING OFFICE:  
PORT AUTHORITY OF GUAM  
GOVERNMENT OF GUAM  
1026 CABRAS HIGHWAY, SUITE 201,  
PITI, GUAM 96915

RORY J. RESPICIO  
GENERAL MANAGER

DATE ISSUED: January 26, 2024

BID INVITATION NO: **IFB/PAG-004-24**

BID FOR: **180' Telescopic Boom Lift**

SPECIFICATION: **SEE BELOW**

DESTINATION: **PORT AUTHORITY OF GUAM**

REQUIRED DELIVERY DATE: (460 days ARO) upon receipt of purchase order. Delivery schedule time and quantity will be coordinated between the successful bidder and the requesting department in accordance with the schedules contained in MARAD FY2022 American Marine Highway (AMH) Grant No. 693JF72340007, and in accordance with the expiration date of this grant, currently set to expire on May 1, 2026. This project is funded by the MARAD FY2022 American Marine Highway (AMH) Grant No.: 693JF72340007.

INSTRUCTION TO BIDDERS:

INDICATE WHETHER:  INDIVIDUAL  PARTNERSHIP  CORPORATION

INCORPORATED IN: \_\_\_\_\_

Each bid shall be submitted in duplicate with electronic copy (pdf format) on CD or thumb drive and sealed inside the envelope when submitting to the issuing office above no later than (Time) **2:00 PM** Date: **FRIDAY, February 16, 2024** and shall be publicly opened. Any bid submitted after the time and date specified above shall be rejected. See attached General Terms and Conditions, and Sealed Bid Solicitation for details.

The undersigned offers and agrees to furnish within the time specified, the articles and services at the price stated opposite the respective items listed on the schedule provided, unless otherwise specified by the bidder. In consideration to the expense of the Government in opening, tabulating, and evaluating this and other bids, and other considerations, the undersigned agrees that this bid remain firm and irrevocable within **90** calendar days from the date opening to supply any or all the items which prices are quoted.

NAME AND ADDRESS OF BIDDER:

SIGNATURE AND TITLE OF PERSON  
AUTHORIZED TO SIGN THIS BID:

\_\_\_\_\_  
\_\_\_\_\_  
\_\_\_\_\_

\_\_\_\_\_

AWARD: CONTRACT NO.: \_\_\_\_\_ AMOUNT: \_\_\_\_\_ DATE: \_\_\_\_\_

ITEM NO(S). AWARDED: \_\_\_\_\_

CONTRACTING OFFICER:

\_\_\_\_\_  
RORY J. RESPICIO  
GENERAL MANAGER

NAME AND ADDRESS OF CONTRACTOR:

SIGNATURE AND TITLE OF PERSON  
AUTHORIZED TO SIGN THIS CONTRACT:

\_\_\_\_\_  
\_\_\_\_\_

\_\_\_\_\_

## **SPECIAL PROVISIONS**

### **Contract Period:**

The term of this contract will continue until the expiration of the grant funds under MARAD FY2022 American Marine Highway (AMH) Grant No.: 693JF72340007 and may be extended if the period of performance for the grant funds is extended in accordance with the federal award terms and conditions. The current expiration date of the grant funds is May 1, 2026.

The initial purchase of one (1) 180' Telescopic Boom Lift is funded by MARAD FY2022 American Marine Highway (AMH) Grant No. 693JF72340007

Contract incorporates all applicable provision of the Port Authority of Guam Federal Contract Supplement, and is attached as Exhibit A on pages 54-68 of this IFB.

**GOVERNMENT OF GUAM**

THE PORT AUTHORITY OF GUAM  
1026 Cabras Highway, Suite 201  
Piti, Guam 96915

**BID BOND**

NO. \_\_\_\_\_

KNOW ALL MEN BY THESE PRESENTS that \_\_\_\_\_, as Principal hereinafter called the Principal, and (Bonding Company), \_\_\_\_\_ A duly admitted insurer under the laws of the Territory of Guam, as Surety, hereinafter called the Surety are Held firmly bound unto the Territory of Guam for the sum of \_\_\_\_\_ Dollars (\$ \_\_\_\_\_), for Payment of which sum will and truly to be made, the said Principal and the said Surety bind ourselves, our heirs, executors, administrators, successors and assigns, jointly and severally, firmly by these presents.

WHEREAS, the Principal has submitted a bid for (identify project by number and brief description)

\_\_\_\_\_

NOW, THEREFORE, if the Territory of Guam shall accept the bid of the Principal and the Principal shall enter into a Contract with the Territory of Guam in accordance with the terms of such bid, and give such bond or bonds as may be specified in bidding or Contract Documents with good and sufficient surety for the faithful performance of such Contract and for the prompt payment of labor and material furnished in the prosecution thereof, or in the event of the failure of the Principal to enter such Contract and give such bond or bonds, if the Principal shall pay to the Territory of Guam the difference not to exceed the penalty hereof between the amounts specified in said bid and such larger amount for which the Territory of Guam may in good faith contract with another party to perform work covered by said bid or an appropriate liquidated amount as specified in the Invitation for Bids then this obligation shall be null and void, otherwise to remain full force and effect.

Signed and sealed this \_\_\_\_\_ day of \_\_\_\_\_ 2024

\_\_\_\_\_  
(PRINCIPAL)

\_\_\_\_\_  
(SEAL)

\_\_\_\_\_  
(WITNESS)

\_\_\_\_\_  
(TITLE)

\_\_\_\_\_  
(MAJOR OFFICER OF SURETY)

\_\_\_\_\_  
(MAJOR OFFICER OF SURETY)

\_\_\_\_\_  
(TITLE)

\_\_\_\_\_  
(TITLE)

\_\_\_\_\_  
(RESIDENT GENERAL AGENT)



**INSTRUCTION TO PROVIDERS:**

NOTICE to all Insurance and Bonding Institutions:

The Bond requires the signatures of the Vendor, two (2) major Officers of the Surety and Resident General Agent, if the Surety is a foreign or alien surety.

When the form is submitted to THE PORT AUTHORITY OF GUAM, it should be accompanied with copies of

The following:

1. Current Certificate of Authority to do business on Guam issued by the Department of Revenue and Taxation.
2. Power of Attorney issued by the Surety to the Resident General Agent.
3. Power of Attorney issued by two (2) major officers of the Surety to whoever is signing on their behalf.

Bonds, submitted as Bid Guarantee, without signatures and supporting documents are invalid and Bids will be rejected.

**DECLARATION RE: ETHICAL STANDARDS**  
**(AG Form 005)**

\_\_\_\_\_ [state name of declarant signing below], hereby declares that:

The declarant is \_\_\_\_\_ [state one of the following: the Bidder/Offeror, a partner of the Bidder/Offeror, an officer of the Bidder/Offeror] making the foregoing identified bid or proposal. To the best of declarant's knowledge, neither declarant nor any officers, representatives, agents, subcontractors or employees of bidder/offeror have knowingly influenced any government of Guam employee to breach any of the ethical standards set forth in 5 GCA Chapter 5, Article 11. Further, declarant promises that neither he or she, nor any officer, representative, agent, subcontractor, or employee of bidder/offeror will knowingly influence any government of Guam employee to breach any ethical standards set forth in 5 GCA Chapter 5, Article 11. These statements are made pursuant to 5GCA §§ 5626, 5628 through 5633; and 2 GAR Division 4 § 11103(b).

I hereby declare under penalty of perjury under the laws of Guam that the foregoing is true and correct.

\_\_\_\_\_  
Signature of one of the following:  
Bidder/ Offeror, if the bidder/offeror is an individual; Partner, if the bidder/offeror is a partnership; Officer, if the bidder/offeror is a corporation.

**DECLARATION RE: NO GRATUITIES or KICKBACKS**

(AG Form 004)

\_\_\_\_\_ [state name of declarant signing below], hereby  
declare that:

1. The name of the offering firm or individual is \_\_\_\_\_ [state name of bidder/offeror company] Declarant is \_\_\_\_\_ [state one of the following: the bidder/offeror, a partner of the bidder/offeror, an officer of the bidder/offeror] making the foregoing identified bid or proposal.

2. To the best of declarant's knowledge, neither declarant, nor any of the bidder's/offeror's officers, representatives, agents, subcontractors, or employees have violated, are violating the prohibition against gratuities and kickbacks set forth in 2 GAR Division 4 § 11107(e). Further, affiant promises, on behalf of bidder/offeror, not to violate the prohibition against gratuities and kickbacks as set forth in 2 GAR Division 4 § 11107(e).

3. To the best of declarant's knowledge, neither declarant, nor any of the bidders/offerors officers, representatives, agents, subcontractors, or employees have offered, given or agreed to give, any government of Guam employee or former government employee, any payment, gift, kickback, gratuity or offer of employment in connection with the bidders/offerors bid or proposal.

4. I make these statements on behalf of myself as a representative of the bidder/offeror, and on behalf of the bidder/offeror's officers, representatives, agents, subcontractors, and employees.

I hereby declare under penalty of perjury under the laws of Guam that the foregoing is true and correct.

\_\_\_\_\_  
Signature of one of the following:

Offeror, if the bidder/offeror is an individual;  
Partner, if the bidder/offeror is a partnership;  
Officer, if the bidder/offeror is a corporation.

**SPECIAL PROVISIONS**

**RESTRICTION AGAINST SEX OFFENDERS EMPLOYED BY SERVICES PROVIDERS TO GOVERNMENT OF GUAM FROM WORKING ON GOVERNMENT PROPERTY**

If a contract for services is awarded to the bidder or offeror, then the service provider must warranty that no person in its employment who has been convicted of a sex offense under the provisions of chapter 25 of Title 9 of Guam code Annotated or of an offense defined in Article 2 of chapter 28 of Title 9 of the Guam Code annotated, or who has been convicted in any other jurisdiction of an offense with the same elements as heretofore defined, or who is listed on the Sex Offender Registry, shall provide services on behalf of the service provider while on government of Guam property, with the exception of public highways. If any employee of a service provider is providing services on government property and is convicted subsequent to an award of a contract, then the service provider warrants that it will notify the Government of the conviction within twenty-four (24) hours of the conviction, and will immediately remove such convicted person from providing services on government property. If the service provider is found to be in violation of any of the provisions of this paragraph, then the government will give notice to the service provider to take corrective action. The service provider shall take corrective action within twenty-four (24) hours of notice from the Government, and the service provider shall notify the Government when action has been taken. If the service providers fail to take corrective steps within twenty-four (24) hours of notice from the Government, then the Government in its sole discretion may suspend temporarily and contract for services until corrective action has been taken.

_____ Signature of Bidder	_____ Date
Proposer, if an individual; Partner, if a partnership; Officer, if a corporation.	

**DECLARATION RE COMPLIANCE WITH U.S. D.O.L. WAGE DETERMINATION**

Procurement No: IFB PAG-004-24 **180' Telescopic Boom Lift**

Name of Offeror Company: \_\_\_\_\_ hereby certifies under penalty of perjury:

(1) That I am \_\_\_\_\_ (the offeror, a partner of the offeror, an officer of the offeror) making the bid or proposal in the foregoing identified procurement;

(2) That I have read and understand the provisions of 5 GCA § 5801 and § 5802 which read:

**§ 5801. Wage Determination Established.**

In such cases where the government of Guam enters into contractual arrangements with a sole proprietorship, a partnership or a corporation (“contractor”) for the provision of a service to the government of Guam, and in such cases where the contractor employs a person(s) whose purpose, in whole or in part, is the direct delivery of service contracted by the government of Guam, then the contractor shall pay such employee(s) in accordance with the Wage Determination for Guam and the Northern Mariana Islands issued and promulgated by the U.S. Department of Labor for such labor as is employed in the direct delivery of contract deliverables to the government of Guam.

The Wage Determination most recently issued by the U.S. Department of Labor at the time a contract is awarded to a contractor by the government of Guam shall be used to determine wages, which shall be paid to employees pursuant to this Article. Should any contract contain a renewal clause, then at the time of renewal adjustments, there shall be made stipulations contained in that contract for applying the Wage Determination, as required by this Article, so that the Wage Determination promulgated by the U.S. Department of Labor on a date most recent to the renewal date shall apply.

**§ 5802. Benefits.**

In addition to the Wage Determination detailed in this Article, any contract to which this Article applies shall also contain provisions mandating health and similar benefits for employees covered by this Article, such benefits having a minimum value as detailed in the Wage Determination issued and promulgated by the U.S. Department of Labor, and shall contain provisions guaranteeing a minimum of ten (10) paid holidays per annum per employee.

(3) That the offeror is in full compliance with 5 GCA § 5801 and § 5802, as may be applicable to the procurement referenced herein;

(4) That I have attached the most recent wage determination applicable to Guam issued by the U.S. Department of Labor. [INSTRUCTIONS – Please attach]

\_\_\_\_\_  
Signature Date

**"REGISTER OF WAGE DETERMINATIONS  
UNDER THE SERVICE CONTRACT ACT  
By direction of the Secretary of Labor**

Daniel W. Simms, Division of  
Director Wage Determinations

**U.S. DEPARTMENT OF LABOR  
EMPLOYMENT STANDARDS ADMINISTRATION  
WAGE AND HOUR DIVISION  
WASHINGTON D.C. 20210**

Wage Determination No.: 2015-5693  
Revision No.: 19 | Date of Last Revision: 07/17/2023

Note: Contracts subject to the Service Contract Act are generally required to pay at least the applicable minimum wage rate required under Executive Order 14026. If the contract is entered into on or after January 30 2022 or the contract is renewed or extended (e.g., an option is exercised) on or after January 30 2022: The contractor must pay all covered workers at least \$16.20 per hour (or the applicable wage rate listed on this wage determination if it is higher) for all hours spent performing on the contract in 2023.

The applicable Executive Order minimum wage rate will be adjusted annually. Additional information on contractor requirements and worker protections under the Executive Orders is available at <https://www.dol.gov/agencies/whd/government-contracts>.

States: Guam Northern Marianas Wake Island  
Area: Guam Statewide  
Northern Marianas Statewide  
Wake Island Statewide

**\*\*Fringe Benefits Required Follow the Occupational Listing\*\***

OCCUPATION CODE - TITLE	FOOTNOTE RATE	OCCUPATION CODE - TITLE	FOOTNOTE RATE
-------------------------	---------------	-------------------------	---------------

01000 - Administrative Support And Clerical Occupations		09000 - Furniture Maintenance And Repair Occupations
01011 - Accounting Clerk I	14.27***	09010 - Electrostatic Spray Painter
01012 - Accounting Clerk II	16.02***	18.75
01013 - Accounting Clerk III	17.93	09040 - Furniture Handler
01020 - Administrative Assistant	21.43	11.37***
01035 - Court Reporter	17.40	09080 - Furniture Refinisher
01041 - Customer Service Representative I	12.75***	18.75
01042 - Customer Service Representative II	14.23***	09090 - Furniture Refinisher Helper
01043 - Customer Service Representative III	15.62***	13.77***
01051 - Data Entry Operator I	12.16***	09110 - Furniture Repairer, Mi
01052 - Data Entry Operator II	13.27***	16.32
01060 - Dispatcher, Motor Vehicle	17.39	09130 - Upholsterer
01070 - Document Preparation Clerk	13.85***	18.75
01090 - Duplicating Machine Operator	13.85***	11000 - General Services And Support Occupations
01111 - General Clerk I	11.33***	11030 - Cleaner, Vehicles
01112 - General Clerk II	12.36***	9.69***
01113 - General Clerk III	13.88***	11060 - Elevator Operator
01120 - Housing Referral Assistant	19.39	9.69***
01141 - Messenger Courier	11.37***	11090 - Gardener
01191 - Order Clerk I	12.57***	14.28***
01192 - Order Clerk II	13.71***	11122 - Housekeeping Aide
01261 - Personnel Assistant (Employment) I	15.95***	10.13***
01262 - Personnel Assistant (Employment) II	17.85	11150 - Janitor
01263 - Personnel Assistant (Employment) III	19.89	10.13***
01270 - Production Control Clerk	22.97	11210 - Laborer, Grounds Maintenance
01290 - Rental Clerk	11.10***	10.79***
01300 - Scheduler, Maintenance	15.55***	11240 - Maid or Houseman
01311 - Secretary I	15.55***	9.67***
01312 - Secretary II	17.40	11260 - Pruner
01313 - Secretary III	19.39	9.66***
01320 - Service Order Dispatcher	15.40***	11270 - Tractor Operator
01410 - Supply Technician	21.43	13.07***
01420 - Survey Worker	16.96	11330 - Trail Maintenance Worker
01460 - Switchboard Operator/Receptionist	10.78***	10.79***
01531 - Travel Clerk I	13.01***	01612 - Word Processor II
01532 - Travel Clerk II	14.12***	16.31
01533 - Travel Clerk III	15.09***	11360 - Window Cleaner
01611 - Word Processor I	14.53***	11.32***
		12000 - Health Occupations
01613 - Word Processor III	18.26	12010 - Ambulance Driver
05000 - Automotive Service Occupations		18.96
05005 - Automobile Body Repairer, Fiberglass	17.20	12011 - Breath Alcohol Technician
05010 - Automotive Electrician	16.16***	18.96
05040 - Automotive Glass Installer	15.11***	12012 - Certified Occupational Therapist Assistant
05070 - Automotive Worker	15.11***	26.02
05110 - Mobile Equipment Servicer	12.96***	12015 - Certified Physical Therapist Assistant
05130 - Motor Equipment Metal Mechanic	17.20	26.02
05160 - Motor Equipment Metal Worker	15.11***	12020 - Dental Assistant
05190 - Motor Vehicle Mechanic	17.20	18.79
05220 - Motor Vehicle Mechanic Helper	11.87***	12025 - Dental Hygienist
05250 - Motor Vehicle Upholstery Worker	14.06***	39.73
05280 - Motor Vehicle Wrecker	15.11***	12030 - EKG Technician
05310 - Painter, Automotive	16.16***	28.73
05340 - Radiator Repair Specialist	15.11***	12035 - Electroneurodiagnostic Technologist
05370 - Tire Repairer	12.67***	28.73
05400 - Transmission Repair Specialist	17.20	12040 - Emergency Medical Technician
07000 - Food Preparation And Service Occupations		18.96
07010 - Baker	11.10***	12071 - Licensed Practical Nurse I
07041 - Cook I	14.44***	16.95
07042 - Cook II	16.84	12072 - Licensed Practical Nurse II
07070 - Dishwasher	9.69***	18.96
07130 - Food Service Worker	10.11***	12073 - Licensed Practical Nurse III
07210 - Meat Cutter	13.34***	21.14
07260 - Waiter/Waitress	9.73***	12100 - Medical Assistant
		13.42***
		12130 - Medical Laboratory Technician
		18.82
		12160 - Medical Record Clerk
		14.97***
		12190 - Medical Record Technician
		17.77
		12195 - Medical Transcriptionist
		16.95
		12210 - Nuclear Medicine Technologist
		41.68
		12221 - Nursing Assistant I
		12.43***
		12222 - Nursing Assistant II
		13.97***
		12223 - Nursing Assistant III
		15.24***
		12224 - Nursing Assistant IV
		17.12
		12235 - Optical Dispenser
		18.96
		12236 - Optical Technician
		16.95
		12250 - Pharmacy Technician
		15.49***
		12280 - Phlebotomist
		16.95
		12305 - Radiologic Technologist
		28.73
		12311 - Registered Nurse I
		23.50
		12312 - Registered Nurse II
		28.73
		12313 - Registered Nurse II, Specialist
		28.73
		12314 - Registered Nurse III
		34.76
		12315 - Registered Nurse III, Anesthetist
		34.76
		12316 - Registered Nurse IV
		41.68
		12317 - Scheduler (Drug and Alcohol Testing)
		23.50
		12320 - Substance Abuse Treatment Counselor
		23.50
		13000 - Information And Arts Occupations
		13011 - Exhibits Specialist I
		21.42
		13012 - Exhibits Specialist II
		26.53
		13013 - Exhibits Specialist III
		32.45
		13041 - Illustrator I
		21.42
		13042 - Illustrator II
		26.53
		13043 - Illustrator III
		32.45

OCCUPATION CODE - TITLE	FOOTNOTE RATE	FOOTNOTE
13047 - Librarian	29.38	
13050 - Library Aide/Clerk	17.05	
13054 - Library Information Technology Systems Administrator	26.53	
13058 - Library Technician	18.11	
13061 - Media Specialist I	19.15	
13062 - Media Specialist II	21.42	
13063 - Media Specialist III	23.87	
13071 - Photographer I	19.15	
13072 - Photographer II	21.42	
13073 - Photographer III	26.53	
13074 - Photographer IV	32.45	
13075 - Photographer V	39.27	
13090 - Technical Order Library Clerk	21.42	
13110 - Video Teleconference Technician	19.15	
14000 - Information Technology Occupations		
14041 - Computer Operator I	15.71***	
14042 - Computer Operator II	17.22	
14043 - Computer Operator III	19.19	
14044 - Computer Operator IV	21.33	
14045 - Computer Operator V	23.62	
14071 - Computer Programmer I	(see 1) 15.73***	
14072 - Computer Programmer II	(see 1) 19.50	
14073 - Computer Programmer III	(see 1) 23.84	
14074 - Computer Programmer IV	(see 1)	
14101 - Computer Systems Analyst I	(see 1) 24.23	
14102 - Computer Systems Analyst II	(see 1)	
14103 - Computer Systems Analyst III	(see 1)	
14150 - Peripheral Equipment Operator	15.71***	
14160 - Personal Computer Support Technician	21.33	
14170 - System Support Specialist	21.24	
15000 - Instructional Occupations		
15010 - Aircrew Training Devices Instructor (Non-Rated)	24.23	
15020 - Aircrew Training Devices Instructor (Rated)	29.32	
15030 - Air Crew Training Devices Instructor (Pilot)	34.91	
15050 - Computer Based Training Specialist / Instructor	24.23	
15060 - Educational Technologist	29.40	
15070 - Flight Instructor (Pilot)	34.91	
15080 - Graphic Artist	20.47	
15085 - Maintenance Test Pilot, Fixed, Jet/Prop	34.91	
15086 - Maintenance Test Pilot, Rotary Wing	34.91	
15088 - Non-Maintenance Test/Co-Pilot	34.91	
15090 - Technical Instructor	17.67	
15095 - Technical Instructor/Course Developer	23.78	
15110 - Test Proctor	15.70***	
15120 - Tutor	15.70***	
16000 - Laundry, Dry-Cleaning, Pressing And Related Occupations		
16010 - Assembler	10.83***	
16030 - Counter Attendant	10.83***	
16040 - Dry Cleaner	12.36***	
16070 - Finisher, Flatwork, Machine	10.83***	
16090 - Presser, Hand	10.83***	
16110 - Presser, Machine, Drycleaning	10.83***	
16130 - Presser, Machine, Shirts	10.83***	
16160 - Presser, Machine, Wearing Apparel, Laundry	10.83***	
16190 - Sewing Machine Operator	12.88***	
16220 - Tailor	13.40***	
16250 - Washer, Machine	11.34***	
19000 - Machine Tool Operation And Repair Occupations		
19010 - Machine-Tool Operator (Tool Room)	19.46	
19040 - Tool And Die Maker	24.46	
21000 - Materials Handling And Packing Occupations		
21020 - Forklift Operator	15.36***	
21030 - Material Coordinator	22.97	
21040 - Material Expediter	22.97	
21050 - Material Handling Laborer	12.57***	
21071 - Order Filler	10.62***	
21080 - Production Line Worker (Food Processing)	15.36***	
21110 - Shipping Packer	17.12	
21130 - Shipping/Receiving Clerk	17.12	
21140 - Store Worker I	15.83***	
21150 - Stock Clerk	22.26	
21210 - Tools And Parts Attendant	15.36***	
21410 - Warehouse Specialist	15.36***	
23000 - Mechanics And Maintenance And Repair Occupations		
23010 - Aerospace Structural Welder	25.04	
23019 - Aircraft Logs and Records Technician	19.47	
23021 - Aircraft Mechanic I	23.84	
23022 - Aircraft Mechanic II	25.04	
23023 - Aircraft Mechanic III	26.30	
23040 - Aircraft Mechanic Helper	16.58	
23050 - Aircraft, Painter	22.39	
23060 - Aircraft Servicer	19.47	
23070 - Aircraft Survival Flight Equipment Technician	22.39	
23080 - Aircraft Worker	21.03	
23091 - Aircrew Life Support Equipment (ALSE) Mechanic I	21.03	
23092 - Aircrew Life Support Equipment (ALSE) Mechanic II	23.84	

OCCUPATION CODE - TITLE	FOOTNOTE RATE	RAT
23110 - Appliance Mechanic	19.46	
23120 - Bicycle Repairer	15.61***	
23125 - Cable Splicer	22.47	
23130 - Carpenter, Maintenance	17.58	
23140 - Carpet Layer	18.20	
23160 - Electrician, Maintenance	19.37	
23181 - Electronics Technician Maintenance I	18.20	
23182 - Electronics Technician Maintenance II	19.46	
23183 - Electronics Technician Maintenance III	20.72	
23260 - Fabric Worker	16.94	
23290 - Fire Alarm System Mechanic	16.77	
23310 - Fire Extinguisher Repairer	15.61***	
23311 - Fuel Distribution System Mechanic	20.72	
23312 - Fuel Distribution System Operator	15.61***	
23370 - General Maintenance Worker	13.24***	
23380 - Ground Support Equipment Mechanic	23.84	
23381 - Ground Support Equipment Servicer	19.47	
23382 - Ground Support Equipment Worker	21.03	
23391 - Gunsmith I	15.61***	
23392 - Gunsmith II	18.20	
23393 - Gunsmith III	20.72	
23410 - Heating, Ventilation And Air-Conditioning Mechanic	19.27	
23411 - Heating, Ventilation And Air Conditioning Mechanic (Research Facility)	20.50	
23430 - Heavy Equipment Mechanic	19.50	
23440 - Heavy Equipment Operator	18.10	
23460 - Instrument Mechanic	20.72	
23465 - Laboratory/Shelter Mechanic	19.46	
23470 - Laborer	12.57***	
23510 - Locksmith	19.46	
23530 - Machinery Maintenance Mechanic	23.13	
23550 - Machinist, Maintenance	20.72	
23580 - Maintenance Trades Helper	11.77***	
23591 - Metrology Technician I	20.72	
23592 - Metrology Technician II	22.03	
23593 - Metrology Technician III	23.33	
23640 - Millwright	20.72	
23710 - Office Appliance Repairer	19.46	
23760 - Painter, Maintenance	17.04	
23790 - Pipefitter, Maintenance	19.96	
23810 - Plumber, Maintenance	18.75	
23820 - Pneudraulic Systems Mechanic	20.72	
23850 - Rigger	20.72	
23870 - Scale Mechanic	18.20	
23890 - Sheet-Metal Worker, Maintenance	19.55	
23910 - Small Engine Mechanic	18.20	
23931 - Telecommunications Mechanic I	19.96	
23932 - Telecommunications Mechanic II	21.24	
23950 - Telephone Lineman	20.62	
23960 - Welder, Combination, Maintenance	19.96	
23965 - Well Driller	21.13	
23970 - Woodcraft Worker	20.71	
23980 - Woodworker	15.61***	
24000 - Personal Needs Occupations		
24550 - Case Manager	15.01***	
24570 - Child Care Attendant	10.09***	
24580 - Child Care Center Clerk	13.25***	
24610 - Chore Aide	14.06***	
24620 - Family Readiness And Support Services Coordinator	15.01***	
24630 - Homemaker	16.12***	
25000 - Plant And System Operations Occupations		
25010 - Boiler Tender	22.79	
25040 - Sewage Plant Operator	22.89	
25070 - Stationary Engineer	22.79	
25190 - Ventilation Equipment Tender	15.72***	
25210 - Water Treatment Plant Operator	22.89	
27000 - Protective Service Occupations		
27004 - Alarm Monitor	10.90***	
27007 - Baggage Inspector	9.63***	
27008 - Corrections Officer	14.59***	
27010 - Court Security Officer	14.59***	
27030 - Detection Dog Handler	10.90***	
27040 - Detention Officer	14.59***	
27070 - Firefighter	14.59***	
27101 - Guard I	9.63***	
27102 - Guard II	10.90***	
27131 - Police Officer I	14.59***	
27132 - Police Officer II	16.21	
28000 - Recreation Occupations		
28041 - Carnival Equipment Operator	13.24***	
28042 - Carnival Equipment Repairer	14.46***	
28043 - Carnival Worker	9.78***	
28210 - Gate Attendant/Gate Tender	13.18***	

OCCUPATION CODE - TITLE FOOTNOTE RATE

OCCUPATION CODE - TITLE FOOTNOTE RATE



28310 - Lifeguard	11.01***		99000 - Miscellaneous Occupations	
28350 - Park Attendant (Aide)	14.74***		99020 - Cabin Safety Specialist	16.14***
28510 - Recreation Aide/Health Facility Attendant	11.84***		99030 - Cashier	10.01***
28515 - Recreation Specialist	18.26		99050 - Desk Clerk	9.71***
29000 - Stevedoring/Longshorem Occupational Services			99095 - Embalmer	27.37
29010 - Blocker And Bracer	26.02		99130 - Flight Follower	27.37
29020 - Hatch Tender	26.02		99251 - Laboratory Animal Caretaker I	24.31
29030 - Line Handler	26.02		99252 - Laboratory Animal Caretaker II	26.56
29041 - Stevedore I	24.21		99260 - Marketing Analyst	21.54
29042 - Stevedore II	27.82		99310 - Mortician	27.37
30000 - Technical Occupations			99410 - Pest Controller	16.07***
30010 - Air Traffic Control Specialist, Center (HFO) (see 2)	43.06		99510 - Photofinishing Worker	14.38***
30011 - Air Traffic Control Specialist, Station (HFO) (see 2)	29.69		99710 - Recycling Laborer	17.32
30012 - Air Traffic Control Specialist, Terminal (HFO) (see 2)	32.70		99711 - Recycling Specialist	23.38
30021 - Archeological Technician I	18.17		99730 - Refuse Collector	16.40
30022 - Archeological Technician II	20.33		99810 - Sales Clerk	10.63***
30023 - Archeological Technician III	25.19		99820 - School Crossing Guard	17.96
30030 - Cartographic Technician	25.19		99830 - Survey Party Chief	23.99
30040 - Civil Engineering Technician	25.19		99831 - Surveying Aide	13.65***
30051 - Cryogenic Technician I	27.89		99832 - Surveying Technician	17.73
30052 - Cryogenic Technician II	30.80		99840 - Vending Machine Attendant	24.31
30061 - Drafter/CAD Operator I	18.17		99841 - Vending Machine Repairer	30.96
30062 - Drafter/CAD Operator II	20.33			
30063 - Drafter/CAD Operator III	22.66			
30064 - Drafter/CAD Operator IV	27.89			
30081 - Engineering Technician I	16.19***			
30082 - Engineering Technician II	18.17			
30083 - Engineering Technician III	20.33			
30084 - Engineering Technician IV	25.19			
30085 - Engineering Technician V	30.80			
30086 - Engineering Technician VI	37.27			
30090 - Environmental Technician	25.19			
30095 - Evidence Control Specialist	25.19			
30210 - Laboratory Technician	22.66			
30221 - Latent Fingerprint Technician I	27.89			
30222 - Latent Fingerprint Technician II	30.80			
30240 - Mathematical Technician	25.19			
30361 - Paralegal/Legal Assistant I	19.54			
30362 - Paralegal/Legal Assistant II	24.21			
30363 - Paralegal/Legal Assistant III	29.61			
30364 - Paralegal/Legal Assistant IV	35.83			
30375 - Petroleum Supply Specialist	30.80			
30390 - Photo-Optics Technician	24.92			
30395 - Radiation Control Technician	30.80			
30461 - Technical Writer I	25.19			
30462 - Technical Writer II	30.80			
30463 - Technical Writer III	37.27			
30491 - Unexploded Ordnance (UXO) Technician I	27.37			
30492 - Unexploded Ordnance (UXO) Technician II	33.11			
30493 - Unexploded Ordnance (UXO) Technician III	39.69			
30494 - Unexploded (UXO) Safety Escort	27.37			
30495 - Unexploded (UXO) Sweep Personnel	27.37			
30501 - Weather Forecaster I	27.89			
30502 - Weather Forecaster II	33.93			
30620 - Weather Observer, Combined Upper Air Or	(see 2) 22.66			
Surface Programs				
30621 - Weather Observer, Senior (see 2)	25.19			
31000 - Transportation/Mobile Equipment Operation Occupations				
31010 - Airplane Pilot	33.11			
31020 - Bus Aide	8.97***			
31030 - Bus Driver	11.73***			
31043 - Driver Courier	10.26***			
31260 - Parking and Lot Attendant	9.91***			
31290 - Shuttle Bus Driver	11.65***			
31310 - Taxi Driver	11.41***			
31361 - Truckdriver, Light	11.21***			
31362 - Truckdriver, Medium	12.16***			
31363 - Truckdriver, Heavy	16.11***			
31364 - Truckdriver, Tractor-Trailer	16.11***			

\*\*\*Workers in this classification may be entitled to a higher minimum wage under Executive Order 14026 (\$16.20 per hour). Please see the Note at the top of the wage determination for more information. Please also note that the minimum wage requirements of Executive Order 14026 are not currently being enforced as to contracts or contract-like instruments entered into with the federal government in connection with seasonal recreational services or seasonal recreational equipment rental for the general public on federal lands.

ALL OCCUPATIONS LISTED ABOVE RECEIVE THE FOLLOWING BENEFITS:

HEALTH & WELFARE: \$4.98 per hour, up to 40 hours per week, or \$199.20 per week or \$863.20 per month

HEALTH & WELFARE EO 13706: \$4.57 per hour, up to 40 hours per week, or \$182.80 per week, or \$792.13 per month\*

\*This rate is to be used only when compensating employees for performance on an SCA-covered contract also covered by EO 13706, Establishing Paid Sick Leave for Federal Contractors. A contractor may not receive credit toward its SCA obligations for any paid sick leave provided pursuant to EO 13706.

VACATION: 2 weeks paid vacation after 1 year of service with a contractor or successor; and 4 weeks after 3 years. Length of service includes the whole span of continuous service with the present contractor or successor, wherever employed, and with the predecessor contractors in the performance of similar work at the same Federal facility. (Reg. 29 CFR 4.173) HOLIDAYS: A minimum of eleven paid holidays per year: New Year's Day, Martin Luther King Jr.'s Birthday, Washington's Birthday, Memorial Day, Juneteenth National Independence Day, Independence Day, Labor Day, Columbus Day, Veterans' Day, Thanksgiving Day, and Christmas Day. (A contractor may substitute for any of the named holidays another day off with pay in accordance with a plan communicated to the employees involved.) (See 29 CFR 4.174)

THE OCCUPATIONS WHICH HAVE NUMBERED FOOTNOTES IN PARENTHESES RECEIVE THE FOLLOWING:

1) **COMPUTER EMPLOYEES:** This wage determination does not apply to any individual employed in a bona fide executive, administrative, or professional capacity, as defined in 29 C.F.R. Part 541. (See 41 C.F.R. 6701(3)). Because most Computer Systems Analysts and Computer Programmers who are paid at least \$27.63 per hour (or at least \$684 per week if paid on a salary or fee basis) likely qualify as exempt computer professionals under 29 U.S.C. 213(a)(1) and 29 U.S.C. 213(a)(17), this wage determination may not include wage rates for all occupations within those job families. In such instances, a conformance will be necessary if there are nonexempt employees in these job families working on the contract.

Job titles vary widely and change quickly in the computer industry, and are not determinative of whether an employee is an exempt computer professional. To be exempt, computer employees who satisfy the compensation requirements must also have a primary duty that consists of:

(1) The application of systems analysis techniques and procedures, including consulting with users, to determine hardware, software or system functional specifications;

(2) The design, development, documentation, analysis, creation, testing or modification of computer systems or programs, including prototypes, based on and related to user or system design specifications;

(3) The design, documentation, testing, creation or modification of computer programs related to machine operating systems; or

(4) A combination of the aforementioned duties, the performance of which requires the same level of skills. (29 C.F.R. 541.400).

Any computer employee who meets the applicable compensation requirements and the above duties test qualifies as an exempt computer professional under both section 13(a)(1) and section 13(a)(17) of the Fair Labor Standards Act. (Field Assistance Bulletin No. 2006-3 (Dec. 14, 2006)). Accordingly, this wage determination will not apply to any exempt computer employee regardless of which of these two exemptions is utilized.

2) **AIR TRAFFIC CONTROLLERS AND WEATHER OBSERVERS - NIGHT PAY & SUNDAY PAY:** If you work at night as part of a regular tour of duty, you will earn a night differential and receive an additional 10% of basic pay for any hours worked between 6pm and 6am. If you are a full-time employed (40 hours a week) and Sunday is part of your regularly scheduled workweek, you are paid at your rate of basic pay plus a Sunday premium of 25% of your basic rate for each hour of Sunday work which is not overtime (i.e.: occasional work on Sunday outside the normal tour of duty is considered overtime work).

**\*\* HAZARDOUS PAY DIFFERENTIAL \*\***

An 8 percent differential is applicable to employees employed in a position that represents a high degree of hazard when working with or in close proximity to ordnance, explosives, and incendiary materials. This includes work such as screening, blending, dying, mixing, and pressing of sensitive ordnance, explosives, and pyrotechnic compositions such as lead azide, black powder and photoflash powder. All dry-house activities involving propellants or explosives. Demilitarization, modification, renovation, demolition, and maintenance operations on sensitive ordnance, explosives and incendiary materials. All operations involving re-grading and cleaning of artillery ranges.

A 4 percent differential is applicable to employees employed in a position that represents a low degree of hazard when working with, or in close proximity to ordnance, (or employees possibly adjacent to) explosives and incendiary materials which involves potential injury such as laceration of hands, face, or arms of the employee engaged in the operation, irritation of the skin, minor burns and the like; minimal damage to immediate or adjacent work area or equipment being used. All operations involving, unloading, storage, and hauling of ordnance, explosive, and incendiary ordnance material other than small arms ammunition. These differentials are only applicable to work that has been specifically designated by the agency for ordnance, explosives, and incendiary material differential pay.

**\*\* UNIFORM ALLOWANCE \*\***

If employees are required to wear uniforms in the performance of this contract (either by the terms of the Government contract, by the employer, by the state or local law, etc.), the cost of furnishing such uniforms and maintaining (by laundering or dry cleaning) such uniforms is an expense that may not be borne by an employee where such cost reduces the hourly rate below that required by the wage determination. The Department of Labor will accept payment in accordance with the following standards as compliance:

The contractor or subcontractor is required to furnish all employees with an adequate number of uniforms without cost or to reimburse employees for the actual cost of the uniforms. In addition, where uniform cleaning and maintenance is made the responsibility of the employee, all contractors and subcontractors subject to this wage determination shall (in the absence of a bona fide collective bargaining agreement providing for a different amount, or the furnishing of contrary affirmative proof as to the actual cost), reimburse all employees for such cleaning and maintenance at a rate of \$3.35 per week (or \$.67 cents per day). However, in those instances where the uniforms furnished are made of "wash and wear" materials, may be routinely washed and dried with other personal garments, and do not require any special treatment such as dry cleaning, daily washing, or commercial laundering in order to meet the cleanliness or appearance standards set by the terms of the Government contract, by the contractor, by law, or by the nature of the work, there is no requirement that employees be reimbursed for uniform maintenance costs.

**\*\* SERVICE CONTRACT ACT DIRECTORY OF OCCUPATIONS \*\***

The duties of employees under job titles listed are those described in the "Service Contract Act Directory of Occupations", Fifth Edition (Revision 1), dated September 2015, unless otherwise indicated.

**\*\* REQUEST FOR AUTHORIZATION OF ADDITIONAL CLASSIFICATION AND WAGE RATE, Standard Form 1444 (SF-1444) \*\***

Conformance Process: The contracting officer shall require that any class of service employee which is not listed herein and which is to be employed under the contract (i.e., the work to be performed is not performed by any classification listed in the wage determination), be classified by the contractor so as to provide a reasonable relationship (i.e., appropriate level of skill comparison) between such unlisted classifications and the classifications listed in the wage determination (See 29 CFR 4.6(b)(2)(i)). Such conforming procedures shall be initiated by the contractor prior to the performance of contract work by such unlisted class(es) of employees (See 29 CFR 4.6(b)(2)(ii)). The Wage and Hour Division shall make a final determination of conformed classification, wage rate, and/or fringe benefits which shall be paid to all employees performing in the classification from the first day of work on which contract work is performed by them in the classification. Failure to pay such unlisted employees the compensation agreed upon by the interested parties and/or fully determined by the Wage and Hour Division retroactive to the date such class of employees commenced contract work shall be a violation of the Act and this contract. (See 29 CFR 4.6(b)(2)(v)). When multiple wage determinations are included in a contract, a separate SF-1444 should be prepared for each wage determination to which a class(es) is to be confirmed.

The process for preparing a conformance request is as follows:

1) When preparing the bid, the contractor identifies the need for a conformed occupation(s) and computes a proposed rate(s).

2) After contract award, the contractor prepares a written report listing in order the proposed classification title(s), a federal grade equivalency (FGE) for each proposed classification(s), job description(s), and rationale for proposed wage rate(s), including information regarding the agreement or disagreement of the authorized representative of the employees involved, or where there is no authorized representative, the employees themselves. This report should be submitted to the contracting officer no later than 30 days after such unlisted class(es) of employees performs any contract work.

3) The contracting officer reviews the proposed action and promptly submits a report of the action, together with the agency's recommendations and pertinent information including the position of the contractor and the employees, to the U.S. Department of Labor, Wage and Hour Division, for review (See 29 CFR 4.6(b)(2)(ii)).

4) Within 30 days of receipt, the Wage and Hour Division approves, modifies, or disapproves the action via transmittal to the agency contracting officer, or notifies the contracting officer that additional time will be required to process the request.

5) The contracting officer transmits the Wage and Hour Division's decision to the contractor.

6) Each affected employee shall be furnished by the contractor with a written copy of such determination or it shall be posted as a part of the wage determination (See 29 CFR 4.6(b)(2)(iii)).

Information required by the Regulations must be submitted on SF-1444 or bond paper.

When preparing a conformance request, the ""Service Contract Act Directory of Occupations"" should be used to compare job definitions to ensure that duties requested are not performed by a classification already listed in the wage determination. Remember, it is not the job title, but the required tasks that determine whether a class is included in an established wage determination. Conformances may not be used to artificially split, combine, or subdivide classifications listed in the wage determination (See 29 CFR 4.152(c)(1))."

**DECLARATION RE: NON-COLLUSION**  
(AG FORM 003)

\_\_\_\_\_ [state name of declarant signing below], declares that:

1. The name of the bidding/offering company or individual is [state name of company]  
\_\_\_\_\_.

2. The Bid/Proposal for the solicitation identified above is genuine and not collusive or a sham. The bidder/offeror has not colluded, conspired, connived or agreed, directly or indirectly, with any other bidder/offeror or person, to put in a sham bid/proposal or to refrain from making an offer. The bidder/offeror has not in any manner, directly or indirectly, sought by an agreement or collusion, or communication or conference, with any person to fix the proposal price of bidder/offeror or of any other bidder/offeror, or to fix any overhead, profit or cost element of said proposal price, or of that of any other bidder/offeror, or to secure any advantage against the government of Guam or any other bidder/offeror, or to secure any advantage against the government of Guam or any person interested in the proposed contract. All statements in this affidavit and in the proposal are true to the best of the knowledge of the undersigned. This statement is made pursuant to 2 GAR Division 4 § 3126(b).

3. I make this statement on behalf of myself as a representative of the bidder/offeror, and on behalf of the bidder/offeror's officers, representatives, agents, subcontractors, and employees.

I hereby declare under penalty of perjury under the laws of Guam that the foregoing is true and correct.

\_\_\_\_\_  
Signature of one of the following:

Offeror, if the bidder/offeror is an individual;  
Partner, if the bidder/offeror is a partnership;  
Officer, if the bidder/offeror is a corporation.

**DECLARATION DISCLOSING OWNERSHIP, INFLUENCE, COMMISSIONS  
AND CONFLICTS OF INTEREST**

(Required by 5 GCA § 5233 as amended by P.L. 36-13 (4/9/2021))

Preface. As a condition of submitting a Bid/Offer/Proposal or responding to any method of source selection under Guam’s Procurement Law for the purpose of entering into a contract with the government of Guam, this Affidavit requires all Bidders/Offerors/Prospective Contractors to make disclosures of ownership, influence, commissions, gratuities, kickbacks, and conflicts of interest occurring **during the 365 calendar days preceding the publication of this solicitation and until award of a contract**. This includes the duty to disclose **any changes** to the facts disclosed herein throughout the solicitation process; and if the entity submitting this Affidavit is awarded a contract, the duty to disclose **any changes** to the facts disclosed herein **continues throughout the life of the contract, including any extensions or renewals**.

A. I, the undersigned, hereby declare that I am an authorized representative of the Bidder/Offeror/Prospective Contractor and that (please check and fill out all that apply):

The Bidder/Offeror/Prospective Contractor is an individual with a business license, and all decisions are by, and all profit is for, that same individual, with principal place of business street address being:

\_\_\_\_\_

\_\_\_\_\_

The Bidder/Offeror/Prospective Contractor is a business or artificial person (as defined in 1 GCA § 715 or 5 GCA §§ 5030(n) or 5233(b)), and is a sole proprietorship owned entirely (100%) by \_\_\_\_\_, with principal place of business street address being:

\_\_\_\_\_

\_\_\_\_\_

The Bidder/Offeror/Prospective Contractor is a business or artificial person (as defined in 1 GCA § 715 or 5 GCA §§ 5030(n) or 5233(b)), and is owned by the following multiple individuals. Note: owners of more than 10% are statutorily required to be listed below, but other owners of smaller percentage are encouraged to be listed as well.

Name of Owner	Principal Place of Business Street Address	% of Interest
_____	_____	_____
_____	_____	_____
_____	_____	_____
_____	_____	_____

One or more of the more-than-10% owners listed above is a business or artificial person. Any more-than-25% owners of such a business or artificial person are listed below per 5 GCA § 5233. Note: any less-than-25% owners of such a business or artificial person is encouraged to also be listed below.

**Name of >10% Owner Business or Artificial Person:**

--

Names of owners of the >10% Owner Business or Artificial Person (“Second Tier Owner”)	Owner’s Principal Place of Business Street Address	% of Interest

**Name of other >10% Owner Business or Artificial Person:**

--

Names of owners of the >10% Owner Business or Artificial Person ("Second Tier Owner")	Owner's Principal Place of Business Street Address	% of Interest

B. If any Second Tier Owner identified above is an artificial person, the natural or artificial owners of such Second Tier Owner who have held more than 49% of the shares or interest in the Bidder/Offeror/Prospective Contractor (Third Tier Owners) are as follows [if none, please so state]:

Second Tier Owner Name \_\_\_\_\_

Name of Third Tier Owner	Principal Place of Business Street Address	% of Interest
_____	_____	_____
_____	_____	_____
_____	_____	_____

C. If the name of no natural person has been identified as an owner, or a Second or Third Tier Owner of the Bidder/Offeror/Prospective Contractor, please identify the name, position, address, and contact information of the natural person having the authority and responsibility for the Bid/Offer/Proposal/Prospective Contract, and the name of any natural person who has the authority and power to remove and replace the designated responsible person:

Name of Natural Person	Position	Street Address of Principal Place of Business	Phone Number, Email Address, and other Contact Information

D. Further, I say that the persons who have received or are entitled to receive a commission, gratuity, contingent fee or other compensation to solicit, secure, or assist in obtaining business related to the Bid/Offer/Proposal/Prospective Contract for which this Affidavit is submitted are as follows (if none, please so state):

Name	Principal Place of Business Street Address	Amount of Compensation
_____	_____	_____
_____	_____	_____

E. Further, I say that the persons who have directly or indirectly participated in this solicitation and who are also employees of the government of Guam or the government of the United States, if federal funds are to be used

in the payment of the contract related to the Bid/Offer/Proposal/Prospective Contract for which this Affidavit is submitted, are as follows (if none, please so state):

Name	Principal Place of Business Street Address
_____	_____
_____	_____

F. Regardless of any ownership interest, the following individuals have the power to control the performance of the contract or to control the Bidder/Offeror/Prospective Contractor, directly or indirectly:

Name	Principal Place of Business Street Address
_____	_____
_____	_____

G. Until award of the contract, and throughout the term of any contract awarded to the Bidder/Offeror/Prospective Contractor represented herein, I agree to promptly make any disclosures not made previously and update changes in ownership, identities of owners and other required information, interests, compensation or conflicts of the persons required to be disclosed. I understand that failure to comply with this requirement shall constitute a material breach of contract.

H. I hereby declare under penalty of perjury under the laws of Guam that the foregoing is true and correct.

Executed on: \_\_\_\_\_(date)

---

Signature of one of the following:  
Bidder/Offeror/Prospective Contractor, if a licensed individual  
Owner of sole proprietorship Bidder/Offeror/Prospective  
Contractor  
Partner, if the Bidder/Offeror/Prospective Contractor is a  
partnership  
Officer, if the Bidder/Offeror/Prospective Contractor is a  
corporation

**DECLARATION RE: CONTINGENT FEES  
(AG Form 007)**

\_\_\_\_\_ [state name of declarant signing below], hereby declares that:

1. The name of the bidding/offering company or individual is [state name of company]

\_\_\_\_\_

2. As a part of the bidding/offering company's bid or proposal, to the best of my knowledge, the offering company has not retained any person or agency on a percentage, commission, or other contingent arrangement to secure this contract. This statement is made pursuant to 2 GAR Division 4 § 11108(f).

3. As a part of the bidding/offering company's bid or proposal, to the best of my knowledge, the bidding/offering company has not retained a person to solicit or secure a contract with the government of Guam upon an agreement or understanding for a commission, percentage, brokerage, or contingent fee, except for retention of bona fide employees or bona fide established commercial selling agencies for the purpose of securing business. This statement is made pursuant to 2 GAR Division 4 § 11108(f).

4. I make these statements on behalf of myself as a representative of the bidder/offeror, and on behalf of the Bidder/Offerors officers, representatives, agents, subcontractors, and employees.

I hereby declare under penalty of perjury under the laws of Guam that the foregoing is true and correct.

\_\_\_\_\_  
Signature of one of the following:

Bidder/Offeror, if the bidder/offeror is an individual; Partner, if the bidder/offeror is a partnership; Officer, if the bidder/offeror is a corporation.



## CONFLICT OF INTEREST GUIDELINES

Offerors shall follow these Conflict of Interest (COI) Guidelines when submitting any Proposal in response to a federally funded Port Authority of Guam solicitation or procurement or when entering into any federally funded Contract with Port Authority of Guam. The Contractor shall follow these COI Guidelines throughout the period during which the Proposal/Bid is open or the Contract is in effect. An Offeror shall provide the COI Guidelines and associated COI Disclosure Form to all of its Subconsultants and Subcontractors at any tier of a Proposal or Contract and shall ensure that the Offeror and each of its Subconsultants or Subcontractors make any disclosures required by these guidelines or as required by a specific Procurement or Contract. The Port Authority of Guam will follow and apply these COI Guidelines when conducting Port Authority of Guam procurements.

### **1. Definitions.**

The definitions that apply to these COI Guidelines and the Port Authority of Guam's COI Disclosure Form are at the end of this document.

### **2. Required Disclosures.**

**Submittal of a Correct and signed COI Disclosure Form is required if any of the following apply (note that for the purposes of these COI Guidelines "Public Employee" includes all Port Authority of Guam employees):**

- an Offeror or any of its Associates have any Apparent, Potential, or Actual Conflicts of Interest per these COI guidelines or per the criteria of any COI Form included as part of a Procurement or Contract;
- a Procurement or Contract document specifically requires submittal of a COI Disclosure Form (e.g., if the prospective Project includes preparation of an Environmental Impact Statement or Environmental Assessment, submittal of COI Disclosure Forms is always required.);
- an Offeror has any changes to its staffing or organization (whether before or after entering into a Contract) that result in an Apparent, Potential or Actual Conflict of Interest per these guidelines or per the criteria of any COI form associated with a particular Procurement or Contract. Any such changes shall be disclosed within 10 business days via submittal of a complete and signed COI Disclosure Form.
- the response to any of the following questions is "yes" (with respect to a Procurement or current Contract with Port Authority of Guam):
  1. Is any Associate of the Offeror a former employee of Port Authority of Guam (within the last year)?
  2. Is any Associate of the Offeror a Relative, Immediate Family Member, or Member of the Household of a current employee of Port Authority of Guam who had or may have a role in this Procurement, Authorization of the Contract, Contract administration, or oversight of the Contractor's performance?
  3. Does the Offeror or any Associate of the Offeror have an Actual, Apparent or Potential Conflict of Interest ("Individual" or "Organizational") with regard to any member of an Port Authority of Guam Procurement evaluation or selection team?
  4. Did the Offeror or any Associate of the Offeror conduct prior work on the Project described in the Procurement, or participate in preparing any part of the Procurement or any documents or reports related to the Procurement or to which the Procurement refers?
  5. Does the Offeror or any Associate of the Offeror have any past, present or currently planned interests which are an Actual, Apparent, or Potential Conflict of Interest ("Individual" or "Organizational") with respect to performing the work for Port Authority of Guam?
  6. Has the Offeror or an Associate of the Offeror offered to a Public Employee, or is the Offeror aware of any Public Employee that has solicited or received, directly or indirectly, any pledge or promise of employment or other benefit based on the understanding that the Public Employee's vote, official action or judgment would be influenced thereby?
  7. Has (or will) the Offeror or an Associate of the Offeror provided a direct beneficial financial interest to any person within one year after the person ceased to hold a position as a Public Employee who was involved in the Procurement or Authorization for the Contract, or is the Offeror aware of any such person or Public Employee who has or will receive a direct beneficial financial interest within the one-year period?
  8. Is the Offeror aware of any current or former Public Employee that has an Actual, Apparent, or Potential Conflict of Interest with respect to the Procurement or award of this Contract or performing the work for Port Authority of Guam?
  9. Does the prospective Contract include development of an environmental assessment (EA) or environmental impact statement (EIS)?
  10. If a Procurement is to obtain personal services for the purpose of administering, managing, monitoring, inspecting, evaluating compliance with or otherwise overseeing a public contract, is the Offeror or an Associate or an Affiliate of the Offeror a party to the subject public contract?
  11. Has the Offeror or any Associate of the Offeror entered into any contract(s) with Port Authority of Guam for the purpose of advising or assisting in developing any part of the solicitation documents, including specifications,

requirements, a scope or statement of work, an invitation to bid, a request for proposals or other documents and materials used in, or related to this procurement?

If none of the foregoing apply, an Offeror shall provide a written and signed certification (specified by Port Authority of Guam) that the Offeror has read and complied with these COI Guidelines and the COI Disclosure Form and did not answer Yes to any of the questions, or, if required by the Port Authority of Guam, the Offeror shall complete and submit a Correct and signed COI Disclosure Form.

An Offeror shall incorporate in each required COI Disclosure Form any COI disclosure information provided by its staff and attach COI Disclosure Forms from each of its Subcontractors (that have required disclosures of conflicts or potential conflicts of interest), prior to such Offeror performing any services under a Contract.

The COI Disclosure Form is attached to the solicitation as a mandatory form that must be signed and submitted with Offeror's Proposal.

### **3. Governing Standards.**

Both Guam and federal laws govern disclosure and management of conflicts of interest in contracting processes. The disclosure requirements of these COI Guidelines apply to all Port Authority of Guam contracting activities {Architectural and Engineering (A&E) and non-A&E, public improvements, goods, and trade services} without regard to which particular federal or Guam laws govern the activity. There are also Standards of Conduct Policies for conflicts of interest regarding current Port Authority of Guam employees, and the employment of former Port Authority of Guam employees, which are applicable to this procurement, and are explained below.

#### **Standards of Conduct Policy Regarding Former Port Authority of Guam Employees**

When employees of firms which compete for or have Contracts with the Port Authority of Guam come to work for the Port Authority of Guam, and when Port Authority of Guam employees go to work for firms which compete for or have Contracts with the Port Authority of Guam, a Potential Conflict of Interest may exist.

Use of a former Port Authority of Guam employee by an Offeror on the same, or substantially similar Procurement, for which the employee performed a role or function for the Port Authority of Guam, unless mitigated to the satisfaction of the Port Authority of Guam, is prohibited for a period of one year following separation of employment with the Port Authority of Guam. Roles and functions of particular concern include drafting specifications or statements of work, reviewing or scoring a bid or proposal, authorizing service or assigning work, awarding a Contract, administering a Contract, or overseeing Contractor's performance. The Port Authority of Guam may determine that the role or Procurement is not substantially similar because of differences in location of the Project or work, because of the type and method of Procurement, because the employee did not participate personally or substantially in the procurement, because the role performed was minor in nature, such as a technical sufficiency review, or because the Civil Service Commission has granted the employee an applicable waiver. Examples of mitigation that may, in appropriate situations, be acceptable to the Port Authority of Guam include separation of certain decision-making functions concerning the Project, not using the employee in preparation of proposals but allowing them to perform work on the Project, and not having the employee have direct contact with Port Authority of Guam staff formerly under his/her supervision.

For each Procurement, Offerors shall disclose to Port Authority of Guam the identification of any of Offeror's employee(s) that had been employed by Port Authority of Guam within the twelve-month period prior to the submission date for the Proposal or bid. Each Offeror's disclosure shall include a signed statement by the former Port Authority of Guam employee of their proposed role for the Offeror in the particular Procurement and any resulting Contract. Failure of an Offeror to disclose such relationship or to remedy such potential violation will result in the rejection of the Offeror's bid or cancellation of the Contract with the Port Authority of Guam as well as being grounds for cancellation of an Offeror's prequalification or designation of an Offeror as ineligible for future Procurements as not being a responsible bidder. (Also see below regarding the ban on any direct beneficial or financial interest.)

#### **Standards of Conduct Regarding Current Port Authority of Guam Employees Conflicts of Interest**

The Guam Procurement Law statutory and regulatory framework, as generally applied, addresses conflicts of interest in public contracting by emphasizing the need for open and impartial Procurement methods and by prohibiting certain conflicts of interest involving public officials. The following statutes and administrative rules establish Guam's general policies and the restrictions and prohibitions regarding conflicts of interest for public contracts and Public Employees:

- The policies of the Guam Procurement Law (5 GCA § 5001, et seq) encourage public contracting competition that supports openness and impartiality to the maximum extent possible, while recognizing that the nature of effective and meaningful competition depends upon the service being procured.
- According to 5 GCA §§ 5001(b), 5003, and 5625, a sound and responsive public contracting system should instill public confidence through ethical and fair dealing, honesty, and good faith on the part of government officials and those who do business with the government.
- Article 11 of the Guam Procurement Law, Ethics in Public Contracting, and Article 2 of the Standards of Conduct for Elected Officers, Appointed Officers and Public Employees of the Government of Guam prohibit conflicts of interest of Public Employees and prohibit Public Employees from obtaining outside financial benefits for the exercise of their official duties. Among the prohibitions are offering a public employee a fee, a pledge of future employment, or anything valued in excess of \$200 based on an understanding that the offer would influence the public employee's official action or judgment.
- 5 GCA § 5632(a) provides the following: "Contemporaneous Employment Prohibited. Except as may be permitted by regulations pursuant to this Chapter or pursuant to Title 4 GCA, or rulings of the Civil Service Commission pursuant to this Chapter, it shall be a breach of ethical standards for any employee who is participating directly or indirectly in the procurement

process to become or be, while such an employee, the employee of any person contracting with the governmental body by whom the employee is employed. Notice of this provision shall be provided in accordance with regulations promulgated by the Civil Service Commission.”

- 5 GCA § 5632(c) and (d) provide the following: “(c) Disqualification of Business When an Employee Has a Financial Interest. It shall be a breach of ethical standards for a business in which an employee has a financial interest knowingly to act as a principal, or as an agent for anyone other than the Territory, in connection with any:

- (1) judicial or other proceeding, application, request for a ruling or other determination;

- (2) contract;

- (3) claim; or

- (4) charge or controversy; in which the employee either participates personally and substantially through decision, approval, disapproval, recommendation, the rendering of advice, investigation or otherwise, or which is the subject of the employee’s official responsibility, where the Territory is a party or has a direct and substantial interest.

- (d) Selling to the Territory After Termination of Employment is Prohibited. It shall be a breach of ethical standards for any former employee, unless the former employee’s last annual salary did not exceed Twelve Thousand Dollars (\$12,000.00), to engage in selling or attempting to sell supplies, services other than personal services, or construction to the Territory for ninety (90) days following the date employment ceased.

The term sell as used herein means signing a bid, proposal, or contract; negotiating a contract, contracting any employee for the purpose of obtaining, negotiating or discussing changes in specifications, price, cost allowances or other terms of a contract; settling disputes concerning performance of a contract; or any other liaison activity with a view toward the ultimate consummation of a sale although the actual contract therefor is subsequently negotiated by another person; provided, however, that this Section is not intended to preclude a former employee from accepting employment with private industry solely because the former employee’s employer is a contractor with this Territory, nor shall a former employee be precluded from serving as a consultant to this Territory.”

- 4 GCA § 15201 states: “No employee shall solicit, accept, or receive, directly or indirectly, any gift valued singly or in the aggregate from a single source in excess of \$200, whether in the form of money, prize, service, loan, travel, entertainment, hospitality, thing or promise, or in any other form, when a reasonable person would infer that the gift is intended to influence the employee in the performance of that individual's official duties or is intended as a reward for any official action on that individual's part.”

- 4 GCA § 15204 (a), (b), (c), and (d) provide: “No employee shall use or attempt to use an official position to secure or grant unwarranted privileges, exemptions, advantages, contracts, or treatment, for himself or herself, a spouse, children, or others, including but not limited to the following:

- (a) seeking other employment or contract for services by the use or attempted use of the individual's office or position;

- (b) accepting, receiving, or soliciting compensation for the performance of official duties or responsibilities except as provided by law;

- (c) using government time, equipment, or other facilities for private business purposes;

- (d) soliciting, selling, or otherwise engaging in a financial transaction with a subordinate or a person or business whom the employee inspects or supervises in official capacity.”

- 4 GCA § 15205 (a), (b), (c), (d), and (e) provide: “Conflicts of Interest.

- (a) No employee shall take any official action directly affecting:

- (1) business or other undertaking in which the employee has a financial interest; or

- (2) private undertaking in which the employee is engaged as legal counsel, advisor, consultant, representative, or other agency capacity. A department head who is unable to be disqualified on any matter described in item (1) or (2) of this Subsection may be in violation of this Subsection even if the individual has complied with the disclosure requirements of § 15208; and a person whose position on a board, commission or committee is mandated by statute, resolution or executive order to have particular qualifications shall only be prohibited from taking official action that directly and specifically affects a business or undertaking in which such person has a financial interest; provided that the financial interest is related to the member's particular qualifications.

- (b) No employee shall acquire financial interests in any business or other undertaking which the employee has reason to believe may be directly involved in official action to be taken by the employee.

- (c) No employee shall assist any person or business or act in a representative capacity before any territorial agency for any compensation in any transaction involving the Territory.

- (d) No employee shall assist any person or business or act in a representative capacity for a fee or other compensation to secure passage of a bill or to obtain a contract, claim, or other transaction or proposal in which the employee has participated or will participate as an employee, nor shall the employee assist any person, or business, or act in a representative capacity for a fee or other compensation on such bill, contract, claim, or other transaction or proposal before the Legislature or territorial agency of which the individual is an employee.

- (e) No employee shall assist any person or business or act in a representative capacity before a territorial agency for a fee or other compensation, on any bill, contract, claim, or other transaction or proposal involving official action by the agency if the employee has official authority over that agency unless such employee has complied with the disclosure requirements of § 15208.”

- 4 GCA § 15206 states: “Contracts.

(a) A territorial agency shall not enter into any contract with an employee or with a business in which an employee has a controlling interest, unless the contract has been awarded through an open, public process. A territorial agency may, however, enter into such contract without resort to competitive bidding process when, in the opinion of the General Services Agency or the procurement officer of that branch of government, the property or services does not fall within the purview of competitive bidding; provided that written justification for the non-competitive award of such contract be made a matter of public record and shall be filed with the Guam Ethics Commission at least ten (10) days before such contract is entered into. With regards to members of boards, commissions, and committees, this Subsection shall apply only to contracts entered into between a business in which a member has a controlling interest and a territorial agency in which the board, commission, or committee to which the individual is appointed has jurisdiction.

(b) A territorial agency shall not enter into a contract with any person or business which is represented or assisted in a material manner in the matter by a person who has been an employee of that agency within the preceding twelve (12) months and who participated while in 8 territorial office or employment in a material manner in the matter with which the contract is directly concerned.”

Port Authority of Guam’s COI Guidelines embody the intent of encouraging competition through openness, impartiality, and public disclosure of relevant information (and the avoidance of conflicts of interest) as described in Guam’s Procurement Law, Title 5, Chapter 5, Article 11, Ethics in Public Contracting; Title 4, Chapter 15, Standards of Conduct for Elected Officials, Appointed Officers, and Public Employees of the Government of Guam, The Guam Department of Administration Personnel Code of Conduct and Port Authority of Guam’s Standards of Conduct Policies or any other applicable governmental ethics policies.

The one-year prohibition against a Public Employee having a direct beneficial financial interest in a public contract as provided in 5 GCA § 5632(b) would generally preclude the person from working under the public contract and from representing the Offeror in dealings with the public agency for whom the person had worked. Sharing in the general profits of the Offeror (such as a year-end bonus for overall corporate profits) is likely not a direct beneficial financial interest, however, a bonus or other compensation paid just on the basis of the public contract would be subject to the prohibition.

**Standards of Conduct for Offerors and Contractors, and Organizational Conflicts of Interest Policy**

It is the policy of Port Authority of Guam to avoid, neutralize, or mitigate organizational conflicts of interest that might exist for all procurements. Each individual contracting situation shall be examined on the basis of its particular facts and the nature of the proposed contract. The exercise of common sense, good judgment, and sound discretion is required in both the decision on whether a significant potential conflict exists and, if it does, the development of an appropriate means for resolving it. The principles underlying this policy are: (1) preventing the existence of conflicting roles that might bias an Offeror’s judgment; and (2) Preventing unfair competitive advantage. In addition to the other situations described in these COI Guidelines, an unfair competitive advantage exists where an Offeror competing for award of any Port Authority of Guam contract possesses: (1) proprietary information that was obtained from a Public Employee without proper authorization; or (2) source selection information that is relevant to the contract but is not available to all competitors, and such information would assist that Offeror in obtaining the contract.

The following situations constitute organizational conflicts of interest. This listing is not exhaustive:

- A conflict of interest exists when an Offeror that provides systems engineering and technical direction for a system is awarded a contract to supply the system or any of its major components; or is a subcontractor or consultant to a supplier of the system or any of its major components; even if the Offeror did not have overall contractual responsibility for the system’s development, its integration, assembly, and checkout, or its production. In this example, systems engineering includes a combination of substantially all of the following activities: determining specifications, identifying and resolving interface problems, developing test requirements, evaluating test data, and supervising design. Technical direction includes a combination of substantially all of the following activities: developing work statements, determining parameters, directing other contractors’ operations, and resolving technical controversies. In performing these activities, a contractor occupies a highly influential and responsible position in determining a system’s basic concepts and supervising their execution by other contractors. Therefore, this Offeror should not be in a position to make decisions favoring its own products or capabilities.
- A conflict of interest exists when an Offeror prepares and furnishes complete specifications covering non-developmental items, to be used in a competitive procurement, and submits a proposal or bid to be allowed to furnish these items, either as a prime contractor or as a subcontractor, for a reasonable period of time including, at least, the duration of the initial production contract.
- If a single contractor drafts complete specifications for non-developmental equipment, that contractor should be eliminated for a reasonable time from competition for production based on the specifications. This should be done in order to avoid a situation in which the contractor could draft specifications favoring its own products or capabilities. In this way the Government can be assured of getting unbiased advice as to the content of the specifications and can avoid allegations of favoritism in the award of production contracts.
- When an Offeror prepares, or assists in preparing, a statement of work, scope of services, or technical specifications to be used in competitively acquiring a system or services, or provides material leading directly, predictably, and without delay to such a statement of work, scope of services, or technical specifications, it is a conflict of interest if that Offeror submits a Proposal or bid to supply the system, major components of the system, or the services, unless:
  - (i) It is the sole source;
  - (ii) It has participated in the development and design work; or

(iii) More than one contractor has been involved in preparing the statement of work, scope of services, or technical specifications.

- Agencies should normally prepare their own statements of work, and scopes of services. When contractor assistance is necessary to prepare the statement of work or scope of services, the contractor is in a position to favor its own products or capabilities. To overcome the possibility of bias, Offerors are prohibited from supplying a system or services acquired on the basis of a statement of work or scope of services growing out of their services, unless:
  - (i) It is the sole source;
  - (ii) It has participated in the development and design work; or
  - (iii) More than one contractor has been involved in preparing the statement of work, scope of services, or technical specifications.
- It is a conflict of interest for a contractor to participate in the evaluation of products or services that it offers. Contracts for the evaluation of offers for products or services shall not be awarded to an Offeror that will evaluate its own offers for products or services, or those of a competitor.

The following situations are not considered to constitute organizational conflicts of interest. This list is not exhaustive:

- In development work, it is normal to select firms that have done the most advanced work in the field. These firms can be expected to design and develop around their own prior knowledge. Development contractors can frequently start production earlier and more knowledgeably than firms that did not participate in the development, and this can affect the time and quality of production, both of which are important to the Government. In many instances the Government may have financed the development. Thus, while the development contractor has a competitive advantage, it is an unavoidable one that is not considered unfair; hence this is not considered an organizational conflict of interest.
- It is not an organizational conflict of interest for Offerors that furnish, at Government request, specifications or data regarding a product they provide, even though the specifications or data may have been paid for separately or in the price of the product.
- It is not an organizational conflict of interest where Offerors, acting as industry representatives, help Government agencies prepare, refine, or coordinate specifications, regardless of source, provided this assistance is supervised and controlled by Government representatives.

It is further the policy of Port Authority of Guam to restrict Offeror's use of confidential or proprietary information obtained from previous affiliations with the Port Authority of Guam or the Government when competing for Port Authority of Guam contracts. When a contractor requires proprietary information to perform a Government contract and can use the leverage of the contract to obtain it, the contractor may gain an unfair competitive advantage unless restrictions are imposed. These restrictions protect the information and encourage companies to provide it when necessary for contract performance. They are not intended to protect information: (1) furnished voluntarily without limitations on its use; or (2) available to the Government or contractor from other sources without restriction.

In addition, a contractor that gains access to proprietary information of other companies in performing advisory and assistance services for the Government must agree with the other companies to protect their information from unauthorized use or disclosure for as long as it remains proprietary and refrain from using the information for any purpose other than that for which it was furnished. The Offeror shall provide Port Authority of Guam with copies of these agreements and ensure that they are properly executed.

Contractors also obtain proprietary and source selection information by acquiring the services of marketing consultants which, if used in connection with an acquisition, may give the contractor an unfair competitive advantage. Contractors should make inquiries of marketing consultants to ensure that the marketing consultant has provided no unfair competitive advantage, and must disclose these relationships to Port Authority of Guam on the COI Disclosure Form.

#### **Specific Federal Standards—Procurements Related to Design-Build and Design-Bid-Build**

Pursuant to 23 USC § 112(b)(3), the FHWA has promulgated administrative rules that affect federally funded Design-Build procurements and related procurements. These rules, which are in Chapter 23 of the CFR Part 636, are used as the basis for Port Authority of Guam's guidelines on the subject and specifically regulate both Organizational and Individual Conflicts of Interest. Port Authority of Guam's COI Guidelines incorporate a number of concepts from these federal provisions.

The primary rule governing Organizational Conflicts of Interest in Design-Build transactions is 23 CFR § 636.116. This rule affects not only Design-Build procurements, but also "any contract for engineering services, inspection or technical support in the administration of the Design-Build contract." Following is a summary of this federal rule (Port Authority of Guam's COI Guidelines apply this rule to design-bid-build and non-A&E activities as well):

Generally, a consultant who assists the state in preparing a Request for Proposals (RFP) document may not, subsequently, propose in response to the RFP. However, the state may determine that the consultant does not have a conflict of interest for a subsequent Procurement, if the consultant furnished only "low-level" documents that were incorporated into the RFP and made available to all offerors, and did not assist the state in the development of instructions to offerors or evaluation criteria for the RFP. These Design-Build regulations also apply to "improper business practices and personal conflicts of interest" of the Port Authority of Guam's selection team members. 23 CFR § 636.117 indicates that Federal Acquisition Regulations ("FARs"—specifically 48 CFR Part 3, Improper Business Practices and Personal Conflicts of Interest) will apply to the state's selection team members in the absence of relevant state laws and procedures. These regulations require government business to be "above

reproach,” conducted “with complete impartiality and with preferential treatment for none” and with “the highest degree of public trust and an impeccable standard of conduct” to avoid “even the appearance of a conflict of interest.” In design-bid-build transactions, where engineering services are procured separately from the construction services, ordinarily the consulting Offeror providing the engineering services is not eligible to bid on the construction work for the Project.

No Offeror or any Associate of an Offeror in connection with a Transportation Project shall have, directly or indirectly, any interest, other than his employment or retention by a State or other governmental instrumentality, in any Contract in connection with such Project. No firm or an Associate of an Offeror shall have, directly or indirectly, any interest in any real property acquired or to be acquired for a Project unless such interest is openly disclosed upon the records of Port Authority of Guam and such Offeror or Associate has not participated and will not participate in such acquisition for and in behalf of Port Authority of Guam (see 23 CFR § 1.33).

#### **Specific Federal Standards - National Environmental Policy Act (NEPA)**

No Offeror preparing or providing environmental analysis or impact documents relating to a Project, including draft and final Environmental Assessments (EA) or Environmental Impact Statements (EIS) may have a financial or other interest in the outcome of the Project. A financial or other interest in the outcome of the Project includes any known benefits other than general enhancement of professional reputation, and includes any agreement, enforceable promise, guarantee or expectation of future work on the Project as well as any indirect benefit the Offeror is aware of such as if the Project would aid proposals sponsored by the Offeror’s other clients. Compliance with 40 C.F.R. 1506.5(c) is required, which includes the requirement for a conflict of interest disclosure statement from each Offeror establishing that the Offeror does not have a financial or other interest in the Project.

#### **4. COI Considerations Related to Previous Work on Projects.**

No Offeror that has previously performed services on behalf of Port Authority of Guam for a Project may be a Proposer or participate as an equity owner, team member, Subcontractor of or to a Proposer on the Project, or have a financial interest in any of the foregoing entities with respect to the Project, unless Port Authority of Guam is satisfied in its sole discretion that:

- (a) such services were completed prior to initiation of the Procurement for the Project (exceptions may apply for NEPA services on a case-by-case evaluation of the project specifics against the applicable CFRs);
- (b) such services included only Low-Level Documents and did not include development of instructions to offerors or evaluation criteria for the RFP;
- (c) such services did not provide the Offeror with access to or knowledge of Port Authority of Guam confidential or inside information that could provide an unfair competitive advantage with respect to the Procurement;
- (d) the prior Contract and information provided to the Offeror in the performance of its services are either irrelevant to the Procurement or are available on an equal and timely basis to all Proposers;
- (e) the work product from the Offeror incorporated into or relevant to the Procurement is available through Public Disclosure on an equal and timely basis to all Proposers; and
- (f) any environmental documents prepared by the Offeror have been determined to be objective, and that the Port Authority of Guam demonstrated independent decision-making authority during the environmental process.

In such instances where Port Authority of Guam is satisfied in the manner described above, Port Authority of Guam may still, in its sole discretion, restrict the scope of Procurement services for which the Offeror shall be eligible to perform in order to further the intent and goals of these COI Guidelines.

Public Disclosure of services or products is an important consideration in determining if an Organizational Conflict of Interest exists. All COI Disclosure Forms will be considered public records, as permitted under Guam’s Procurement Law.

#### **5. COI Disclosure Process.**

An Offeror shall certify its compliance with these COI Guidelines at the time of submitting a Proposal to Port Authority of Guam, during the Procurement Process, and during the time of performance of any awarded Contract with Port Authority of Guam. If submittal of COI Disclosure Form(s) is required per these COI Guidelines or a specific Procurement or Contract, an Offeror shall represent the correctness of a completed COI Disclosure Form. If an Offeror has any changes to its staffing or organization (whether before or after entering a Contract) that result in an Actual, Apparent or Potential Conflict of Interest (Individual or Organizational) per these COI Guidelines or per the criteria of any COI form associated with a particular Procurement or Contract, any such changes shall be disclosed within ten (10) business days via submittal of a Correct and signed COI Disclosure Form.

An Offeror shall assure that any COI Disclosure Form it submits includes any information required to be disclosed by its Subcontractors and other Associates, on behalf of the Offeror. An Offeror may submit either the Subcontractors’ separate COI Disclosure Forms or incorporate Subcontractor information into its own COI Disclosure Form. The disclosure required with the proposal applies the prime and all proposed Subcontractors that are identified or anticipated at the time of proposal submission.

The identification, assessment, and management of Actual or Potential Conflicts of Interest are joint tasks among Port Authority of Guam, the Offeror and the Offeror’s team. An Offeror must work together with Port Authority of Guam in an atmosphere of candor and accountability during the period of negotiation or performance of the Contract with Port Authority of Guam. Port Authority of Guam makes the final determination as to the adequacy of any COI disclosures or COI management plan offered by the Offeror.

Port Authority of Guam’s COI determination is based on a number of factors such as:

- ✓ Situational Facts – description of the situation and all known facts specific to the actual or perceived COI
- ✓ Type of Work - specific product or service and Contract(s) involved
- ✓ Relationship to Management - specific interactions with Port Authority of Guam decision-makers
- ✓ Public Disclosure - timing and availability of product or service

The specific facts disclosed in any COI situation will be unique to that situation. Therefore, the decisions and conclusions reached in one situation may or may not be directly applicable to another. For example, the definition of “low-level” documents does not isolate an Offeror producing such documents from a potential COI situation. The ultimate determination will take into account the other factors described above.

## **6. Examples of Conflict of Interest Situations.**

Port Authority of Guam offers the following examples to better illustrate conflict of interest situations that may arise during the course of the performance of a Personal Services Contract, Purchase Request, Purchase Order, or any Contract entered into between Port Authority of Guam and an Offeror, or during any Government of Guam Procurement process, in order to provide guidance to Offerors as they determine if their specific situations warrant disclosure, evaluation, and management.

1. A Design-Build solicitation requires the responding teams to propose how to manage site features that were uncovered by a geotechnical engineering Offeror. The Offeror’s reports to Port Authority of Guam on the Project are available to the public. A multi-specialty engineering Offeror that is the parent company of the geotechnical engineering Offeror submits a proposal to design the overall Project. Depending on the particular mitigating facts, Port Authority of Guam might determine in writing that the multi-specialty engineering Offeror is eligible to propose.
2. Port Authority of Guam seeks comprehensive project management services for a series of Transportation Projects. One of the proposing Offerors employed a senior official from Port Authority of Guam who played a significant role in providing direction for the solicitation, six months ago. Port Authority of Guam initially assesses this situation as a potential Organizational Conflict of Interest and provides information to potential Proposers of this assessment through an addendum to the RFP. In its proposal, the Proposer provides mitigating information and written assurances that this individual works in an area of the company that will not be working on their program management proposal and that the individual will be isolated inside the company from any information associated with the program, will not be lobbying Port Authority of Guam, will not engage in any activities that would violate the Port Authority of Guam Code of Conduct Policy for the prescribed one-year period, and for a period of one year will not have a direct beneficial interest in the contract. Depending on the particular facts, Port Authority of Guam might determine that, while the proposing Offeror has a potential Organizational Conflict of Interest, that conflict has been adequately mitigated and the Offeror will not be disqualified from submitting a proposal.
3. Port Authority of Guam issues an RFP for design and oversight of an intelligent system to collect bridge tolls. The RFP provides that companies having a financial interest in the relevant telecommunications hardware will be excluded from bidding. A company under common ownership with a major electronics manufacturer desires to bid. Port Authority of Guam initially assesses this situation as an Organizational Conflict of Interest, because it cannot know in advance whether the hardware products of this electronics manufacturer would be used in the Project, and Port Authority of Guam informs potential Proposers of its concern related to this type of conflict via addendum to the RFP. In its proposal, the company offers no mitigating facts or organizational plans that address Port Authority of Guam’s concerns about the conflict. Depending on the particular facts, Port Authority of Guam determines that the company has an actual conflict of interest.
4. Port Authority of Guam seeks advice of an industry advisory committee to formulate the specifications for an information technology (IT) RFP. An IT Offeror that participated in the advisory committee wishes to submit a proposal in response to the RFP. Depending on the particular facts, Port Authority of Guam might determine that the role of the Offeror was to represent the industry in the context of a public meeting where other Offerors were invited to submit comments, and that the Offeror therefore does not have an Organizational Conflict of Interest.
5. Port Authority of Guam contracts with an A&E Offeror to develop “low-level” documents prior to establishing a schedule for an RFP in which the “low level” documents, still under development, will be used by prospective Proposers. The A&E Offeror has attended the pre-proposal meeting and wishes to propose on the RFP. Port Authority of Guam determines that the company has a potential Organizational Conflict of Interest because of the fact that the low-level documents have not been made public and the Offeror will still be developing the documents during the solicitation. The company then mitigates the potential conflict of interest by suspending development of new reports during the open period of the solicitation and making all data and information sources available on an Port Authority of Guam website prior to the RFP release. Port Authority of Guam determines that the potential conflict has been adequately managed and the Offeror will not be disqualified from submitting a proposal or being part of the proposing team.
6. Port Authority of Guam contracts with a consulting Offeror to assist Port Authority of Guam in the development of an RFP and sample Contract for a Design-Build Procurement for construction of certain Transportation Projects. The Offeror has close contact with Port Authority of Guam decision-makers in the development of the evaluation criteria for the RFP and the proposed Contract terms, and that information is shared throughout the Offeror with all management and technical personnel. The Offeror will not be able to submit a proposal in the design-build Procurement, or participate as a team member with an Offeror submitting a proposal in response to the RFP.
7. Port Authority of Guam seeks comprehensive program management services for a series of Transportation Projects. Prior to release of the RFP, Port Authority of Guam shared its interpretation of the applicable conflict of interest requirements with the industry. One of the proposing Offerors has a related entity with a planned interest in future design-build construction work related to the transportation program. The COI Disclosure Form does not clearly state whether the related entity is a subsidiary, major partner, Subcontractor, or affiliate of a Subcontractor. The proposing

Offeror describes its intent to restrict the flow of information concerning construction Projects to the related entity and thereby to its affiliate construction company but does not clarify how much information will be shared between the principal and its Subcontractors and affiliates or the controls placed on the principal Subcontractor-affiliate relationship. Furthermore, the proposing Offeror has provided mitigation information, indicating that the related entity will not participate in providing services under the program management Contract (i.e., design, source selection, award of Contract, etc.). Port Authority of Guam may conclude the proposing Offeror does not have a conflict of interest that detracts from its eligibility for the program management award. Port Authority of Guam may determine that the related entity has a conflict of interest in future design-build construction work related to the bridge repair and replacement program that has not been adequately mitigated by the measures and information provided by the proposing Offeror. As a result, if the proposing Offeror is awarded the program management Contract, the related construction company will be ineligible for construction work under the program. This determination will depend upon the precise relationship between the related entity and the Proposer.

8. Completion of a project may encourage construction of a shopping center or industrial park from which an Offeror stands to benefit. If an Offeror is aware that it has such an interest in the decision on the proposal, it will be disqualified from preparing an EIS to preserve the objectivity and integrity of the NEPA process.
9. Port Authority of Guam issues an RFP for A&E services to prepare plans, specifications, and estimate (PS&E) to replace a bridge. The PS&E will be completed as part of a design-bid-build process. One of the A&E firms proposing on the design services owns XYZ Inc., a subsidiary that provides program management services to Port Authority of Guam under a separate contract. Port Authority of Guam's intent, as advertised in the RFP, is to use XYZ Inc. for administration and oversight of the A&E design services for the bridge replacement project. The A&E firm that is the parent of XYZ Inc. would be ineligible for award of the A&E design contract.
10. Port Authority of Guam issues an IFB for construction services to replace a bridge. The replacement is being done using the design-bid-build process. One of the construction firms bidding on the public improvement project owns XYZ Inc., a subsidiary that provides construction contract administration and inspection services to Port Authority of Guam under a separate contract. Port Authority of Guam's intent, as advertised in the IFB, is to use XYZ Inc. for administration and inspection of the bridge replacement project. The construction firm that is the parent of XYZ Inc. would be ineligible for award of the construction contract.

#### DEFINITIONS

The following definitions apply to these COI Guidelines and the Port Authority of Guam's COI Disclosure Form:

**"Actual Conflict of Interest"** means that an individual or Offeror is unable to render impartial assistance or advice to Port Authority of Guam, has impaired objectivity in performing the Project work, or has an unfair competitive advantage. "Actual Conflict of Interest" means any action or any decision or recommendation by a person acting in a capacity as a public official, the effect of which would be to the private pecuniary benefit or detriment of the person or the person's relative or any business with which the person or a relative of the person is associated unless the pecuniary benefit or detriment arises out of the circumstances described in the definition for "Potential Conflict of Interest" (see definition below).

**"Affiliate"** (of an Offeror) means a person or entity that, directly or indirectly through one or more intermediaries, controls, is controlled by, or is under common control of the Offeror.

**"Apparent Conflict of Interest"** means that an individual or Offeror may reasonably be perceived to have an Actual Conflict of Interest or a Potential Conflict of Interest.

**"Associate"** (of the Offeror) means an employee, executive, director, key project personnel, consultant, contractor, or Subcontractor, or any immediate family member of the foregoing.

**"Authorization"** (of the Contract). A public contract is authorized by a Public Employee if the Public Employee participated substantially in the procurement selection process or performed a significant role in the selection of an Offeror or the execution of the Contract. A significant role includes recommending approval or signing of the Contract, including serving as a reference, recommending selection or serving on a selection committee or team, or having the final authorizing authority for the Contract.

**"Bidder"** means a legally operating business entity submitting a bid in response to a Procurement solicitation.

**"Conflict of Interest" or "COI"** means an Individual Conflict of Interest or Organizational Conflict of Interest and includes an Actual, Potential, or Apparent Conflict of Interest.

**"COI Disclosure Form"** means a manually signed disclosure of any Actual Conflict of Interest, Apparent Conflict of Interest or Potential Conflict of Interest documented in the form of Port Authority of Guam's COI Disclosure Form.

**"COI Guidelines"** refers to this document and all references herein.

**"Contract"** means an Agreement, Contract, Purchase Request (PR), Work Order Contract (WOC), Purchase Order (PO), or any other type agreement with Port Authority of Guam, regardless of what it may be called, for the procurement or disposal of supplies, services, or construction.

**"Contractor"** means a legally operating business entity that has been awarded a contract in response to a Procurement.

**"Correct"** means, in the context of determining the accuracy of a COI Disclosure Form, that the form, in all material respects, is complete, accurate, not misleading, and does not omit any material information.

**"Immediate Family Member"** (of the Public Employee) means a spouse, children, parents, brothers and sisters, grandparents and grandchildren, mothers-in-law and fathers-in-law, brothers-in-law and sisters-in-law, daughters-in-law and sons-in-law. Stepsiblings, stepchildren and stepparents shall also be regarded as immediate family.

**"Individual Conflict of Interest"** means that an individual has a conflict of interest because of a financial interest, gift, or other activities or relationships with other persons including but not limited to individuals with whom the individual has business, familial or household relationships.

**"Interest"** (in the context of a conflict of interest) means a direct or indirect interest and includes a personal as well as financial interest.



**“Low-Level Document”** means A&E, non-A&E and IT program or Project-related documents which provide a basic understanding of a specific aspect of the program or Project. With regard to A&E and related services, it means that the role of the consultant or subconsultant was limited to provision of preliminary design, reports, or similar “low-level” documents that will be incorporated into the solicitation, and did not include assistance in development of instructions to offerors or evaluation criteria.

**“Member of the Household”** (of the Public Employee) means any person who resides with the Public Employee.

**“Offeror”** means a Proposer or Bidder under a Procurement solicitation, a consultant or contractor under a Contract, or a Subcontractor at any tier of a Proposer, consultant, or contractor, and any partner or member of any of the foregoing. An Offeror includes all persons, individual or corporate, without regard to form of legal entity, and any partner or member of any of the foregoing.

**“Organizational Conflict of Interest”** means that a relationship or situation exists whereby an Offeror or any of its Associates has past, present, or currently planned interests or activities that either directly or indirectly (through a client, contractual, financial, organizational or other relationship) may relate to the work to be performed under the proposed Contract with Port Authority of Guam and which: (a) diminish the Offeror’s or an Associate’s capacity to give impartial, technically sound, objective assistance or advice; (b) may impair the Offeror’s or an Associate’s objectivity in performing the Contract; (c) may impair Port Authority of Guam’s objectivity in oversight of the Contractor’s performance; or (d) may result in an unfair competitive advantage. It does not include the normal flow of benefits from the performance of the Contract.

**“Potential Conflict of Interest”** means that an individual or Offeror, as a result of current plans, may reasonably be expected to have an actual conflict of interest. “Potential Conflict of Interest” means any action or any decision or recommendation by a person acting in a capacity as a public official, the effect of which could be to the private pecuniary benefit or detriment of the person or the person’s relative, or a business with which the person or the person’s relative is associated, unless the pecuniary benefit or detriment arises out of the following: (a) an interest or membership in a particular business, industry, occupation or other class required by law as a prerequisite to the holding by the person of the office or position; (b) any action in the person’s official capacity which would affect, to the same degree, a class consisting of all inhabitants of the state or a smaller class consisting of an industry, occupation or other group including one of which or in which the person, or the person’s relative or business with which the person or the person’s relative is associated, is a member or is engaged; or (c) membership in or membership on the board of directors of a nonprofit corporation that is tax-exempt under section 501(c) of the Internal Revenue Code.

**“Procurement”** means a Request for Proposals (RFP), Request for Quotes (RFQ), Request for Information (RFI), Invitation for Bid (IFB), or any other form of solicitation or Procurement by Port Authority of Guam.

**“Project”** means any proposed or existing undertaking pertaining to such programs that are assigned to Port Authority of Guam under applicable law.

**“Proposal”** means a bid, proposal, or other submission appropriate to a Procurement.

**“Proposer”** means a legally operating business entity submitting a Proposal in response to a Procurement.

**“Public Disclosure”** means the work product or service (in connection with the preparation of a Procurement) is available for public review and analysis for a reasonable amount of time, typically at least thirty (30) calendar days.

**“Public Employee”** means any person who is serving the government of Guam or any of its political subdivisions or any other governmental body as defined in 5 GCA § 5125 as an elected official, appointed official, employee, agent, or otherwise, irrespective of whether the person is compensated for the services. (For the purposes of these COI Guidelines, all Port Authority of Guam employees are considered Public Employees under this definition.)

**“Relative”** (of a Public Employee) means:

- any individual who is related to the public official as father, mother, son, daughter, brother, sister, uncle, aunt, first cousin, nephew, niece, husband, wife, father-in-law, mother-in-law, son-in-law, daughter-in-law, brother-in-law, sister-in-law, stepfather, stepmother, stepson, stepdaughter, stepbrother, stepsister, half brother, or half sister; or
- any individual for whom the Public Employee has a legal support obligation or for whom the Public Employee provides benefits arising from the Public Employee’s public employment or from whom the Public Employee receives benefits arising from that individual’s employment.

**“Subcontractor”** means a contractor or subcontractor at any tier lower than the awarded Contractor.

The non-Federal entity must maintain written standards of conduct covering conflicts of interest and governing the actions of its employees engaged in the selection, award and administration of contracts. No employee, officer, or agent may participate in the selection, award, or administration of a contract supported by a Federal award if he or she has a real or apparent conflict of interest. Such a conflict of interest would arise when the employee, officer, or agent, any member of his or her immediate family, his or her partner, or an organization which employs or is about to employ any of the parties indicated herein, has a financial or other interest in or a tangible personal benefit from a firm considered for a contract. The officers, employees, and agents of the non-Federal entity may neither solicit nor accept gratuities, favors, or anything of monetary value from contractors or parties to subcontracts. However, non-Federal entities may set standards for situations in which the financial interest is not substantial or the gift is an unsolicited item of nominal value. The standards of conduct must provide for disciplinary actions to be applied for violations of such standards by officers, employees, or agents of the non-Federal entity.

**CONFLICT OF INTEREST (COI) DISCLOSURE FORM**

**Government of Guam \*PORT AUTHORITY OF GUAM\* IFB No. PAG-004-24**

Offerors under Contract or proposing to enter into a Contract with \*PORT AUTHORITY OF GUAM\* must comply with the "Conflict of Interest Guidelines" attached to this solicitation. The definitions of terms used in this COI Disclosure Form shall be those provided in the Conflict of Interest Guidelines (note that "Public Employee" includes all \*PORT AUTHORITY OF GUAM\* employees).

**This COI Disclosure Form is submitted in response to:**

\*PORT AUTHORITY OF GUAM\*  RFP# \_\_\_\_\_ [or]  IFB# \_\_\_\_\_ (check only one)

Contract # \_\_\_\_\_ (if applicable)

Changes to COI Disclosure Form previously submitted for RFP # \_\_\_\_\_, IFB # \_\_\_\_\_, or Contract # \_\_\_\_\_ (if applicable)

**This COI Disclosure Form must be signed in ink by an authorized representative of Offeror to certify that it is correct. An Offeror's certification that its disclosure form is correct includes the disclosure by its Associates and Subcontractors.**

My signature certifies that as disclosed on or attached to the present form:

- (a) the Offeror's disclosures are complete, accurate, and not misleading.
- (b) the Offeror has provided the COI Guidelines to all Associates and Subcontractors (if any) and this form includes or has attached any required COI disclosures from those sources.

**I hereby certify that I am authorized to sign this COI Disclosure Form as an Authorized Representative for the Offeror identified below:**

**Complete Legal Name of Offeror:** \_\_\_\_\_

**Address:** \_\_\_\_\_

**Telephone:** \_\_\_\_\_

**Fax No:** \_\_\_\_\_

**Signature:** \_\_\_\_\_ **Date:** \_\_\_\_\_

**Please answer all questions "Yes", "No" or "N/A" (if uncertain answer "Yes.") If the answer to any of the questions is "Yes," then use the applicable "Comments" fields to:**

- (a) furnish all relevant facts that are necessary to make the response complete, accurate, and not misleading; and
- (b) identify any actions that must be taken to avoid, neutralize, or mitigate such conflict of interest (e.g. communications barriers, restraint or restriction upon future contracting activities, or other precaution)

**Please add additional sheets as necessary to respond to the "Comments" field.**

1. a) Is any Associate of the Offeror a former employee of \*PORT AUTHORITY OF GUAM\* within the last year? **No**  **Yes**   
 b) Is any Associate of the Offeror a Relative, Immediate Family Member, or Member of the Household of a current \*PORT AUTHORITY OF GUAM\* employee that had or will have any involvement with this Procurement or Contract Authorization? **No**  **Yes**

**If the answer to either of the above questions is "Yes", complete the attached "Relatives and Former \*PORT AUTHORITY OF GUAM\* Employees - Roles and Signatures" table (Part A and/or Part B, as applicable).**

2. Does the Offeror or any Associate of the Offeror have an Actual, Apparent or Potential Conflict of Interest ("Individual" or "Organizational") with regard to any known member of an \*PORT AUTHORITY OF GUAM\* Procurement evaluation or selection team? **No**  **Yes**  **Comments:**
3. Did the Offeror or any Associate of the Offeror conduct prior work on the Project described in the Procurement, or participate in preparing any part of the Procurement or any documents or reports related to the Procurement or to which the Procurement refers? **No**  **Yes**  **Comments:**
4. Does the Offeror or any Associate of the Offeror have any past, present or currently planned personal or financial interests which are an Actual, Apparent or Potential Conflict of Interest ("Individual" or "Organizational"), with respect to the

Procurement or award of this Contract or performing the work for \*PORT AUTHORITY OF GUAM\* or acquisition of any real property for the Project? **No**  **Yes**  **Comments:**

5. Has the Offeror or an Associate of the Offeror offered to a Public Employee, or is the Offeror aware of any Public Employee that has solicited or received, directly or indirectly, any pledge or promise of employment or other benefit based on the understanding that the Public Employee's vote, official action or judgment would be influenced thereby? **No**  **Yes**  **Comments:**

6. Has (or will) the Offeror or an Associate of the Offeror provided a direct beneficial financial interest to any person within two years after the person ceased to hold a position as a Public Employee who was involved in the Procurement or Authorization for the Contract, or is the Offeror aware of any such person or Public Employee who has or will receive a direct beneficial financial interest within the two-year period? **No**  **Yes**  **Comments:**

7. Is the Offeror aware of any current or former Public Employee that has an Actual, Apparent, or Potential Conflict of Interest with respect to the Procurement or award of this Contract or performing the work for \*PORT AUTHORITY OF GUAM\*? **No**  **Yes**  **Comments:**

8. Does the prospective Contract/WOC include development of an Environmental Assessment (EA) or Environmental Impact Statement (EIS)? **No**  **Yes**

**If yes**, in accordance with the disclosure statement requirements of Council on Environmental Quality Regulation, 40 C.F.R 1506.5(c), does the Offeror have any financial or other interest in the outcome of this Project; and/or does the Offeror have any agreement, enforceable promise, or guarantee to provide any future work on this Project?

**No**  **Yes**  **Comments:**

9. Have Subcontractors or other Associates furnished COI Disclosure Forms, separate from the present form, which included conflicts or potential conflicts of interest? (If yes, attach the disclosures.) **No**  **Yes**  **N/A**   
**Comments:**

10. If the prospective Contract/WOC includes personal services for the purpose of administering, managing, monitoring, inspecting, evaluating compliance with or otherwise overseeing a public contract, is the Offeror or an Associate or an Affiliate of the Offeror a party to the subject public contract? **No**  **Yes**  **N/A**  **Comments:**

11. Has the Offeror or any Associate of the Offeror entered into personal services contract(s) with \*PORT AUTHORITY OF GUAM\* for the purpose of advising or assisting in developing specifications, a scope or statement of work, an invitation to bid, a request for proposals, or other solicitation documents and materials related to this procurement? **No**  **Yes**  **Comments:**

**Relatives and Former \*PORT AUTHORITY OF GUAM\* Employees - Roles and Signatures**

For each employee of the Offeror that was employed by \*PORT AUTHORITY OF GUAM\* within the last year, state the job the employee performed for \*PORT AUTHORITY OF GUAM\*, the role the employee now serves for the Offeror and the date the employee left \*PORT AUTHORITY OF GUAM\*. Use Part B for Offeror Associates with Relatives, Immediate Family Members, or Members of the Household working for \*PORT AUTHORITY OF GUAM\* that have had or will have involvement with this Procurement or Contract.

<b>Part A: Employees that left *PORT AUTHORITY OF GUAM* in the last year.</b>			
<b>Employee Name/Signature</b>	<b>Job Performed for *PORT AUTHORITY OF GUAM*</b>	<b>Current Role with Offeror</b>	<b>Date left *PORT AUTHORITY OF GUAM*</b>
Name: _____ Sign: _____ <ul style="list-style-type: none"> <li>• Involved with this Procurement on behalf of *PORT AUTHORITY OF GUAM*?  <b>No</b> <input type="checkbox"/>    <b>Yes</b> <input type="checkbox"/></li> <li>• Involved with Proposal development for this Procurement? <b>No</b> <input type="checkbox"/> <b>Yes</b> <input type="checkbox"/></li> </ul>			
Name: _____ Sign: _____ <ul style="list-style-type: none"> <li>• Involved with this Procurement on behalf of *PORT AUTHORITY OF GUAM*?  <b>No</b> <input type="checkbox"/>    <b>Yes</b> <input type="checkbox"/></li> <li>• Involved with Proposal development for this Procurement? <b>No</b> <input type="checkbox"/> <b>Yes</b> <input type="checkbox"/></li> </ul>			
Name: _____ Sign: _____ <ul style="list-style-type: none"> <li>• Involved with this Procurement on behalf of *PORT AUTHORITY OF GUAM*?  <b>No</b> <input type="checkbox"/>    <b>Yes</b> <input type="checkbox"/></li> <li>• Involved with Proposal development for this Procurement? <b>No</b> <input type="checkbox"/> <b>Yes</b> <input type="checkbox"/></li> </ul>			
<b>Part B: Identify Associates of the Offeror that are Relatives, Immediate Family Members, or Members of the Household of *PORT AUTHORITY OF GUAM* employees currently working for *PORT AUTHORITY OF GUAM*, if the *PORT AUTHORITY OF GUAM* employee had or will have any involvement with this Procurement or Contract.</b>			
<b>Offeror Associate's Name</b>	<b>Name and Relationship of Relative, Immediate Family Member, or Member of Household Employed at *PORT AUTHORITY OF GUAM*</b>	<b>Role at *PORT AUTHORITY OF GUAM*</b>	<b>*PORT AUTHORITY OF GUAM* employee's Role with this Procurement</b>

(Make copies of this form as needed to list additional employees.)

## INSTRUCTIONS FOR COMPLETION OF SF-LLL, DISCLOSURE OF LOBBYING ACTIVITIES

This disclosure form shall be completed by the reporting entity, whether subawardee or prime Federal recipient, at the initiation or receipt of a covered Federal action, or a material change to a previous filing, pursuant to title 31 U.S.C. section 1352. The filing of a form is required for each payment or agreement to make payment to any lobbying entity for influencing or attempting to influence an officer or employee of the Port Authority of Guam, a Member of Congress, an officer or employee of Congress, or an employee of a Member of Congress in connection with a covered Federal action. Complete all items that apply for both the initial filing and material change report. Refer to the implementing guidance published by the Office of Management and Budget for additional information.

1. Identify the type of covered Federal action for which lobbying activity is and/or has been secured to influence the outcome of a covered Federal action.
2. Identify the status of the covered Federal action.
3. Identify the appropriate classification of this report. If this is a followup report caused by a material change to the information previously reported, enter the year and quarter in which the change occurred. Enter the date of the last previously submitted report by this reporting entity for this covered Federal action.
4. Enter the full name, address, city, State and zip code of the reporting entity. Include Congressional District, if known. Check the appropriate classification of the reporting entity that designates if it is, or expects to be, a prime or subaward recipient. Identify the tier of the subawardee, e.g., the first subawardee of the prime is the 1st tier. Subawards include but are not limited to subcontracts, subgrants and contract awards under grants.
5. If the organization filing the report in item 4 checks "Subawardee," then enter the full name, address, city, State and zip code of the prime Federal recipient. Include Congressional District, if known.
6. Enter the name of the Port Authority of Guam making the award or loan commitment. Include at least one organizational level below the Port Authority of Guam name, if known. For example, Department of Transportation, United States Coast Guard.
7. Enter the Federal program name or description for the covered Federal action (item 1). If known, enter the full Catalog of Federal Domestic Assistance (CFDA) number for grants, cooperative agreements, loans, and loan commitments.
8. Enter the most appropriate Federal identifying number available for the Federal action identified in item 1 (e.g., Request for Proposal (RFP) number; Invitations for Bid (IFB) number; grant announcement number; the contract, grant, or loan award number; the application/proposal control number assigned by the Federal Port Authority of Guam). Included prefixes, e.g., "RFP-DE-90-001."
9. For a covered Federal action where there has been an award or loan commitment by the Port Authority of Guam, enter the Federal amount of the award/loan commitment for the prime entity identified in item 4 or 5.
10. (a) Enter the full name, address, city, State and zip code of the lobbying registrant under the Lobbying Disclosure Act of 1995 engaged by the reporting entity identified in item 4 to influence the covered Federal action.  
  
(b) Enter the full names of the individual(s) performing services, and include full address if different from 10(a). Enter Last Name, First Name, and Middle Initial (MI).
11. The certifying official shall sign and date the form, print his/her name, title, and telephone number.

**Disclosure of Lobbying Activities**

Complete this form to disclose lobbying activities pursuant to 31 U.S.C. 1352  
(See reverse for public burden disclosure)

<p><b>1. Type of Federal Action:</b>                  a. contract                  _____ b. grant                  c. cooperative agreement                  d. loan                  e. loan guarantee                  f. loan insurance</p>	<p><b>2. Status of Federal Action:</b>                  a.                  bid/offer/application                  _____ b. initial award                  c. post-award</p>	<p><b>3. Report Type:</b>                  a. initial filing                  _____ b. material change</p> <p><b>For material change only:</b>                  Year _____ quarter _____                  Date of last report _____</p>
<p><b>4. Name and Address of Reporting Entity:</b>                  _____ Prime      _____ Subawardee                  Tier _____, if Known:</p> <p><b>Congressional District, if known:</b></p>		<p><b>5. If Reporting Entity in No. 4 is Subawardee,</b>                  Enter Name and Address of Prime:</p> <p><b>Congressional District, if known:</b></p>
<p><b>6. Federal Department/Port Authority of Guam:</b></p>	<p><b>7. Federal Program Name/Description:</b></p> <p>CFDA Number, if applicable: _____</p>	
<p><b>8. Federal Action Number, if known:</b></p>	<p><b>9. Award Amount, if known:</b>                  \$</p>	
<p><b>10. a. Name and Address of Lobbying Registrant</b>                  (if individual, last name, first name, MI):</p>	<p><b>b. Individuals Performing Services (including address if different from No. 10a)</b>                  (last name, first name, MI):</p>	
<p><b>11. Information requested through this form is authorized by title 31 U.S.C. section 1352. This disclosure of lobbying activities is a material representation of fact upon which reliance was placed by the tier above when this transaction was made or entered into. This disclosure is required pursuant to 31 U.S.C. 1352. This information will be reported to the Congress semi-annually and will be available for public inspection. Any person who fails to file the required disclosure shall be subject to a civil penalty of not less than \$10,000 and not more than \$100,000 for each such failure.</b></p>	<p><b>Signature:</b>                  _____</p> <p><b>Print Name:</b> _____</p> <p><b>Title:</b> _____</p> <p><b>Telephone No.:</b> _____ <b>Date:</b> _____</p>	
<p><b>Federal Use Only</b></p>	<p>Authorized for Local Reproduction                  Standard Form - LLL (Rev. 7-97)</p>	

**GOVERNMENT OF GUAM  
GENERAL TERMS AND CONDITIONS**

SEALED BID SOLICITATION AND AWARD

**Only those Boxes checked below are applicable to this bid.**

- [X] 1. **AUTHORITY:** This solicitation is issued subject to all the provision of the Guam Procurement Act (5GCA, Chapter 5) and the Guam Procurement Regulations (copies of both are available at the Office of the Complier of laws, Department of Law, copies available for inspection at the PORT AUTHORITY OF GUAM). It requires all parties involved in the Preparation, negotiation, performance, or administration of contracts to act in good faith.
- [X] 2. **GENERAL INTENTION:** Unless otherwise specified, it is the declared and acknowledged intention and meaning of these General Terms and conditions for the bidder to provide the Government of Guam (Government) with specified services or with materials, supplies or equipment completely assembled and ready for use.
- [X] 3. **TAXES:** Bidders are cautioned that they are subject to Guam Income Taxes as well as all other taxes on Guam Transactions. Specific information on taxes may be obtained from the Director of Revenue and Taxation.

**WITHHOLDING ASSESSMENT FEE:**

All agencies, to include autonomous agencies, of the government of Guam shall ensure that all Requests for Proposals (RFP) and Invitations for Bid (IFB) must include the notification to potential offerors that the award and issuance of a contract to provide the professional services is subject to the withholding **assessment** fee for contracts awarded to persons without a valid Guam business license, as follows: all procurements of professional services are subject to a withholding **assessment** fee for non-resident persons or companies without a valid Guam Business License, which is equal to four percent (4%) of the total dollar value of any contract awarded for all government of Guam contracts for any professional services provided by a non-resident person or company residing outside of Guam, as a cost of doing business with the government of Guam, in accordance with 11 GCA § 71114 (P.L. 33-166)."

- [X] 4. **LICENSING:** Bidders are cautioned that the Government will not consider for award any offer submitted by a bidder who has not complied with the Guam Licensing Law. Specific information on licenses may be obtained from the Director of Revenue and Taxation.
- [X] 5. **NO LOCAL PROCUREMENT PREFERENCE:** There is no geographical preference for this IFB in compliance with 2 CFR § 200.319(c) and the terms and conditions of MARAD FY2022 American Marine Highway (AMH) Grant No.: 693JF72340007; however, no specification, term, condition, or qualification of this IFB shall exclude any Offeror from consideration on the basis of Guam-only experience provided that the experience of such Offeror is otherwise responsive to the solicitation, in accordance with the requirements of 5 GCA § 5008(e).
- [X] 6. **COMPLIANCE WITH SPECIFICATIONS AND OTHER SOLICITATION REQUIREMENTS:** Bidders shall comply with all specifications and other requirements of the Solicitation.

- [X] 8. **"ALL OR NONE" BIDS:** NOTE: By checking this item, the Government is requesting all of the bid items to be bided or none at all.  
The Government will not award on an itemized basis.

- [X] 9. **INDEPENDENT PRICE DETERMINATION:** The bidder, upon signing the Invitation for Bid, certifies that the prices in his bid were derived at without collusion, and acknowledge that collusion and anti-competitive practices are prohibited by law. Violations will be subject to the provision of Section 5651 of that of the Guam Procurement Act. Other existing civil, criminal or administrative remedies are not impaired and may be in addition to the remedies in Section 5651 of the Government code.

- [X] 10. **BIDDER'S PRICE:** The Government will consider not more than one (1) (base bid) item prices and the bidder shall explain fully each price if supplies, materials, equipment, and/or specified services offered comply with specifications and the products origin. Where basic bid meets the minimum required specification, cost and other factors will be considered.
- [X] 11. **BID ENVELOPE:** Envelope shall be sealed and marked with the bidder's name, bid number, time, date. Bid may be submitted before the deadline and stamped received via mail, but must be prior to bid opening date and time. If received after, it shall be stamped with the date and time was received, and returned as rejected,
- [X] 12. **BID GUARANTEE REQUIREMENT:** Bidder is required to submit a Bid Guarantee Bond or standby irrevocable Letter of Credit or Certified Check or Cashier's Check in the same bid envelope to be held by the Government pending award. The Bid Guarantee Bond, Letter of Credit, Certified Check or Cashier's Check must be issued by any local surety or banking institution licensed to do business on Guam and made payable to the Treasure of Guam in the amount of fifteen percent (15%) of his highest total bid offer. The Bid Bond must be submitted on Government Standard Form BB-1 (copy enclosed). Personal Checks will not be accepted as Bid Guarantee. If a successful Bidder (contractor) withdraws from the bid or fails to enter into contract within the prescribed time, such Bid guarantee will be forfeited to the Government of Guam. Bids will be disqualified if not accompanied by Bid Bond, Letter of Credit, Certified Check or Cashier's check. Bidder must include in his/her bid, valid copies of a Power of Attorney from the Surety and a Certificate of Authority from the Government of Guam to show proof that the surety company named on the bond instrument is authorized by the Government of Guam and qualified to do business on Guam. For detailed information on bonding matters, contact the Department of Revenue and Taxation. Failure to submit a valid Power of Attorney and Certificate of Authority on the surety is cause for rejection of bid. **Pursuant to 5 GCA § 5212, all competitive sealed bidding for the procurement of supplies or services exceeding \$25,000.00 a 15% Bid Security of the total bid price must accompany the bid package. The bid bond, Letter of Credit, Certified Check or Cashier's Check will serve as Bid Security for this procurement.**
- [X]13. **PERFORMANCE GUARANTEE:** Bidders who are awarded a contract under this solicitation, guarantee that goods will be delivered or required services performed within the time specified. Failure to perform the contract in a satisfactory manner may be cause for suspension or debarment from doing business with the Government of Guam. In addition, the Government will hold the Vendor liable and will enforce the requirements as set forth in Section 40 of these General Terms and Conditions.
- [X] 14. **SURETY BONDS:** Bid and Bid Bonds coverage must be signed or countersigned in Guam by a foreign or alien surety's resident general agent. The surety must be an Insurance Company, authorized by the government of Guam and qualified to do business in Guam. Bids will be disqualified if the Surety Company does not have a valid Certificate of Authority from the Government of Guam to conduct business in Guam.
- [X] 15. **COMPETENCY OF BIDDERS:** Bids will be considered only from such bidders who, in the opinion of the Government, can show evidence of their ability, experience, equipment, and facilities to render satisfactory service.
- [X] 16. **DETERMINATION OF RESPONSIBILITY OF BIDDERS:** The GENERAL MANAGER reserves the right for securing from Bidders information to determine whether or not they are responsible and to inspect plant site, place of business; and supplies and services as necessary to determine their responsibility in accordance with Section 15 of these General Terms and Conditions.  
(2 GAR, Div. 4 § 3116)
- [X] 17. **STANDARD FOR DETERMINATION OF LOWEST RESPONSIBLE BIDDER:**  
In determining the lowest responsible offer, the GENERAL MANAGER shall be guided by the following:
- a) Price of items offered.
  - b) The ability, capacity, and skill of the Bidder to perform.
  - c) Whether the Bidder can perform promptly or within the specified time.
  - d) The quality of performance of the Bidder with regards to awards previously made to him.
  - e) The previous and existing compliance by the Bidder with laws and regulations relative to procurement.
  - f) The sufficiency of the financial resources and ability of the Bidder to perform.
  - g) The ability of the bidder to provide future maintenance and services for the subject of the award.



h) The compliance with all of the conditions to the Solicitation.

- [X] 18. **TIE BIDS:** If the bids are for the same unit price or total amount in the whole or in part, the GENERAL MANAGER will determine award based on 2 GAR, Div. 4, § 3109(o) (2) or to reject all such bids.
- [X] 19. **BRAND NAMES:** Any reference in the Solicitation to manufacturer's Brand Names and number is due to lack of a satisfactory specification of commodity description. Reference is intended to be descriptive, but not restrictive and for the sole purpose of indicating prospective bidders a description of the article or services that will be satisfactory. Bids on comparable items will be considered provided the bidder clearly states in his bid the exact articles he is offering and how it differs from the original specification.
- [X] 20. **DESCRIPTIVE LITERATURE:** Descriptive literature(s) as specified in this solicitation must be furnished as a part of the bid and must be received at the date and time set for opening Bids. The literature furnished must clearly identify the item(s) in the Bid. The descriptive literature is required to establish, for the purpose of evaluation and award, details of the product(s) the bidder proposes to furnish including design, materials, components, performance characteristics, methods of manufacture, construction, assembly or other characteristics which are considered appropriate. Rejection of the Bid will be required if the descriptive literature(s) do not show that the product(s) offered conform(s) to the specifications and other requirements of this solicitation. Failure to furnish the descriptive literature(s) by the time specified in the Solicitation will require rejection of the bid.
- [ ] 21. **SAMPLES:** Sample(s) of item(s) as specified in this solicitation must be furnished as a part of the bid and must be received at the date and time set for opening Bids. The sample(s) should represent exactly what the bidder proposes to furnish and will be used to determine if the item(s) offered complies with the specifications. Rejection of the Bid will be required if the sample(s) do not show that the product(s) offered conform(s) to the specifications and other requirements of this solicitation. Failure to furnish the sample(s) by the time specified in the Solicitation will require rejection of the Bid.
- [ ] 22. **LABORATORY TEST:** Successful bidder is required to accompany delivery of his goods with a Laboratory Test Report indicating that the product he is furnishing the Government meets with the specifications. This report is on the bidder's account and must be from a certified Testing Association.
- [X] 23. **AWARD, CANCELLATION, & REJECTION:** Award shall be made to the lowest responsible and responsive bidder, whose bid is determined to be the most advantageous to the Government, taking into consideration the evaluation factors set forth in this solicitation. No other factors or criteria shall be used in the evaluation. The right is reserved as the interest of the Government may require to waive any minor irregularity in bid received. The GENERAL MANAGER shall have the authority to award, cancel, or reject bids, in whole or in part for any one or more items if he determines it is in the public interest. Award issued to the lowest responsible bidder within the specified time for acceptance as indicated in the solicitation, results in a bidding contract without further action by either party. In case of an error in the extension of prices, unit price will govern. It is the policy of the Government to award contracts to qualified local bidders. The Government reserves the right to increase or decrease the quantity of the items for award and make additional awards for the same type items and the vendor agrees to such modifications and additional awards based on the bid prices for a period of thirty (30) days after original award. No award shall be made under this solicitation which shall require advance payment or irrevocable letter of credit from the government (2 GAR, Div.4 §1103).
- [ ] 24. **MARKING:** Each outside container shall be marked with the Purchase Order number, item number, brief item description and quantity. Letter marking shall not be less than 3/4" in height.
- [X] 25. **SCHEDULE FOR DELIVERY:** Successful bidder shall notify the PORT AUTHORITY OF GUAM, Telephone Nos. 477-5931, at least twenty-four (24) hours before delivery of any item under this solicitation.
- [ ] 26. **BILL OF SALE:** Successful supplier shall render Bills of Sale for each item delivered under this contract. Failure to comply with this requirement will result in rejection of delivery. The Bill of Sale must accompany the items delivered but will not be considered as an invoice for payment. Supplier shall bill the Government in accordance with billing instructions as indicated on the Purchase Order.
- [ ] 26. **MANUFACTURER'S CERTIFICATE:** Successful bidder is required, upon delivery of any item under this contract, to furnish a certificate from the manufacturer indication that the goods meet the

specifications. Failure to comply with this request will result in rejection of delivery payment. Supplier shall bill the Government in accordance with billing instructions as indicated on the Purchase Order.

[X] 27. **INSPECTION:** All supplies, materials, equipment, or services delivered under this contract shall be subject to the inspection and/or test conducted by the Government at destination. If in any case the supplies, materials, equipment, or services are found to be defective in material, workmanship, performance, or otherwise do not conform with the specifications, the Government shall have the right to reject the items or require that they be corrected. The number of days required for correction will be determined by the Government.

[ ] 28. **MOTOR VEHICLE SAFETY REQUIREMENTS:** The Government will only consider Bids on motor vehicles which comply with the requirements of the National Traffic and Motor Vehicle safety Act of 1966 (Public Law 89-563) and Clean Air Act as amended (Public Law 88-206), that are applicable to Guam. Bidders shall state if the equipment offered comply with these aforementioned Federal Laws.

[ ] 29. **SAFETY INSPECTION:** All motor vehicles delivered under this contract must pass the Government of Guam Vehicle Inspection before delivery at destination.

[X] 30. **GUARANTEE:**

**a) Guarantee of Vehicle Type of Equipment:**

The successful bidder shall guarantee vehicular type of equipment offered against defective parts, workmanship, and performance, for a period of not less than one (1) year after date of receipt of equipment. Bidder shall also provide service to the equipment for at least one (1) year. Service to be provided shall include, but will not be limited to tune ups (change of spark plugs, contact points and condensers) and lubrication (change of engine and transmission oil). All parts and labor shall be at the expense of the bidder. All parts found defective and not caused by misuse, negligence or accident within the guarantee period shall be repaired, replaced, or adjusted within six (6) working days after notice from the Government and without cost to the Government. Vehicular type of equipment as used in this context shall include equipment used for transportation as differentiated from tractors, backhoes, etc.

**b) Guarantee of Other Type of Equipment:**

The successful bidder shall guarantee all other types of equipment offered, except those mentioned in 30a, above, against defective parts, workmanship, and performance for a period of not less than three (3) months after date of receipt of equipment. Bidder shall also provide service to the equipment for at least three (3) months. All parts found defective within that period shall be repaired or replaced by the Contractor without cost to the Government. Repairs, adjustments or replacements of defective parts shall be completed by the contractor within six (6) working days after notice from the Government.

**(c) Compliance with this Section is a condition of this Bid.**

[X] 31. **REPRESENTATION REGARDING ETHICS IN PUBLIC PROCUREMENT:** The bidder or contractor represents that it has not knowingly influenced and promises that it will not knowingly influence a Government employee to breach any of the ethical standards and represents that it has not violated, is not violating, and promises that it will not violate the prohibition against gratuities and kickbacks set forth on Chapter 11 (Ethics in Public Contracting) of the Guam Procurement Act and in Chapter 11 of the Guam Procurement Regulations.

[X] 32. **REPRESENTATION REGARDING CONTINGENT FEES:** The contractor represents that it has not retained a person to solicit or secure a Government contract upon an agreement or understanding for a commission, percentage, brokerage, or contingent fee, except for retention of bona fide employees or bona fide established commercial selling agencies for the purpose of securing business (GPR Section 11-207).

[X] 33. **EQUAL EMPLOYMENT OPPORTUNITY:** Contractors shall not discriminate against any employee or applicant of employment because of race, color, religion, sex, or national origin. The contractor will take affirmative action to ensure that employees are treated equally during employment without regards to their race, color, religion, sex, or national origin.

- [X] 34. **COMPLIANCE WITH LAWS:** Bidders awarded a contract under this Solicitation shall comply with the applicable standard, provisions, and stipulations of all pertinent Federal and/or local laws, rules, and regulations relative to the performance of this contract and the furnishing of goods.
- [ ] 35. **CHANGE ORDER:** Any order issued relative to awards made under this solicitation will be subject to and in accordance with the provisions of Section 6-101-03.1 of the Guam Procurement Regulations.
- [X] 36. **STOP WORK ORDER:** Any stop work order issued relative to awards made under this solicitation will be subject to and in accordance with the provisions of Section 6-101-04.1 of the Guam Procurement Regulations.
- [X] 37. **CANCELLATION OF INVITATION FOR BIDS OR REQUEST FOR PROPOSALS:** Any Invitation for Bid may be cancelled, or any or all bids or proposals may be rejected in whole or in part as may be specified in the solicitation, when it is in the best interests of the Territory in accordance with regulations promulgated by the Policy Office. The reasons therefor shall be made part of the contract file.

Contract will be cancelled if funds not appropriated or insufficient, and that government will timely inform contractor. 2 GAR, Div.4 §3121(e) (1) (C) and 2 GAR, Div.4 § 3121(e)(1)(D).

If cancelled, contractor will be reimbursed unamortized reasonably incurred non-recurring costs. 2 GAR, Div.4 § 3121(e) (1) (G).

- [X] 38. **TIME FOR COMPLETION:** It is hereby understood and mutually agreed by and between the contractor and the Government that the time for delivery to final destination or the timely performance of certain services is an essential condition of this contract. If the contractor refuses or fails to perform any of the provisions of this contract within the time specified in the Purchase Order (from the date Purchase Order is acknowledged by vendor), then the contractor is in default. Defaults will be treated subject to and in accordance with the provisions of 2 GAR, Div. 4 § 6101(8)
- [X] 39. **JUSTIFICATION OF DELAY:** Bidders who are awarded contracts under this Solicitation, guarantee that the goods will be delivered to their destination or required services rendered within the time specified. If the bidder is not able to meet the specified delivery date, he is required to notify the GENERAL MANAGER of such delay. Notification shall be in writing and shall be received by the GENERAL MANAGER at least twenty-four (24) hours before the specified delivery date. Notification of delay shall include an explanation of the causes and reasons for the delay including statement(s) from supplier or shipping company causing the delay. The Government reserves the right to reject delay justification if, in the opinion of the GENERAL MANAGER, such justification is not adequate.
- [X] 40. **SERVICE-DISABLED VETERAN OWNED BUSINESS PREFERENCE:** Bidding is subject to the policy in favor of Service-Disabled Veteran Owned Business as defined in 5 GCA sections 5011 and 5012.
- [X] 41. **LIQUIDATED DAMAGES:** When the contractor is given notice of delay or nonperformance as specified in Paragraph 1 (Default) of the Termination for Default Clause of this contract and fails to cure in the time specified, the contractor shall be liable for damages for delay in the amount of one-fourth of one percent (1%) of outstanding order per calendar day from date set for cure until either the territory reasonable obtains similar supplies or services if the contractor is terminated for default, or until the contractor provides the supplies or services if the contractor is not terminated for default. To the extent that the contractor's delay or nonperformance is excused under Paragraph 40 (Excuse for Nonperformance or Delayed Performance) of the Termination for Default Clause of this contract, liquidated damages shall not be due the territory. The contractor remains liable for damages caused other than by delay. **2 GAR, Div. 4 §6101(d).**
- [X] 42. **PHYSICAL LIABILITY:** If it becomes necessary for the Vendor, either as principal, agent or employee, to enter upon the premises or property of the Government of Guam in order to construct, erect, inspect, make delivery or remove property hereunder, the Vendor hereby covenants and agrees to take, use, provide and make all proper, necessary and sufficient precautions, safeguards and protections against the occurrence of any accidents, injuries or damages to any person or property during the progress of the work herein covered, and to be responsible for, and to indemnify and save harmless the Government of Guam from the payment of all sums of money by reason of all or any such accidents, injuries or damages that may occur upon or about such work, and fines, penalties and loss incurred for or by reasons of the violations of any territorial ordinance, regulations, or the laws of Guam or the United States, while the work is in progress. Contractor will carry insurance to indemnify the Government of

Guam against any claim for loss, damage or injury to property or persons arising out of the performance of the Contractor or his employees and agents of the services covered by the contract and the use, misuse or failure of any equipment used by the contractor or his employees or agents, and shall provide certificates of such insurance to the Government of Guam when required.

[X] 43. **INSURANCE COVERAGE REQUIRED:** The amount of insurance required shall be determined by the Port's General Manager depending upon the type of activity conducted, or to be conducted by the owners or operators of vehicles entering the Port's facilities other service providers accessing on foot.

- A. Commercial General Liability including Broad Form Property Damage and Contractual Liability \$1,000,000.00 combined single limit of liability
- B. Worker's Compensation – Statutory
- C. Automobile Liability - \$1,000,000.00 combined single limit of liability

Insurance Company: The insurance coverage(s) must be issued by those insurance companies who are licensed to do business on Guam, as determined by the Insurance Commissioner of the Department of Revenue and Taxation.

Additional Insurance Provision: All Commercial insurance policies possessed by owners or operators of vehicles entering or using the Port's facilities and/or grounds must name the Port as an additional Insured in their policies and specify that the Port shall be given at least thirty (30 days' prior written notice of any cancellation, material change or reduction in coverage.

Proof of Insurance: An Insurance Certificate must be issued listing all the vehicles, equipment, trucks covered under the insurance policy and filed with the Port Police Division. The insurance should include;

Name of the Insured (The Port must be shown as an Additional Insured on all Commercial insurance policies)

- Policy Number
- Effective Date of Policy
- Limits of Insurance
- Description of Coverage Provided; and
- Name of Issuing Company

A certified copy of the Insurance Certificate must be carried in each vehicle, equipment and/or truck entering the Port facilities. This proof of insurance must be provided to the Port Police Division on an annual basis at least ten (10) days before the insurance policy expires.

Notice of Loss: In the event a Port tenant or user is involved in an accident within the Port's facilities or while on Routes 11A or 11B (Cabras Highway) and results in bodily injury or property damage, the Port Police Division must be immediately notified.

Workers' Compensation: All business entities entering or using the Port's facilities must also possess Workers' Compensation Insurance coverage as prescribed by Guam laws and copies of such Certificate of Insurance are to be filed with the Port Police Division. Each certification shall specify that the Port shall be given at least thirty (30) days prior written notice of any cancellation, material change or reduction in coverage.

Interchange Agreement: In lieu of fulfilling the maximum the maximum insurance requirements listed herein, the Port user must provide to the Port a current Interchange Agreement. The primary company must have fulfilled the maximum insurance requirements listed above. The Interchange Agreement must specifically state and name the Port user as additional insured and the duration of coverage. The Port must be notified thirty (30) days prior written notice of any cancellation, materials change or reduction in coverage.

[X] 44. Contract will be cancelled if funds not appropriated or insufficient, and that government will timely inform contractor. 2 GAR, Div. 4 §3121(e) (1)(C) and 2 GAR, Div. 4 § 3121(e) (1) (D)

[ ] 45. If cancelled, contractor will be reimbursed unamortized reasonably incurred non-recurring costs. 2 GAR, Div. 4 §3121(e) (1) (G)

[X] 46. **CONTACT FOR CONTRACT ADMINISTRATION:** If your firm receives a contract as a result of this Solicitation, please designate a person whom we may contact for prompt administration.

- [X] 47. **WOMEN-OWNED BUSINESS PREFERENCE:** Bidding is subject to the policy in favor of Women-Owned Businesses pursuant to *"The Support for Women-Owned Business Act"* enacted by Public Law No. 36-26 and codified in 5 GCA section 5013.
- [X] 48. **FEDERAL GSA SCHEDULES:** This IFB is federally funded under MARAD FY2022 American Marine Highway (AMH) Grant No.: 693JF72340007. The Port Authority of Guam is accepting Federal GSA pricing inclusive with shipping cost to Guam. If the bid pricing existing on the Federal GSA website from a qualified vendor for qualifying items on the date of opening of the bids, plus the confirmed price of shipping costs to Guam, confirmed after the opening of the bids, is the lowest price, then the contract will be awarded to that vendor.
- [X] 49. **MULTI-TERM CONTRACT:** (A) the amount of supplies or services required for the proposed contract period; (B) that a unit price shall be given for each supply or service, and that such unit prices shall be the same throughout the contract (except to the extent price adjustments may be provided in the solicitation and resulting contract); (C) that the multi-term contract will be cancelled only if funds are not appropriated or otherwise made available to support continuation of performance in any fiscal period succeeding the first; however, this does not affect either the territory's rights or the contractor's rights under any termination clause in the contract; (D) that the Procurement Officer must notify the contractor on a timely basis that the funds are, or are not, available for the continuation of the contract for each succeeding fiscal period; (E) whether bidders or offerors may submit prices for: (i) the first fiscal period only; (ii) the entire time of performance only; or (iii) both the first fiscal period and the entire time of performance; (F) that a multi-term contract may be awarded and how award will be determined including, if prices for the first fiscal period and entire time of performance are submitted, how such prices will be compared; and in the event that funds are not available for any succeeding fiscal period, the remainder of such contract shall be cancelled and the contractor shall be reimbursed the reasonable value of any nonrecurring costs incurred but not amortized in the price of the supplies delivered or services performed under the contract.

Name: \_\_\_\_\_ Title: \_\_\_\_\_

Address: \_\_\_\_\_ Telephone: \_\_\_\_\_

GOVERNMENT OF GUAM

SEALED BID SOLICITATION INSTRUCTIONS

1. **BID FORMS:** Each bidder shall be provided with one (1) set of solicitation forms. Additional hard copies may be provided upon request. Bidders requesting additional copies of said forms will be charged per page in accordance with 5 GCA § 10203 of the Government Code of Guam. All payments for this purpose shall be by cash, certified check or money order and shall be made payable to the PORT AUTHORITY OF GUAM (EO 86-24).
2. **PREPARATIONS OF BIDS:**
  - 2.0 Bidders are required to examine the drawings, specifications, schedule, and all instructions. Failure to do so will be at bidder's risk.
  - 2.1 Each bidder shall furnish the information required by the Solicitation. The bidder shall sign the Solicitation and print or type his name on the Schedule. Erasures or other changes must be initialed by the person signing the bid. Bids signed by an agent are to be accompanied by evidence of this authority unless such evidence has been previously furnished to the issuing office.
  - 2.2 Unit price for each unit offered shall be shown and such price shall include packing unless otherwise specified. A total shall be entered in the amount column of the Schedule for each item offered. In case of discrepancies between a unit price and extended price, the unit price will be presumed to be correct.
  - 2.3 Bids for supplies or services other than those specified will not be considered. Time, if stated as a number of days, means calendar days and will include Saturdays, Sundays, and holidays beginning the day after the issuance of a Notice to Proceed. Time stated ending on a Saturday, Sunday or Government of Guam legal holiday will end at the close of the next business day.
  - 2.4 No Entitlement To Preparation Costs – the bidder expressly waives any right it may have against the government for any expenses incurred in connection with the preparation of its bid.
3. **EXPLANATION TO BIDDERS:** Any explanation desired by a bidder regarding the meaning or interpretation of the Solicitation, drawings, specifications, etc., must be submitted in writing and with sufficient time allowed for a written reply to reach all bidders before the submission of their bids. Oral explanations or instructions given before the award of the contract will not be binding. Any information given to a prospective bidder concerning a Solicitation will be furnished to all prospective bidders in writing as an amendment to the Solicitation if such information would be prejudicial to informed bidders.
4. **ACKNOWLEDGEMENT OF AMENDMENTS TO SOLICITATIONS:** Receipt of an amendment to a Solicitation by a bidder must be acknowledged by signing an acknowledgement of receipt of the amendment. Such acknowledgement must be received prior to the hour and date specified for receipt of bids.
5. **SUBMISSION OF BIDS:**
  - a) Bids and modifications thereof shall be enclosed in sealed envelopes and addressed to the office specified in the Solicitation. The bidder shall show the hour and date specified in the Solicitation for receipt, the Solicitation number, and the name and address of the bidder on the face of the envelope.
  - b) Telegraphic or e-mailed bids will not be considered, all bidders must submit in a sealed envelope by or before the date and time bids are due. However, bids may be modified or withdrawn by written or telegraphic notice, provided such notice is received prior to the hour and date specified for receipt (see paragraph 6 of these instructions).
  - c) Samples of items, when required, must be submitted within the time specified, unless otherwise specified by the Government, at no expense to the Government. If not destroyed by

testing, samples will be returned at bidder's request and expense, unless otherwise specified by the Solicitation.

- d) Descriptive literature should be submitted as required on this solicitation. Descriptive literature will be examined or tested at the bidder's risk, and will not be deemed to vary any of the provisions of this solicitation.
6. **Multiple or Alternate Bids or Proposals:** At least one (1) multiple or alternate bid will be accepted. It must be marked on the packet as alternate and your base bid must be marked as primary, placed in separate sealed envelopes. Alternate bids shall only be considered for award if the bidder's primary bid is the lowest responsive and responsible bid.
7. **FAILURE TO SUBMIT BID:** If no bid is to be submitted, do not return the solicitation unless otherwise specified. A letter or postcard shall be sent to the issuing office advising whether future Solicitations for the type of supplies or services covered by this Solicitation are desired.
8. **LATE BID, LATE WITHDRAWALS, AND LATE MODIFICATIONS:**
  - a) Definition: Any bid received after the time and date set for receipt of bids is late. Any withdrawal or modification of a bid received after the time and date set for opening of bids at the place designated for opening is late (Guam Procurement Regulations 2 GAR, Div.4 §3109(k)).
  - b) Treatment: No late bid, late modification, or late withdrawal will be considered unless received before contract award, and the bid, modification, or withdrawal would have been timely but for the action or inaction of territorial personnel directly serving the procurement activity.
9. **DISCOUNTS:**
  - a) Notwithstanding the fact that prompt payment discounts may be offered, such offer will not be considered in evaluating bids for award unless otherwise specified in the Solicitation. However, offered discounts will be taken if payment is made within the discount period, even though not considered in the evaluation of bids.
  - b) In connection with any discount offered, time will be computed from date of delivery and acceptance of the supplies to the destination as indicated in the purchase order or contract. Payment is deemed to be made for the purpose of earning the discount on the date of mailing of the Government check.
9. **GOVERNMENT FURNISHED PROPERTY:** No material, labor or facilities will be furnished by the Government unless otherwise provided for in the Solicitation.
10. **SELLER' INVOICES:** Invoices shall be prepared and submitted in quadruplicate (one copy shall be marked "original") unless otherwise specified. Invoices shall be "certified true and correct" and shall contain the following information: Contract and order number (if any), item numbers, description of supplies or services, sizes, quantities, unit prices, and extended total. Bill of lading number and weight of shipment will be shown for shipments made on Government bills of lading.
11. **RECEIPT, OPENING AND RECORDING OF BIDS:** Bids and modifications shall be publicly opened in the presence of one or more witnesses, at the time, date, and place designated in the Invitation for Bids. The name of each bidder, the bid price, and such other information as is deemed appropriate by the Procurement Officer, shall be read aloud and recorded, or otherwise made available. The names and addresses of required witnesses shall be recorded at the opening. The opened bids shall be available for public inspection except to the extent the bidder designates trade secrets or other proprietary data to be confidential as set forth in accordance with Section 12, below. Material so designated shall accompany the bid and shall be readily separable from the bid in order to facilitate public inspection of the non-confidential portion of the bid. Prices, makes and models or catalogue numbers of the items offered, deliveries, and terms of payment shall be publicly available at the time of bid opening regardless of any designation to the contrary (Guam Procurement Regulations 2 GAR, Div.4 §3109(k)).
12. **CONFIDENTIAL DATA:** If a bidder considers any information submitted in its bid to be confidential, the bidder

must identify in writing to the Government those portions which it considers confidential, and must request in writing that those portions be kept confidential. Only trade secrets and proprietary data will be considered confidential. If there is a request for confidentiality, the Government will render a decision on the request as soon as practicable after bids are opened. The Government will advise any bidder requesting confidentiality, of the Government's decision in writing. If the Government does not agree with a bidder's request, then the Government will inform the bidder that it may lodge a protest regarding any part of the Government's decision by following the procedure for protests outlined in Chapter 9 of the Guam Procurement Regulations.

13. **PROHIBITION AGAINST GRATUITIES AND KICKBACKS:** With respect to this procurement and any other contract that bidder may have or wish to enter into with the Government, the bidder represents that he/she has not violated, is not violating, and promises that he will not violate the prohibition against gratuities and kickbacks set forth in the Guam Procurement Regulations.

14. **WAGE AND BENEFIT COMPLIANCE-CONTRACTORS PROVIDING SERVICES**

- a) Contractor with regard to all person its employs whose purpose in whole or in part is the direct delivery of services contracted for with the Government of Guam in this procurement, shall pay such employees in accordance with the Wage Determination for Guam and the Northern Marianas Islands issued and promulgated by the U.S. Department of Labor for such labor as is employed in the direct deliverance of deliverables to the government of Guam. 5 GCA § 5801 Contractor shall be responsible for flowing down this obligation to its subcontractors.
- b) The Wage Determination most recently issued by the U.S. Department of Labor at the time this Agreement was awarded to Contractor shall be used to determine wages and benefits which shall be paid to employees pursuant to this clause. 5 GCA § 5801
- c) Should any contract contain a renewal clause, then at the time of renewal adjustments there shall be stipulations contained in that contract for applying the Wage Determination, so that the Wage Determination promulgated by the U.S Department of Labor on a date most recent to the renewal date shall apply. 5 GCA § 5801
- d) In addition to the Wage Determination detailed above, health and similar benefits for employees having a minimum value as detailed in the Wage Determination issued and promulgated by the U.S. Department of Labor shall apply. Contractor shall pay a minimum of ten (10) paid holidays per annum per employee. 5 GCA § 5802
- e) Any violation of Contractor or its subcontractor's obligations of this section shall be investigated by the Guam Department of Labor and may include a monetary penalty assessment by the Guam Department of Labor of no less than One Hundred Dollars (\$100.00) per day, and no more than One Thousand Dollars (\$1,000.00) per day, until such time as a violation has been corrected, as well as the payment of all back wages and benefits due. 5 GCA § 5803
- f) In addition to any and all other breach of contract actions the Government of Guam may have under this procurement, in the event there is a violation in the process set forth in subsection (e) above, Contractor may be placed on probationary status by the GENERAL MANAGER of the General Service Agency, or its successor, for a period of one (1) year.

During the probationary status, a Contractor shall not be awarded any contract by any instrumentality of the Government of Guam. A Contractor who has been placed on probationary status, or has been assessed a monetary penalty pursuant to 5 G.C.A. Article 13 Title 5 may appeal such penalty or probationary status to the Superior Court of Guam. 5 GCA § 5804

- g) Contractor along with all proposed Offerors and submitter under this procurement were required to submit a Declaration of Compliance with Wage Determination laws as part of this procurement with a copy of the most recent Wage Determination for Guam and the Northern Marianas Islands issued and promulgated by the U.S. Department of Labor. 5 GCA §5805
- h) The applicable USDOL Wage Determination Rate Revision (as defined by subsections (b) and (c)) is to this Agreement. Contractor agrees to provide upon written request by the Government of Guam written certification of its compliance with its obligations as part of each invoice, along with the names of any employees, their positions, and detailed wage and benefits paid in keeping with this section. Additionally, upon request by Government of Guam the Contractor shall submit



source documents as to those individuals provide direct services in part or whole under this Agreement and its payments to them of such wages and benefits.

15. **ETHICAL STANDARDS**: With respect to this procurement and any other contract that the Contractor may have, or wish to enter into, with any government of Guam agency, the Contractor represents that it has not knowingly influenced, and promises that it will not knowingly influence, any government employee to breach any of the ethical standards set forth in the Guam Procurement Law and in any of the Guam Procurement Regulations.
16. **PROHIBITION AGAINST CONTINGENT FEES**: The Contractor represents that he has not retained any person or agency upon an agreement or understanding for a percentage, commission, brokerage, or other contingent arrangement, except for retention of bona fide employees or bona fide established commercial selling agencies, to solicit or secure this Agreement or any other contract with the government of Guam or its agencies.
17. **CONTRACTOR'S WARRANTY AS TO EMPLOYEES AND SEX OFFENSES**. *Reference 5 GCA 5253 (b)*  
Contractor warrants that no person providing services on behalf of the Contractor has been convicted of a sex offense under the provisions of Chapter 25 of Title 9 of GCA or an offense as defined in Article 2 of Chapter 28, Title 9 GCA, or an offense in another jurisdiction with, at a minimum, the same elements as such offenses, or who is listed on the Sex Offender Registry.

Contractor warrants that if any person providing services on behalf of Contractor is convicted of a sex offense under the provisions of Chapter 25 of Title 9 GCA, or an offense as defined in Article 2 of Chapter 28, Title 9 GCA, or an offense in another jurisdiction with, at a minimum, the same elements as such offenses, or who is listed on the Sex Offender Registry, that such person will be immediately removed from working at said agency and that the administrator of said agency be informed of such within twenty-four (24) hours of such conviction. Any contractor found in violation of this section, after notice from the Government of Guam, after notice from the contracting authority of such violation, shall within twenty-four (24) hours, take corrective action and shall report such action to the contracting authority. Failure to take corrective action with the stipulated period may result in the temporary suspension of the contract at the discretion of the Government of Guam.

18. **POLICY IN FAVOR OF SERVICE-DISABLED VETERAN OWNED BUSINESSES** P.L. 31-115 (September 20, 2011) 5 GCA § 5011 and § 5012 In the procurement of any supply or service, (except for professional services), if such supply or service is offered by a Service-Disabled Veteran Owned Business "SDVOB", as defined in 5 GCA § 5012, that is at least fifty one percent (51%) owned by service-disabled veteran(s), and if the supply or service is available within the period that is required for the procurement, and the price for the supply or service does not exceed one hundred five percent (105%) of the lowest bidder price, a preference shall be given to that SDVOB by the Government of Guam, and the supply or service shall be purchased from said SDVOB. This shall be in addition to any other procurement benefit the SDVOB may qualify for under Guam law. A business concern is a qualified SDVOB if: (a) the business concern is licensed to do business on Guam; (b) the business concern maintains its headquarters on Guam; (c) the business concern is at least fifty-one (51%) owned by a service-disabled veteran(s) who served in the active U.S. military service, was discharged or released under honorable conditions and whose disability is service-connected as demonstrated by a DD214, and certified by an award letter from the U.S. Department of Veterans Affairs; the DD214 and Disability award letter from U.S. Department of Veterans Affairs are submitted to the Government of Guam procuring agency for every service offered; and the service disabled veteran(s) owner(s) of the business concern has filed individual tax returns on Guam for a period of at least three (3) consecutive years.
19. **Policy In Favor of Women-Owned Businesses** (a) Notwithstanding any other provision of law, if any entity of the government of Guam or any entity expending governmental funds intends to procure any supply or service which is offered by a business concern that is at least fifty-one percent (51%) owned by women, that entity shall procure such supply or service from that business concern if the supply or service is available within the period required by the procuring entity and the price for the supply or service does not exceed one hundred five percent (105%) of the lowest price bidder, and shall be in addition to any other procurement benefit the women-owned business may qualify for under Guam law. The procuring entity shall determine the lowest price to the entity in the case of more than one (1) women-owned business, or a women-owned business and a service-disabled veteran owned business, who are competing for the same government contract. (b) Qualifications of a Women-Owned Business. A business concern is qualified under Subsection (a) of this Section if: (1) the business concern is licensed to do business on Guam; (2) the business concern maintains its headquarters on Guam; (3) the business

concern is at least fifty-one percent (51%) owned by women, who manage day-to-day operations and make long-term decisions; (4) the business concern is certified as a Women Owned Small Business (WOSB) or an Economically Disadvantaged Women-Owned Small Business (EDWOSB) by the U.S. Small Business Administration; and (5) the owner(s) of the business concern has (have) filed individual tax returns on Guam for a period of at least three (3) consecutive years.

ITEM NO.	DESCRIPTION	QUANTITY	UNIT	UNIT PRICE	EXTENSION
1.1	Telescopic Boom Lift, 180' Reach Full time 4WD	1	EA.	\$ _____	\$ _____

**GENERALS:** These specifications have been written, to describe minimum equipment and performance requirements to be supplied by the equipment manufacture bidding. Reasonable test may be conducted upon delivery before acceptance.

The successful bidder shall furnish all necessary and desirable information and instructions for the proper operation of the equipment.

The government reserves the right to accept and/or reject any and all bids, to waive any defects, Irregularities, or specification discrepancies and to award the bid as council deems to be in the best interest of the government.

**DISCREPANCIES**

**LISTED:** Should any bidder have deviations from these specifications in his bid and cannot meet every requirement of the specifications, he shall submit a letter and attach it to the bid, explaining the deviations, failure to do so will cause the bid to be rejected as being non-responsive.

**DELIVER:** The successful bidder shall deliver one (1) 180' Boom Lift each be new fully assembled and ready for operation to the Port Authority of Guam within 120 days.

**SPECIFICATIONS:**

**BIDDING AND OR REMARKS:**

**Engine:** 74 hp minimum,  
Diesel Engine  
Engine shutoff protection system  
(Low Oil Pressure, High Engine Temperature  
High Transmission Temperature) \_\_\_\_\_

**Fuel Type:** Diesel (Ultra Low Sulfur) Tier IV \_\_\_\_\_

**Fuel Tank:** The fuel tank furnished shall be Min. 50 gallon -----

**Platform reach:** 180ft & 10ft jib \_\_\_\_\_

**Platform Dimensions:**  
36 x 96 with railing & side entry -----

**Platform Capacity:**  
Unrestricted - 500 lbs \_\_\_\_\_  
Restricted - 750 lbs \_\_\_\_\_

**Platform Rotation:**  
160 degrees \_\_\_\_\_

**Swing:** 360 degrees continuous \_\_\_\_\_

**Steering:** Selectable Steering (ground level or platform) \_\_\_\_\_

**Axles:** Extendable front and rear -----

**Gauges:** Air, Fuel, Hour, Volt, Temp, and Oil \_\_\_\_\_

**Lights:** 2 Headlights in facing forward with protective guard,  
2 Headlights facing rear with protective guard.  
2 work lights on platform \_\_\_\_\_

**Tires:** Protector Lug Foam Filled tires \_\_\_\_\_

**Manlift Accessories:**  
Platform to be plumbed with air lines for use of pneumatic  
Tools \_\_\_\_\_  
Hostile Weather/Environment Kit \_\_\_\_\_  
AC plug/outlet in platform \_\_\_\_\_

**Accessories:** Standard manufacture accessories' to include  
 Horn - Electric \_\_\_\_\_  
 Amber strobe light, key switch "on position" activated. \_\_\_\_\_  
 Mounted 5 lbs. fire extinguisher on platform \_\_\_\_\_  
 1 set "Shop Type" repair manuals and complete \_\_\_\_\_  
 illustrated parts manual. \_\_\_\_\_  
 Diagnostic and Troubleshooting software \_\_\_\_\_  
 Owner/Operator manual for each equipment \_\_\_\_\_  
 Maintenance and Service manual for each equipment \_\_\_\_\_  
 Warranty booklet for each equipment \_\_\_\_\_  
 Recommended spare parts list \_\_\_\_\_  
 All fluids to the fullest level \_\_\_\_\_  
 Fuel tank to be loaded with 10 gallons of diesel. \_\_\_\_\_  
 Electronic Backup alarm \_\_\_\_\_  
 Engine shut-off protection system (Low Oil Pressure, \_\_\_\_\_  
 High Engine Temperature and High Transmission \_\_\_\_\_  
 Temperatures), \_\_\_\_\_  
 Reflective Conspicuity Tape \_\_\_\_\_  
 Electronic rust prevention system \_\_\_\_\_

**Receiving Date:** (Acceptance Date) will be Three (3) days after delivery Date, provided the Equipment is Delivered Completely Assembled and meets all specifications, terms and conditions of the bid requirements. \_\_\_\_\_

**Special Provision:** If parts catalog and maintenance repair comes in CD-ROM or Microfiche, bidder must supply to requesting agency. Bidder must still provide hard (book) copy to the requesting agency. \_\_\_\_\_

**Applicable Federal Laws And Regulations:** Buy American Act – 41 U.S.C § 8301-8305  
 Build America Buy America Act Certificate must be provide by the manufacture. \_\_\_\_\_

**Training:** Provide 2 sessions on pre inspection, post inspection and safe operational procedures for all operators, leaders, supervisors and dispatchers within Maintenance division. \_\_\_\_\_

**Warranty:** Manufacturers Standard Warranty, 1 year limited warranty. Service of one (1) year/ 2,000 hours, all parts, labor and oil disposal shall be included at "No Cost to the Government".

[ ] Yes, offer as requested. \_\_\_\_\_

[ ] No, Offer the following: \_\_\_\_\_

The manufacturer Warranty and Boucher shall be specified on items covered and provided in the bid packet. (Bid submission received without written warranty and Boucher as specified will be rejected).

[ ] Yes, offer as requested. \_\_\_\_\_

[ ] No, Offer the following: \_\_\_\_\_

The successful bidder shall provide technical assistance and warranty administration without any cost to "The Port Authority of Guam"

Yes, offer as requested. \_\_\_\_\_

No, Offer the following: \_\_\_\_\_

The successful bidder shall provide service, such as to determine deficiency, repair or adjustment of the equipment on government premises or transfer the equipment to the shop where the repair should be done, at anytime within the warranty period and at "No cost to the Government". When the equipment is down for warranty repair(s) and remain in shop for a certain period awaiting part(s) and or material(s), the total down-time period shall be extended to the service and warranty period.

Yes, offer as requested. \_\_\_\_\_

No, Offer the following: \_\_\_\_\_

The manufacture shall have a local authorized dealer who can provide factory trained service technician(s). Bidder shall provide certification of factory trained technician(s) for the above equipments be purchased during commissioning. Failure to provided will result as "Unacceptable".

Yes, offer as requested. \_\_\_\_\_

No, Offer the following: \_\_\_\_\_

Provide Complete Familiarization Training to Port Representatives on maintenance of Mechanical, Electrical and Hydraulic systems on units by manufacturer. All costs Associated with training (airfare, lodging and transportation) are to be included At no cost to the Government of Guam.

Yes, offer as requested. \_\_\_\_\_

No, Offer the following: \_\_\_\_\_

**This project is funded under the Fiscal Year 2022 America's Marine Highway (AMH) Program Grant No.: 693JF72340007**

**\_\_\_ Certification requirements for procurement of steel, iron, construction materials, or manufactured products.**

If steel, iron, construction materials, or manufactured products (as defined in § 70914(a) of the Build America, Buy America Act, Pub. L. No. 117-58, div. G, tit. IX, subtit. A, 135 Stat. 429, 1298 (2021) and Office of Management and Budget (OMB) Memorandum M-22-11, "Initial Implementation Guidance on Application of Buy America Preference in Federal Financial Assistance Programs for Infrastructure," as implemented by MARAD through Term B.5 of the exhibits to the agreement) are being procured, the same or equivalent certificate as set forth below shall be completed and submitted by each bidder or offeror in accordance with the requirement contained in section 2.1 of the agreement.

**Certificate of Compliance with Buy America Requirements**

The bidder or offeror hereby certifies that it will comply with the requirements of § 70914(a) of the Build America, Buy America Act, Pub. L. No. 117-58, div. G, tit. IX, subtit. A, 135 Stat. 429, 1298 (2021), as implemented by MARAD in Term B.5 of the exhibits to the grant agreement.

Date \_\_\_\_\_  
Signature \_\_\_\_\_  
Company \_\_\_\_\_  
Name \_\_\_\_\_  
Title \_\_\_\_\_

**Certificate of Non-Compliance with Buy America Requirements**

The bidder or offeror hereby certifies that it cannot comply with the requirements of § 70914(a) of the Build America, Buy America Act, Pub. L. No. 117-58, div. G, tit. IX, subtit. A, 135 Stat. 429, as implemented by MARAD in Term B.5 of the exhibits to the grant agreement, but it may qualify for an exception to the requirement pursuant to § 70914(b) of the Build America, Buy America Act and Term B.5.

Date \_\_\_\_\_  
Signature \_\_\_\_\_  
Company \_\_\_\_\_  
Name \_\_\_\_\_  
Title \_\_\_\_\_

**Notes:** Bidder shall identify on their bids, any deviations from the specifications or requirements in the remarks column and state the item being offered for evaluation processing. Failure to comply may result in the rejection of the bid.

**A certificate of origin is required on the sale of equipment.**

**Equipment must be delivered to the Port Authority of Guam for inspection**

**Bidding on: Telescopic Boom Lift 180' reach, Full time 4WD**

**MANUFACTURER:** \_\_\_\_\_  
**MAKE:** \_\_\_\_\_  
**MODEL:** \_\_\_\_\_  
**YEAR:** \_\_\_\_\_  
**PLACE OF ORIGIN:** \_\_\_\_\_  
**DATE OF DELIVERY:** \_\_\_\_\_

These specifications have been developed by Port Authority of Guam's, Raymond B. Santos- Transportation Superintendent, Joaquin P. Pangelinan- Equipment Service Support Manager, reviewed by Glenn B. Nelson- Operations Manager, Dominic G. Muna- DGMO, Pacifico Martir- DGMA, and approved by Rory J. Respicio- General Manager



## KEY SPECS

**Platform Height**  
185-ft 7-in / 56.56-m

**Drive Speed**  
2.8 mph / 4.5 km/h

**Horizontal Outreach**  
80-ft / 24.38-m

**Platform Capacity**  
1,000-lb / 454-kg - Restricted  
500-lb / 227-kg - Unrestricted

## KEY FEATURES

- Expansive work area of a maximum platform height of 185-ft and a telescoping jib that provides 2.9 million cubic feet of work area.
- Optimized maneuverability with full-time four-wheel drive to traverse over rough terrain.
- Enhanced Platform Controls - An LCD screen shows operators where they are in the work envelope, along with other useful information.
- Single sensor load sensing system features fewer parts and requires no weight to calibrate.

## ACCESSORIES & OPTIONS

- Accessory Packages:
  - SkyWelder® Package
  - SkyPower® Package
  - SkyGlazier® Package
- Ambient White Noise Alarm
- Bolt On Fall Arrest System
- Cold Package Plus<sup>1</sup>
- Cold Weather Package<sup>2</sup>
- Hostile Environment Package<sup>3</sup>
- Light Package
- Platform Mesh, Bolt On
  - Mesh to Top Rail, Plastic or Aluminum
- Mesh to Mid Rail, Plastic or Aluminum
- Platform Options
  - Fall Arrest, Rear Entry - 36 x 96-in
  - Drop Bar - 30 x 36-in, 36 x 96-in
  - Inward Self-Closing Swing Gate - 36 x 72-in, 36 x 96-in
  - Tri-Entry, Drop Bar - 36 x 72-in, 36 x 96-in
  - Tri-Entry, Swing Gate - 36 x 72-in, 36 x 96-in
- SkySense® Enhanced Detection System
- Soft Touch System
- Storage Tray, Center or Corner

## STANDARD SPECIFICATIONS

### Performance

Platform Height	185-ft 7-in / 56.56-m
Horizontal Outreach	80-ft / 24.38-m
Swing	360 Degrees Continuous
Platform Capacity (Restricted)	1,000-lb / 454-kg
Platform Capacity (Unrestricted)	500-lb / 227-kg
Platform Rotator	173 Degrees Hydraulic
Jib Length (Retracted/Extended)	13-ft (3.96-m) / 20-ft (6.1m)
Jib Range of Articulation	120 Degrees (+75, -45)
Weight*	59,900-lb / 27,170-kg
Max. Ground Bearing Pressure	179.6 psi / 8.41 kg/cm <sup>2</sup>
Drive Speed	2.8 mph / 4.5 km/h
Gradeability	40%
Tilt Cut Out	5 Degrees
Turning Radius (Inside):	
Axles Retracted/Extended	23-ft 4-in (7.12-m) / 7-ft 7-in (2.3-m)
Turning Radius (Outside):	
Axles Retracted/Extended	31-ft 3-in (9.52-m) / 21-ft 8-in (6.6-m)

### Engine

Diesel Engine - Deutz TCD 3.6L Tier IV F	99.8 hp / 74.4 kW
Fuel Tank Capacity	45 gal / 170 L

### Tires

Standard	44S/50D710 Foam-filled
----------	------------------------

### Hydraulic System

Capacity	75.1 gal / 284.2 L
----------	--------------------

## STANDARD FEATURES

- 12V-DC Auxiliary Power
- 173 Degrees Hydraulic Platform Rotator
- 3 Selectable Steering Modes
- AC Receptacle in Platform
- All Motion Alarm
- ClearSky Smart Fleet™ Hardware (CS550)\*\*
- Control ADE® System
- Drive-Out Extendable Axles
- Engine Distress Warning/Shutdown—Selectable via JLG Analyzer
- Full-Time 4WD
- Glow Plugs
- Gull-Wing Steel Hoods
- Hourmeter
- LED Motion/Amber Beacon (CS550)\*\*
- Lifting/Tie Down Lugs
- Load Sensing System
- LCD Panel at Operator's Platform Control Console
- Platform 36 x 96-in (91 x 2.44-m) Side Entry
- Proportional Controls
- Platform Console Machine Status Light Panel\*\*\*
- Selectable Capacity Envelope
- Swing-Out Engine Tray
- SkyGuard SkyLine™
- Tilt Light and Alarm

\*Certain Options or Country Standards Increase Weight.

\*\*Standard Beacon and ClearSky Smart Fleet Hardware Availability Varies by Model Throughout 2023.

\*\*\*Provides Indicator Lights at Platform Control Console for System Distress, Low Fuel, Degree Tilt, Light and Foot Switch Status.

1. Includes extreme cold engine oil, fuel conditioner, engine block heater, battery blanket, glow plugs, hydraulic tank heater, and oversized footswitch.
2. Includes battery blanket, hydraulic tank heater, block heater.
3. Includes console cover, boom wipers and cylinder bellows.

Additional accessories and options available via JLG Aftermarket.

Shown with Optional Mesh to Top Rail

## DIMENSIONS

## REACH DIAGRAM

All dimensions are approximate

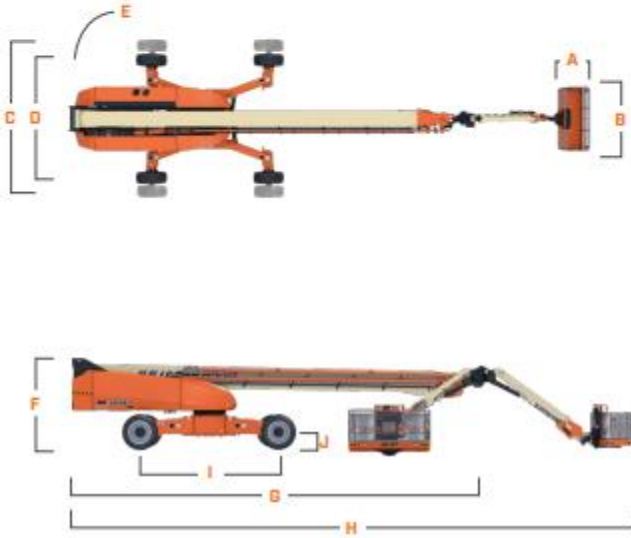

A. Platform Width	36-in / 91-cm
B. Platform Length	96-in / 2.44-m
C. Machine Width - Axles Extended	16-ft 6-in / 5-m
D. Machine Width - Axles Retracted	8-ft 2-in / 2.49-m
E. Tailswing	7-ft 7-in / 2.32-m
F. Machine Height	10-ft / 3.05-m
G. Machine Length - Stowed	47-ft 9.5-in / 14.57-m
H. Machine Length - Overall	63-ft 10-in / 19.45-m
I. Wheelbase	17-ft 1.5-in / 5.22-m
J. Ground Clearance	13.5-in / 34-cm - Axle 16.25-in / 41-cm - Chassis

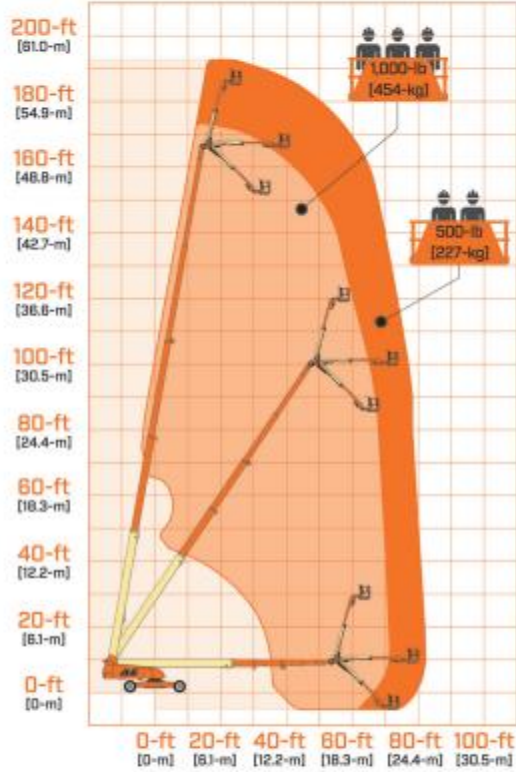

We provide coverage for one (1) full year, and cover all specified major structural components for five (5) years. Due to continuous product improvements, we reserve the right to make specification and/or equipment changes without prior notification. This machine meets or exceeds applicable ANSI and CSA requirements based on machine configuration as originally manufactured for intended applications. Please reference the serial number plate on the machine for additional information.

Part No. 3131030 | R0823\_06



**JLG INDUSTRIES, INC.**  
Toll-free US 877-JLG-LIFT  
JLG.com  
An Dshkosh Corporation Company



## Exhibit A

### **PORT AUTHORITY OF GUAM FEDERAL CONTRACT SUPPLEMENT**

All boxes marked below are terms and conditions applicable to the Agreement entered by the Port Authority of Guam (“PAG”) and Contractor, which is funded in whole or in part by federal award funds, as supplemented with these federally required terms. To the extent that any of the contractual terms, provisions, or conditions of the Agreement are inconsistent with the applicable terms, provisions, or conditions of this Federal Contract Supplement, the applicable terms of this Federal Contract Supplement shall govern.

#### **DOMESTIC PRODUCTS PREFERENCE**

As appropriate and to the extent consistent with law, there is a preference for the purchase, acquisition, or use of goods, products, or materials produced in the United States (including but not limited to iron, aluminum, steel, cement, and other manufactured products). The requirements of this section must be included in all subcontracts, including all purchase orders for work or products under this subaward. For purposes of this section: “Produced in the United States” means, for iron and steel products, that all manufacturing processes, from the initial melting stage through the application of coatings, occurred in the United States.

#### **PROHIBITION ON CERTAIN TELECOMMUNICATIONS AND VIDEO SURVEILLANCE SERVICES AND EQUIPMENT**

For the purpose of public safety, security of government facilities, physical security surveillance of critical infrastructure, and other national security purposes, Contractor and all subcontractors are prohibited from procuring, obtaining, or purchasing: 1) equipment, services, or systems that uses covered telecommunications equipment or services as a substantial or essential component of any system, or as critical technology as part of any system. As described in Public Law 115-232, section 889, covered telecommunications equipment is telecommunications equipment produced by Huawei Technologies Company or ZTE Corporation (or any subsidiary or affiliate of such entities); 2) video surveillance and telecommunications equipment produced by Hytera Communications Corporation, Hangzhou Hikvision Digital Technology Company, or Dahua Technology Company (or any subsidiary or affiliate of such entities); 3) telecommunications or video surveillance services provided by such entities or using such equipment; and 4) telecommunications or video surveillance equipment or services produced or provided by an entity that the Secretary of Defense, in consultation with the Director of the National Intelligence or the Director of the Federal Bureau of Investigation, reasonably believes to be an entity owned or controlled by, or otherwise connected to, the government of a covered foreign country.

#### **PROCUREMENT OF RECOVERED MATERIALS**

Contractor and all subcontractors must comply with section 6002 of the Solid Waste Disposal Act, as amended by the Resource Conservation and Recovery Act. The requirements of Section 6002 include procuring only items designated in guidelines of the Environmental Protection Agency (EPA) at 40 CFR part 247 that contain the highest percentage of recovered materials practicable, consistent with maintaining a satisfactory level of competition, where the purchase price of the item exceeds \$10,000 or the value of the quantity acquired during the preceding fiscal year exceeded \$10,000; procuring solid waste management services in a manner that maximizes energy and resource recovery; and establishing an affirmative procurement program for procurement of recovered materials identified in the EPA guidelines.

#### **UNALLOWABLE COSTS**

Contractor agrees to comply with all applicable laws, regulations, policies, and guidance (including specific cost limits, prior approval and reporting requirements, where applicable) governing the use of federal funds. Costs that are expressly unallowable under federal funding laws, or costs which specifically become designated as unallowable as a result of a written decision furnished by a contracting officer pursuant to contract dispute procedures, or costs which are mutually agreed to be unallowable, including mutually agreed to be unallowable directly associated costs, shall be identified and excluded from any invoice, billing, claim, or proposal applicable to a federally funded contract. A directly associated cost is any cost which is generated solely as a result of incurring another cost, and which would not have been incurred had the other cost not been incurred. When an

unallowable cost is incurred, its directly associated costs are also unallowable. Contractor agrees to pay any penalties associated with any unallowable costs.

**NO OBLIGATION BY THE FEDERAL GOVERNMENT**

PAG and Contractor acknowledge and agree that, notwithstanding any concurrence by the Federal Government in or approval of the solicitation or award of the underlying Agreement, absent the express written consent by the Federal Government, the Federal Government is not a party to this contract and shall not be subject to any obligations or liabilities to PAG. Contractor, or any other party (whether or not a party to the contract) pertaining to any matter resulting from the underlying contract. Contractor agrees to include the above clause in each subcontract financed in whole or in part with Federal funds under this Agreement. It is further agreed that the clause shall not be modified, except to identify the subcontractor who will be subject to its provisions.

**FEDERAL LOBBYING**

The Contractor certifies, to the best of his or her knowledge and belief, that:

A. No Federal appropriated funds have been paid or will be paid, by or on behalf of the undersigned, to any person for influencing or attempting to influence an officer or employee of an agency, a Member of Congress, an officer or employee of Congress, or an employee of a Member of Congress in connection with the awarding of this Agreement, the making of any Federal grant, the making of any Federal loan, the entering into of any cooperative agreement, and the extension, continuation, renewal, amendment, or modification of this Agreement or any Federal grant, loan, or cooperative agreement.

B. If any funds other than Federal appropriated funds have been paid or will be paid to any person for making lobbying contacts to an officer or employee of any agency, a Member of Congress, an officer or employee of Congress, or an employee of a Member of Congress in connection with this Agreement, or any Federal grant, loan, or cooperative agreement, the undersigned shall complete and submit Standard Form--LLL, "Disclosure Form to Report Lobbying," in accordance with its instructions [as amended by "Government wide Guidance for New Restrictions on Lobbying," 61 Fed. Reg. 1413 (1/19/96). Note: Language in paragraph (2) herein has been modified in accordance with Section 10 of the Lobbying Disclosure Act of 1995 (P.L. 104-65, to be codified at 2 U.S.C. 1601, et seq.)]

C. The Contractor shall require that the language of this certification be included in the award documents for all subawards at all tiers (including subcontracts, subgrants, and contracts under grants, loans, and cooperative agreements) and that all subcontractors shall certify and disclose accordingly.

D. This certification is a material representation of fact upon which reliance was placed when this transaction was made or entered into. Submission of this certification is a prerequisite for making or entering into this Agreement. The Contractor certifies or affirms the truthfulness and accuracy of each statement of this certification and disclosure. In addition, the Contractor understands and agrees that the provisions of 31 U.S.C. A 3801, et seq., apply to this certification and disclosure.

**ALL PUBLISHED ITEMS AND DELIVERABLES MUST INCLUDE NAME OF FEDERAL AWARDING AGENCY AND AWARD NUMBER**

Contractor agrees to include the Program logo and the logos of the Federal Awarding Agency, the PAG, and the government of Guam on any materials developed for publication. Contractor further agrees to ensure statements, press releases, public service announcements, media interviews, requests for proposals, bid solicitations, and other documents or activities carried out in whole or part with program funds shall clearly state: (1) the dollar amount of federal funds for the project; (2) the Federal Award Number; and (3) the involvement of the Federal Awarding Agency, the PAG, and the government of Guam.

**DEBARMENT (GUAM AND FEDERAL)**

A. **Guam Debarment and Suspension.** Contractor warrants that it will comply with the provisions of 5 GCA Chapter 5 Articles 9 and 11, subject to debarment or suspension, and that it will not employ any subcontractors who have been federally debarred or debarred by the Government of Guam.

B. **Federal Debarment and Suspension (Executive Orders 12549 and 12689).** A contract award (see 2 CFR 180.220) must not be made to parties listed on the government-wide exclusions in the System for Award

Management (SAM), in accordance with the OMB guidelines at 2 CFR 180 that implement Executive Orders 12549 (3 CFR part 1986 Comp., p. 189) and 12689 (3 CFR part 1989 Comp., p. 235), "Debarment and Suspension." SAM Exclusions contains the names of parties debarred, suspended, or otherwise excluded by agencies, as well as parties declared ineligible under statutory or regulatory authority other than Executive Order 12549. As required by Executive Order 12549, Debarment and Suspension, and implemented at 34 CFR Part 85, for prospective participants in primary covered transactions, as defined at 34 CFR Part 85, Sections 85.105 and 85.110. The Contractor certifies that it and its principals: 1) Are not presently debarred, suspended, proposed for debarment, declared ineligible, or voluntarily excluded from covered transactions by any federal department or agency; 2) Have not within a three-year period preceding this application been convicted of or had a civil judgment rendered against them for commission of fraud or a criminal offense in connection with obtaining, attempting to obtain, or performing a public (federal, state, or local) transaction or contract under a public transaction; violation of federal or state antitrust statutes or commission of embezzlement, theft, forgery, bribery, falsification or destruction of records, making false statements, or receiving stolen property; 3) Are not presently indicted for or otherwise criminally or civilly charged by a governmental entity (federal, state, or local) with commission of any of the offenses enumerated above; and 4) Have not within a three-year period preceding this application had one or more public transactions (federal, state, or local) terminated for cause or default. Contractor further warrants that it is not a party listed on the government wide exclusions in the System for Award Management (SAM), and will comply with the provisions of Subpart C of 2 CFR Part 1326, "Nonprocurement Debarment and Suspension," (published in the Federal Register on December 21, 2006, 71 FR 76573) which generally prohibits entities that have been debarred, suspended, or voluntarily excluded from participating in nonprocurement transactions either through primary or lower tier covered transactions, and which sets forth the responsibilities of recipients of federal financial assistance regarding transactions with other persons, including subrecipients and contractors. Contractor will provide a Certification Regarding Debarment, Suspension, Ineligibility, and Voluntary Exclusion, Lower Tier Covered Transaction (Sub-Recipient), which is a material representation of fact. Submission of this certification is a pre-requisite for entering into this Agreement, imposed by Executive Order 12549, 28 CFR Part 67, Section 67.510.

**ACCESS TO RECORDS, INSPECTION, AND AUDIT REVIEW**

A. **Access to Records.** The Contractor, including its subcontractors, if any, shall maintain all books, documents, papers, accounting records and other evidence pertaining to costs incurred and to make such materials available at their respective office at all reasonable times during the contract period and for three (3) years from the date of final payment under this Formal Agreement, for inspection by the PAG. Each subcontract by the Contractor pursuant to this Agreement shall include a provision containing the conditions of this Section.

B. **Right to Audit.** Contractor shall establish and maintain a reasonable accounting system that enables the PAG to readily identify Contractor's assets, expenses, costs of goods, and use of funds. the PAG and its authorized representatives shall have the right to audit, to examine, and to make copies of or extracts from all financial and related records (in whatever form they may be kept, whether written, electronic, or other) relating to or pertaining to this Agreement kept by or under the control of the Contractor, including, but not limited to those kept by the Contractor, its employees, agents, assigns, successors, and subcontractors. Such records shall include, but not be limited to, accounting records, written policies and procedures; subcontract files (including proposals of successful and unsuccessful bidders, bid recaps, etc.); all paid vouchers including those for out-of-pocket expenses; other reimbursement supported by invoices; ledgers; cancelled checks; deposit slips; bank statements; journals; original estimates; estimating work sheets; contract amendments and change order files; backcharge logs and supporting documentation; insurance documents; payroll documents; timesheets; memoranda; and correspondence. Contractor shall, at all times during the term of this Agreement and for a period of ten years after the completion of this Agreement, maintain such records, together with such supporting or underlying documents and materials. The Contractor shall at any time requested by the PAG, whether during or after completion of this Agreement, and at Contractor's own expense make such records available for inspection and audit (including copies and extracts of records as required) by the PAG. Such records shall be made available to the PAG during normal business hours at the Contractor's office or place of business and [subject to a three-day written notice/without prior notice]. In the event that no such location is available, then the financial records, together with the supporting or underlying documents and records, shall be made available for audit at a time and location that is convenient for the PAG. Contractor shall ensure the PAG has these rights with Contractor's employees, agents, assigns, successors, and subcontractors, and the obligations of these rights shall be explicitly included in any subcontracts or agreements formed between the Contractor and any subcontractors to the extent that those subcontracts or agreements relate to fulfillment of the Contractor's obligations to the PAG. Costs of any audits conducted under the authority of this right to audit and not addressed elsewhere will be borne by the PAG unless certain exemption criteria are met. If the audit identifies overpricing or overcharges (of any nature) by the Contractor to the PAG in excess of one-half of one percent (.5%) of the total contract billings, the Contractor shall reimburse the PAG for the total costs of the audit. If the audit discovers substantive findings related to fraud, misrepresentation, or non-performance, the PAG may recoup the costs of the audit work from the Contractor. Any adjustments and/or payments that must be made as a result of any such audit or inspection of the Contractor's

invoices and/or records shall be made within a reasonable amount of time (not to exceed 90 days) from presentation of the PAG's findings to Contractor.

C. **Right to Enter and Inspect.** the PAG may, at any time, without notice, enter and inspect a Contractor's or subcontractor's facilities, place(s) of business, or any place(s) of performance of this Agreement. the PAG may enter and inspect any plans, supplies, services, equipment, work and records at these locations which are related to the performance of this Agreement, and may conduct any testing deemed necessary to determine whether the Contractor's or subcontractor's compliance or conformity to the solicitation or contract requirements. Guam may enter and audit the cost or pricing data, books, and records of the Contractor or any subcontractor, and/or investigate in connection with an action to debar or suspend a person from consideration for award of contracts pursuant to §9102 (Authority to Debar or Suspend) of the Guam Procurement Rules and Regulations.

**FEDERAL REQUIREMENTS**

Contractor agrees to comply with all applicable federal law, regulations, and executive orders, all standards, orders, requirements set forth under the federal award that is funding this Agreement, and all policies, procedures, and directives issued by the Federal Awarding Agency.

**MODIFICATION**

This Agreement may only be amended, modified, or extended in accordance with the applicable federal law, the terms and conditions of the federal award that is funding this Agreement, and the policies and procedures of the Federal Awarding Agency. Deviations from budget, project scope, objective, and/or time of performance require notification to the Federal Awarding Agency, and may require prior approval of the Federal Awarding Agency.

**FALSE CLAIMS AND WHISTLEBLOWERS**

Contractor acknowledges that 31 U.S.C. Chap. 38 (Administrative Remedies for False Claims and Statements) and Title 5 GCA Chapter 37, the False Claims and Whistleblower Act applies to this Agreement and to all Contractor's actions pertaining to this Agreement. The False Claims and Whistleblower Act was passed as Public Law 34-116, Chapter III, Section 20 (lapsed into law August 24, 2018) and codified at Title 5 GCA Chapter 37.

**IMPLEMENTATION OF CLEAN AIR ACT AND FEDERAL WATER POLLUTION CONTROL ACT**

(APPLICABLE TO ALL CONTRACTS AND SUBCONTRACTS EXCEEDING \$150,000)

Contractor agrees to comply with all applicable standards, orders, or requirements issued under Section 306 of the Clean Air Act (42 USC, 1857H), Section 508 of the Clean Water Act (33 USC, 1368), Executive Order 11378, and Environmental Protection Agency regulations (40 C.F.R., Part 15), which prohibit the use under nonexempt federal contracts, grants, or loans of facilities included on the EPA list of Violating Facilities. Contractor shall report violations to the PAG and to the USEPA Assistant Administrator for Enforcement (ENO329).

By executing this contract, and any subcontracts, as appropriate, the Contractor and any subcontractors will be deemed to have stipulated as follows:

A. That any person who is or will be utilized in the performance of this contract is not prohibited from receiving an award due to a violation of Section 508 of the Clean Water Act or Section 306 of the Clean Air Act.

B. That the Contractor agrees to include or cause to be included the requirements of paragraph (A) of this Section in every subcontract, and further agrees to take such action as the contracting agency may direct as a means of enforcing such requirements.

**EQUAL EMPLOYMENT OPPORTUNITY COMPLIANCE**

(APPLICABLE TO ALL CONSTRUCTION CONTRACTS AND SUBCONTRACTS)

The Contractor and all subcontractors must comply with the following policies: Executive Order 11246, 41 CFR 60, 29 CFR 1625-1627, Title 23 USC Section 140, the Rehabilitation Act of 1973, as amended (29 USC 794), Title VI of the Civil Rights Act of 1964, as amended, and related regulations including 49 CFR Parts 21, 26 and 27; and 23 CFR Parts 200, 230, and 633.

The Contractor and all subcontractors must also comply with: the requirements of the Equal Opportunity Clause in 41 CFR 60-1.4(b) and, for all construction contracts exceeding \$10,000, the Standard Federal Equal Employment Opportunity Construction Contract Specifications in 41 CFR 60-4.3.

A. Equal Employment Opportunity: Equal employment opportunity (EEO) requirements not to discriminate and to take affirmative action to assure equal opportunity as set forth under laws, executive orders, rules, regulations (28 CFR 35, 29 CFR 1630, 29 CFR 1625-1627, 41 CFR 60 and 49 CFR 27) and orders of the Secretary of Labor as modified by the provisions prescribed herein, and imposed pursuant to 23 U.S.C. 140 shall constitute the EEO and specific affirmative action standards for the Contractor's project activities under this contract. The provisions of the Americans with Disabilities Act of 1990 (42 U.S.C. 12101 et seq.) set forth under 28 CFR 35 and 29 CFR 1630 are incorporated by reference in this contract. In the execution of this contract, the Contractor agrees to comply with the following minimum specific requirement activities of EEO:

1) The Contractor will work with the PAG and the Federal Government to ensure that it has made every good faith effort to provide equal opportunity with respect to all of its terms and conditions of employment and in their review of activities under the contract.

2) The Contractor will accept as its operating policy the following statement:

"It is the policy of this Company to assure that applicants are employed, and that employees are treated during employment, without regard to their race, religion, sex, color, national origin, age or disability. Such action shall include: employment, upgrading, demotion, or transfer; recruitment or recruitment advertising; layoff or termination; rates of pay or other forms of compensation; and selection for training, including apprenticeship, pre-apprenticeship, and/or on-the-job training."

B. EEO Officer: The Contractor will designate and make known to the contracting officers an EEO Officer who will have the responsibility for and must be capable of effectively administering and promoting an active EEO program and who must be assigned adequate authority and responsibility to do so.

C. Dissemination of Policy: All members of the Contractor's staff who are authorized to hire, supervise, promote, and discharge employees, or who recommend such action, or who are substantially involved in such action, will be made fully cognizant of, and will implement, the Contractor's EEO policy and contractual responsibilities to provide EEO in each grade and classification of employment. To ensure that the above agreement will be met, the following actions will be taken as a minimum:

1) Periodic meetings of supervisory and personnel office employees will be conducted before the start of work and then not less often than once every six months, at which time the Contractor's EEO policy and its implementation will be reviewed and explained. The meetings will be conducted by the EEO Officer.

2) All new supervisory or personnel office employees will be given a thorough indoctrination by the EEO Officer, covering all major aspects of the Contractor's EEO obligations within thirty days following their reporting for duty with the Contractor.

3) All personnel who are engaged in direct recruitment for the project will be instructed by the EEO Officer in the Contractor's procedures for locating and hiring minorities and women.

4) Notices and posters setting forth the Contractor's EEO policy will be placed in areas readily accessible to employees, applicants for employment and potential employees.

5) The Contractor's EEO policy and the procedures to implement such policy will be brought to the attention of employees by means of meetings, employee handbooks, or other appropriate means.

D. Recruitment: When advertising for employees, the Contractor will include in all advertisements for employees the notation: "An Equal Opportunity Employer." All such advertisements will be placed in publications having a large circulation among minorities and women in the area from which the project work force would normally be derived.

1) The Contractor will, unless precluded by a valid bargaining agreement, conduct systematic and direct recruitment through public and private employee referral sources likely to yield qualified minorities and women. To meet this requirement, the Contractor will identify sources of potential minority group employees, and establish with such identified sources procedures whereby minority and women applicants may be referred to the Contractor for employment consideration.

2) In the event the Contractor has a valid bargaining agreement providing for exclusive hiring hall referrals, the Contractor is expected to observe the provisions of that agreement to the extent that the system meets the Contractor's compliance with EEO contract provisions. Where implementation of such an agreement has the effect of discriminating against minorities or women, or obligates the Contractor to do the same, such implementation violates Federal nondiscrimination provisions.

3) The Contractor will encourage its present employees to refer minorities and women as applicants for employment. Information and procedures with regard to referring such applicants will be discussed with employees.

E. Personnel Actions: Wages, working conditions, and employee benefits shall be established and administered, and personnel actions of every type, including hiring, upgrading, promotion, transfer, demotion, layoff, and termination, shall be taken without regard to race, color, religion, sex, national origin, age or disability. The following procedures shall be followed:

1) The Contractor will conduct periodic inspections of project sites to insure that working conditions and employee facilities do not indicate discriminatory treatment of project site personnel.

2) The Contractor will periodically evaluate the spread of wages paid within each classification to determine any evidence of discriminatory wage practices.

3) The Contractor will periodically review selected personnel actions in depth to determine whether there is evidence of discrimination. Where evidence is found, the Contractor will promptly take corrective action. If the review indicates that the discrimination may extend beyond the actions reviewed, such corrective action shall include all affected persons.

4) The Contractor will promptly investigate all complaints of alleged discrimination made to the Contractor in connection with its obligations under this Agreement, will attempt to resolve such complaints, and will take appropriate corrective action within a reasonable time. If the investigation indicates that the discrimination may affect persons other than the complainant, such corrective action shall include such other persons. Upon completion of each investigation, the Contractor will inform every complainant of all of their avenues of appeal.

F. Training and Promotion:

1) The Contractor will assist in locating, qualifying, and increasing the skills of minorities and women who are applicants for employment or current employees. Such efforts should be aimed at developing full journey level status employees in the type of trade or job classification involved.

2) Consistent with the Contractor's work force requirements and as permissible under Federal and State regulations, the Contractor shall make full use of training programs, i.e., apprenticeship, and on-the-job training programs for the geographical area of contract performance. In the event a special provision for training is provided under this Agreement, this subparagraph will be superseded as indicated in the special provision. The PAG may reserve training positions for persons who receive welfare assistance in accordance with 23 U.S.C. 140(a).

3) The Contractor will advise employees and applicants for employment of available training programs and entrance requirements for each.

4) The Contractor will periodically review the training and promotion potential of employees who are minorities and women and will encourage eligible employees to apply for such training and promotion.

G. Unions: If the Contractor relies in whole or in part upon unions as a source of employees, the Contractor will use good faith efforts to obtain the cooperation of such unions to increase opportunities for minorities and women. Actions by the Contractor, either directly or through a contractor's association acting as agent, will include the procedures set forth below:

1) The Contractor will use good faith efforts to develop, in cooperation with the unions, joint training programs aimed toward qualifying more minorities and women for membership in the unions and increasing the skills of minorities and women so that they may qualify for higher paying employment.

2) The Contractor will use good faith efforts to incorporate an EEO clause into each union agreement to the end that such union will be contractually bound to refer applicants without regard to their race, color, religion, sex, national origin, age or disability.

3) The Contractor is to obtain information as to the referral practices and policies of the labor union except that to the extent such information is within the exclusive possession of the labor union and such labor union refuses to furnish such information to the Contractor, the Contractor shall so certify to the PAG and shall set forth what efforts have been made to obtain such information.

4) In the event the union is unable to provide the Contractor with a reasonable flow of referrals within the time limit set forth in the collective bargaining agreement, the Contractor will, through independent recruitment efforts, fill the employment vacancies without regard to race, color, religion, sex, national origin, age or disability; making full efforts to obtain qualified and/or qualifiable minorities and women. The failure of a union to provide sufficient referrals (even though it is obligated to provide exclusive referrals under the terms of a collective bargaining agreement) does not relieve the Contractor from the requirements of this paragraph. In the event the union referral practice prevents the Contractor from meeting the obligations pursuant to Executive Order 11246, as amended, and these special provisions, the Contractor shall immediately notify the PAG.

H. Reasonable Accommodation for Applicants/Employees with Disabilities: The Contractor must be familiar with the requirements for and comply with the Americans with Disabilities Act and all rules and regulations established thereunder. Employers must provide reasonable accommodation in all employment activities unless to do so would cause an undue hardship.

I. Selection of Subcontractors, Procurement of Materials and Leasing of Equipment: The Contractor shall not discriminate on the grounds of race, color, religion, sex, national origin, age or disability in the selection and retention of subcontractors, including procurement of materials and leases of equipment. The Contractor shall take all necessary and reasonable steps to ensure nondiscrimination in the administration of this Agreement.

1) The Contractor shall notify all potential subcontractors and suppliers and lessors of their EEO obligations under this Agreement.

2) The Contractor will use good faith efforts to ensure subcontractor compliance with their EEO obligations.

J. Records and Reports: The Contractor shall keep such records as necessary to document compliance with the EEO requirements. Such records shall be retained for a period of three years following the date of the final payment to the Contractor for all the Work under this Agreement and shall be available at reasonable times and places for inspection by authorized representatives of the PAG.

1) The records kept by the Contractor shall document the following:

(a) The number and work hours of minority and non-minority group members and women employed in each work classification on the project;

(b) The progress and efforts being made in cooperation with unions, when applicable, to increase employment opportunities for minorities and women; and

(c) The progress and efforts being made in locating, hiring, training, qualifying, and upgrading minorities and women;

2) The Contractor and any subcontractors will submit an annual report to the PAG each July for the duration of the Project, indicating the number of minority, women, and non-minority group employees currently engaged in each work classification required by the Work under this Agreement. The staffing data should represent the project work force on board in all or any part of the last payroll period preceding the end of July. If on-the-job training is being required by special provision, the Contractor will be required to collect and report training data. The employment data should reflect the work force on board during all or any part of the last payroll period preceding the end of July.

**NONSEGREGATED FACILITIES**

(APPLICABLE TO ALL CONSTRUCTION CONTRACTS AND SUBCONTRACTS)

The Contractor must ensure that facilities provided for employees are provided in such a manner that segregation on the basis of race, color, religion, sex, or national origin cannot result. The Contractor may neither require such segregated use by written or oral policies nor tolerate such use by employee custom. The Contractor's obligation extends further to ensure that its employees are not assigned to perform their services at any location, under the Contractor's control, where the facilities are segregated. The term "facilities" includes waiting rooms, work areas, restaurants and other eating areas, time clocks, restrooms, washrooms, locker rooms, and other storage or dressing areas, parking lots, drinking fountains, recreation or entertainment areas, transportation, and housing provided for employees. The Contractor shall provide separate or single-user restrooms and necessary dressing or sleeping areas to assure privacy between sexes.

**DAVIS-BACON ACT COMPLIANCE**

(APPLICABLE TO ALL CONSTRUCTION CONTRACTS AND SUBCONTRACTS EXCEEDING \$2,000)

**A. Minimum wages**

1) All laborers and mechanics employed or working upon the site of the work, will be paid unconditionally and not less often than once a week, and without subsequent deduction or rebate on any account (except such payroll deductions as are permitted by regulations issued by the Secretary of Labor under the Copeland Act (29 CFR part 3)), the full amount of wages and bona fide fringe benefits (or cash equivalents thereof) due at time of payment computed at rates not less than those contained in the wage determination of the Secretary of Labor which is attached hereto and made a part hereof, regardless of any contractual relationship which may be alleged to exist between the Contractor and such laborers and mechanics.

Contributions made or costs reasonably anticipated for bona fide fringe benefits under section 1(b)(2) of the Davis-Bacon Act on behalf of laborers or mechanics are considered wages paid to such laborers or mechanics, subject to the provisions of paragraph 1.d. of this section; also, regular contributions made or costs incurred for more than a weekly period (but not less often than quarterly) under plans, funds, or programs which cover the

particular weekly period, are deemed to be constructively made or incurred during such weekly period. Such laborers and mechanics shall be paid the appropriate wage rate and fringe benefits on the wage determination for the classification of work actually performed, without regard to skill, except as provided in 29 CFR 5.5(a)(4). Laborers or mechanics performing work in more than one classification may be compensated at the rate specified for each classification for the time actually worked therein: Provided, That the employer's payroll records accurately set forth the time spent in each classification in which work is performed. The wage determination (including any additional classification and wage rates conformed under paragraph 1.b. of this section) and the Davis-Bacon poster (WH-1321) shall be posted at all times by the Contractor and its subcontractors at the site of the work in a prominent and accessible place where it can be easily seen by the workers.

2) The contracting officer shall require that any class of laborers or mechanics, including helpers, which is not listed in the wage determination and which is to be employed under the contract shall be classified in conformance with the wage determination. The contracting officer shall approve an additional classification and wage rate and fringe benefits therefore only when the following criteria have been met:

- (i) The work to be performed by the classification requested is not performed by a classification in the wage determination; and
- (ii) The classification is utilized in the area by the construction industry; and
- (iii) The proposed wage rate, including any bona fide fringe benefits, bears a reasonable relationship to the wage rates contained in the wage determination.

3) If the Contractor and the laborers and mechanics to be employed in the classification (if known), or their representatives, and the contracting officer agree on the classification and wage rate (including the amount designated for fringe benefits where appropriate), a report of the action taken shall be sent by the contracting officer to the Administrator of the Wage and Hour Division, Employment Standards Administration, U.S. Department of Labor, Washington, DC 20210. The Administrator, or an authorized representative, will approve, modify, or disapprove every additional classification action within 30 days of receipt and so advise the contracting officer or will notify the contracting officer within the 30-day period that additional time is necessary.

4) In the event the Contractor, the laborers or mechanics to be employed in the classification or their representatives, and the contracting officer do not agree on the proposed classification and wage rate (including the amount designated for fringe benefits, where appropriate), the contracting officer shall refer the questions, including the views of all interested parties and the recommendation of the contracting officer, to the Wage and Hour Administrator for determination. The Wage and Hour Administrator, or an authorized representative, will issue a determination within 30 days of receipt and so advise the contracting officer or will notify the contracting officer within the 30-day period that additional time is necessary.

5) The wage rate (including fringe benefits where appropriate) determined pursuant to paragraphs 1.b.(2) or 1.b.(3) of this section, shall be paid to all workers performing work in the classification under this contract from the first day on which work is performed in the classification.

6) Whenever the minimum wage rate prescribed in the contract for a class of laborers or mechanics includes a fringe benefit which is not expressed as an hourly rate, the Contractor shall either pay the benefit as stated in the wage determination or shall pay another bona fide fringe benefit or an hourly cash equivalent thereof.

7) If the Contractor does not make payments to a trustee or other third person, the Contractor may consider as part of the wages of any laborer or mechanic the amount of any costs reasonably anticipated in providing bona fide fringe benefits under a plan or program, Provided, That the Secretary of Labor has found, upon the written request of the Contractor, that the applicable standards of the Davis-Bacon Act have been met. The Secretary of Labor may require the Contractor to set aside, in a separate account, assets for the meeting of obligations under the plan or program.

## **B. Withholding**

The contracting agency shall upon its own action or upon written request of an authorized representative of the Department of Labor, withhold or cause to be withheld from the Contractor under this contract, or any other Federal contract with the same prime Contractor, or any other federally-assisted contract subject to Davis-Bacon prevailing wage requirements, which is held by the same prime Contractor, so much of the accrued payments or advances as may be considered necessary to pay laborers and mechanics, including apprentices, trainees, and helpers, employed by the Contractor or any subcontractor the full amount of wages required by the contract. In the event of failure to pay any laborer or mechanic, including any apprentice, trainee, or helper, employed or working on the site of the work, all or part of the wages required by the contract, the PAG may, after written



notice to the Contractor, take such action as may be necessary to cause the suspension of any further payment, advance, or guarantee of funds until such violations have ceased.

### **C. Payrolls and Basic Records**

1) Payrolls and basic records relating thereto shall be maintained by the Contractor during the course of the work and preserved for a period of three years thereafter for all laborers and mechanics working at the site of the work. Such records shall contain the name, address, and social security number of each such worker, his or her correct classification, hourly rates of wages paid (including rates of contributions or costs anticipated for bona fide fringe benefits or cash equivalents thereof of the types described in section 1(b)(2)(B) of the Davis-Bacon Act), daily and weekly number of hours worked, deductions made and actual wages paid. Whenever the Secretary of Labor has found under 29 CFR 5.5(a)(1)(iv) that the wages of any laborer or mechanic include the amount of any costs reasonably anticipated in providing benefits under a plan or program described in section 1(b)(2)(B) of the Davis-Bacon Act, the Contractor shall maintain records which show that the commitment to provide such benefits is enforceable, that the plan or program is financially responsible, and that the plan or program has been communicated in writing to the laborers or mechanics affected, and records which show the costs anticipated or the actual cost incurred in providing such benefits. Contractors employing apprentices or trainees under approved programs shall maintain written evidence of the registration of apprenticeship programs and certification of trainee programs, the registration of the apprentices and trainees, and the ratios and wage rates prescribed in the applicable programs.

2) The Contractor shall submit weekly for each week in which any contract work is performed a copy of all payrolls to the PAG. The payrolls submitted shall set out accurately and completely all of the information required to be maintained under 29 CFR 5.5(a)(3)(i), except that full social security numbers and home addresses shall not be included on weekly transmittals. Instead the payrolls shall only need to include an individually identifying number for each employee (e.g., the last four digits of the employee's social security number). The required weekly payroll information may be submitted in any form desired. Optional Form WH-347 is available for this purpose from the Wage and Hour Division Web site at <http://www.dol.gov/esa/whd/forms/wh347instr.htm> or its successor site. The prime Contractor is responsible for the submission of copies of payrolls by all subcontractors. Contractors and subcontractors shall maintain the full social security number and current address of each covered worker, and shall provide them upon request to the PAG for transmission to the Wage and Hour Division of the Department of Labor for purposes of an investigation or audit of compliance with prevailing wage requirements. It is not a violation of this section for a prime contractor to require a subcontractor to provide addresses and social security numbers to the prime contractor for its own records, without weekly submission to the PAG.

3) Each payroll submitted shall be accompanied by a "Statement of Compliance," signed by the Contractor or subcontractor or his or her agent who pays or supervises the payment of the persons employed under the contract and shall certify the following:

- (i) That the payroll for the payroll period contains the information required to be provided under §5.5 (a)(3)(ii) of Regulations, 29 CFR part 5, the appropriate information is being maintained under §5.5 (a)(3)(i) of Regulations, 29 CFR part 5, and that such information is correct and complete;
- (ii) That each laborer or mechanic (including each helper, apprentice, and trainee) employed on the contract during the payroll period has been paid the full weekly wages earned, without rebate, either directly or indirectly, and that no deductions have been made either directly or indirectly from the full wages earned, other than permissible deductions as set forth in Regulations, 29 CFR part 3;
- (iii) That each laborer or mechanic has been paid not less than the applicable wage rates and fringe benefits or cash equivalents for the classification of work performed, as specified in the applicable wage determination incorporated into the contract.

4) The weekly submission of a properly executed certification set forth on the reverse side of Optional Form WH-347 shall satisfy the requirement for submission of the "Statement of Compliance" required by paragraph 3.b.(2) of this section.

5) The falsification of any of the above certifications may subject the Contractor or subcontractor to civil or criminal prosecution under section 1001 of title 18 and section 231 of title 31 of the United States Code.

6) The Contractor or subcontractor shall make the records required under this section available for inspection, copying, or transcription by authorized representatives of the contracting agency or the Department of Labor, and shall permit such representatives to interview employees during working hours on the job. If the Contractor or subcontractor fails to submit the required records or to make them available, the Federal granting agency may, after written notice to the Contractor, or the contracting agency, take such action as may be necessary to cause the suspension of any further payment, advance, or guarantee of funds. Furthermore, failure to submit the required

records upon request or to make such records available may be grounds for debarment action pursuant to 29 CFR 5.12.

#### **D. Apprentices and trainees**

##### 1) Apprentices (programs of the USDOL).

Apprentices will be permitted to work at less than the predetermined rate for the work they performed when they are employed pursuant to and individually registered in a bona fide apprenticeship program registered with the U.S. Department of Labor, Employment and Training Administration, Office of Apprenticeship Training, Employer and Labor Services, or with a State Apprenticeship Agency recognized by the Office, or if a person is employed in his or her first 90 days of probationary employment as an apprentice in such an apprenticeship program, who is not individually registered in the program, but who has been certified by the Office of Apprenticeship Training, Employer and Labor Services or a State Apprenticeship Agency (where appropriate) to be eligible for probationary employment as an apprentice.

The allowable ratio of apprentices to journeymen on the job site in any craft classification shall not be greater than the ratio permitted to the Contractor as to the entire work force under the registered program. Any worker listed on a payroll at an apprentice wage rate, who is not registered or otherwise employed as stated above, shall be paid not less than the applicable wage rate on the wage determination for the classification of work actually performed. In addition, any apprentice performing work on the job site in excess of the ratio permitted under the registered program shall be paid not less than the applicable wage rate on the wage determination for the work actually performed. Where a contractor is performing construction on a project in a locality other than that in which its program is registered, the ratios and wage rates (expressed in percentages of the journeyman's hourly rate) specified in the Contractor's or subcontractor's registered program shall be observed.

Every apprentice must be paid at not less than the rate specified in the registered program for the apprentice's level of progress, expressed as a percentage of the journeymen hourly rate specified in the applicable wage determination. Apprentices shall be paid fringe benefits in accordance with the provisions of the apprenticeship program. If the apprenticeship program does not specify fringe benefits, apprentices must be paid the full amount of fringe benefits listed on the wage determination for the applicable classification. If the Administrator determines that a different practice prevails for the applicable apprentice classification, fringes shall be paid in accordance with that determination.

In the event the Office of Apprenticeship Training, Employer and Labor Services, or a State Apprenticeship Agency recognized by the Office, withdraws approval of an apprenticeship program, the Contractor will no longer be permitted to utilize apprentices at less than the applicable predetermined rate for the work performed until an acceptable program is approved.

##### 2) Trainees (programs of the USDOL).

Except as provided in 29 CFR 5.16, trainees will not be permitted to work at less than the predetermined rate for the work performed unless they are employed pursuant to and individually registered in a program which has received prior approval, evidenced by formal certification by the U.S. Department of Labor, Employment and Training Administration.

The ratio of trainees to journeymen on the job site shall not be greater than permitted under the plan approved by the Employment and Training Administration.

Every trainee must be paid at not less than the rate specified in the approved program for the trainee's level of progress, expressed as a percentage of the journeyman hourly rate specified in the applicable wage determination. Trainees shall be paid fringe benefits in accordance with the provisions of the trainee program. If the trainee program does not mention fringe benefits, trainees shall be paid the full amount of fringe benefits listed on the wage determination unless the Administrator of the Wage and Hour Division determines that there is an apprenticeship program associated with the corresponding journeyman wage rate on the wage determination which provides for less than full fringe benefits for apprentices. Any employee listed on the payroll at a trainee rate who is not registered and participating in a training plan approved by the Employment and Training Administration shall be paid not less than the applicable wage rate on the wage determination for the classification of work actually performed. In addition, any trainee performing work on the job site in excess of the ratio permitted under the registered program shall be paid not less than the applicable wage rate on the wage determination for the work actually performed.

In the event the Employment and Training Administration withdraws approval of a training program, the Contractor will no longer be permitted to utilize trainees at less than the applicable predetermined rate for the work performed until an acceptable program is approved.

3) Equal employment opportunity. The utilization of apprentices, trainees and journeymen under this part shall be in conformity with the equal employment opportunity requirements of Executive Order 11246, as amended, and 29 CFR part 30.

**E. Compliance with Copeland Act requirements.** The Contractor shall comply with the requirements of 29 CFR part 3, which are incorporated by reference in this contract.

**F. Subcontracts.** The Contractor or subcontractor shall insert in any subcontracts the clauses contained in 29 CFR 5.5(a)(1) through (10) and such other clauses as the (write in the name of the Federal agency) may by appropriate instructions require, and also a clause requiring the subcontractors to include these clauses in any lower tier subcontracts. The prime Contractor shall be responsible for the compliance by any subcontractor or lower tier subcontractor with all the contract clauses in 29 CFR 5.5.

**G. Contract termination: debarment.** A breach of the contract clauses in 29 CFR 5.5 may be grounds for termination of the contract, and for debarment as a contractor and a subcontractor as provided in 29 CFR 5.12.

**H. Compliance with Davis-Bacon and Related Act requirements.** All rulings and interpretations of the Davis-Bacon and Related Acts contained in 29 CFR parts 1, 3, and 5 are herein incorporated by reference in this contract.

**I. Disputes concerning labor standards.** Disputes arising out of the labor standards provisions of this contract shall not be subject to the general disputes clause of this contract. Such disputes shall be resolved in accordance with the procedures of the Department of Labor set forth in 29 CFR parts 5, 6, and 7. Disputes within the meaning of this clause include disputes between the Contractor (or any of its subcontractors) and the PAG, the U.S. Department of Labor, or the employees or their representatives.

**J. Certification of eligibility.**

1) By entering into this contract, the Contractor certifies that neither it (nor he or she) nor any person or firm who has an interest in the Contractor's firm is a person or firm ineligible to be awarded Government contracts by virtue of section 3(a) of the Davis-Bacon Act or 29 CFR 5.12(a)(1).

2) No part of this contract shall be subcontracted to any person or firm ineligible for award of a Government contract by virtue of section 3(a) of the Davis-Bacon Act or 29 CFR 5.12(a)(1).

3) The penalty for making false statements is prescribed in the U.S. Criminal Code, 18 U.S.C. 1001.

**CONTRACT WORK HOURS AND SAFETY STANDARDS ACT**  
(APPLICABLE TO ALL CONTRACTS AND SUBCONTRACTS EXCEEDING \$100,000 AND INVOLVING EMPLOYMENT OF MECHANICS AND LABORERS)

As used in these paragraphs, the terms laborers and mechanics include watchmen and guards.

**A. Overtime requirements.** No contractor or subcontractor contracting for any part of the contract Work which may require or involve the employment of laborers or mechanics shall require or permit any such laborer or mechanic in any workweek in which he or she is employed on such work to work in excess of forty hours in such workweek unless such laborer or mechanic receives compensation at a rate not less than one and one-half times the basic rate of pay for all hours worked in excess of forty hours in such workweek.

**B. Violation; liability for unpaid wages; liquidated damages.** In the event of any violation of this section, the Contractor and any subcontractor responsible therefore shall be liable for the unpaid wages. In addition, such Contractor and subcontractor shall be liable to the United States (in the case of work done under contract for the District of Columbia or a territory, to such District or to such territory), for liquidated damages. Such liquidated damages shall be computed with respect to each individual laborer or mechanic, including watchmen and guards, employed in violation of the clause set forth in this section, in the sum of \$10 for each calendar day on which such individual was required or permitted to work in excess of the standard workweek of forty hours without payment of the overtime wages required by this section.

**C. Withholding for unpaid wages and liquidated damages.** the PAG shall upon its own action or upon written request of an authorized representative of the Department of Labor withhold or cause to be withheld, from any moneys payable on account of work performed by the Contractor or subcontractor under any such contract or any other Federal contract with the same prime Contractor, or any other federally-assisted contract subject to the Contract Work Hours and Safety Standards Act, which is held by the same prime Contractor, such sums as

may be determined to be necessary to satisfy any liabilities of such Contractor or subcontractor for unpaid wages and liquidated damages as provided in the clause set forth in this section.

**D. Subcontracts.** The Contractor or subcontractor shall insert in any subcontracts the clauses set forth in this section and also a clause requiring the subcontractors to include these clauses in any lower tier subcontracts. The prime Contractor shall be responsible for compliance by any subcontractor or lower tier subcontractor with the clauses set forth in this section.

**SAFETY: ACCIDENT PREVENTION**

(APPLICABLE TO ALL CONSTRUCTION CONTRACTS AND SUBCONTRACTS EXCEEDING \$100,000)

A. In the performance of this contract the Contractor shall comply with all applicable Federal, State, and local laws governing safety, health, and sanitation. The Contractor shall provide all safeguards, safety devices and protective equipment and take any other needed actions as it determines, or as the contracting officer may determine, to be reasonably necessary to protect the life and health of employees on the job and the safety of the public and to protect property in connection with the performance of the work covered by the contract.

B. It is a condition of this contract, and shall be made a condition of each subcontract, which the Contractor enters into pursuant to this contract, that the Contractor and any subcontractor shall not permit any employee, in performance of the contract, to work in surroundings or under conditions which are unsanitary, hazardous or dangerous to his/her health or safety, as determined under construction safety and health standards (29 CFR 1926) promulgated by the Secretary of Labor, in accordance with Section 107 of the Contract Work Hours and Safety Standards Act (40 U.S.C. 3704).

C. Pursuant to 29 CFR 1926.3, it is a condition of this contract that the Secretary of Labor or authorized representative thereof, shall have right of entry to any site of contract performance to inspect or investigate the matter of compliance with the construction safety and health standards and to carry out the duties of the Secretary under Section 107 of the Contract Work Hours and Safety Standards Act (40 U.S.C.3704).

**D. Hazardous Materials.**

(1) The Contractor is responsible for compliance with any applicable Federal, State, and local laws or requirements regarding hazardous materials. If the Contractor encounters a hazardous material or substance not addressed in this Agreement and if reasonable precautions will be inadequate to prevent foreseeable bodily injury or death to persons resulting from a material or substance, including but not limited to asbestos or polychlorinated biphenyl (PCB), encountered on the site by the Contractor, the Contractor shall, upon recognizing the condition, immediately stop Work in the affected area and report the condition to the PAG and the Project Manager in writing.

(2) The Contractor shall indemnify the PAG for the cost and expense incurred: (1) for remediation of a material or substance the Contractor brings to the site and negligently handles; or (2) where the Contractor fails to perform its obligations, except to the extent that the cost and expense are due to the PAG's fault or negligence.

**E. Emergencies.** In an emergency affecting safety of persons or property, the Contractor shall act, at the Contractor's discretion, to prevent threatened damage, injury or loss.

**DRUG FREE WORKPLACE**

A. The Contractor shall, within 30 days after award:

(1) Publish a statement notifying its [employees](#) that the unlawful manufacture, distribution, dispensing, possession, or use of a [controlled substance](#) is prohibited in the Contractor's workplace and specifying the actions that will be taken against [employees](#) for violations of such prohibition; (2) Establish an ongoing drug-free awareness program to inform such [employees](#) about -

(i) The dangers of drug abuse in the workplace;

(ii) The Contractor's policy of maintaining a [drug-free workplace](#);

(iii) Any available drug counseling, rehabilitation, and [employee](#) assistance programs; and

(iv) The penalties that may be imposed upon [employees](#) for drug abuse violations occurring in the workplace.

(3) [Provide](#) all [employees](#) engaged in performance of the contract with a copy of the statement required by paragraph (1) of this clause;

(4) Notify such [employees](#) in writing in the statement required by subparagraph (b)(1) of this clause that, as a condition of continued employment on this contract, the [employee](#) will -

(i) Abide by the terms of the statement; and

(ii) Notify the employer in writing of the [employee's conviction](#) under a [criminal drug statute](#) for a violation occurring in the workplace no later than 5 days after such [conviction](#).

(5) Notify the Procurement Officer in writing within 10 days after receiving notice under subdivision (4)(ii) of this clause, from an [employee](#) or otherwise receiving actual notice of such [conviction](#). The notice shall include the position [title](#) of the [employee](#);

(6) Within 30 days after receiving notice under subdivision (4)(ii) of this clause of a [conviction](#), take one of the following actions with respect to any [employee](#) who is convicted of a drug abuse violation occurring in the workplace:

(i) Taking appropriate personnel action against such [employee](#), up to and including [termination](#); or

(ii) Require such [employee](#) to satisfactorily participate in a drug abuse assistance or rehabilitation program approved for such purposes by a Federal, [State](#), or local health, law enforcement, or other appropriate [agency](#); and

(7) Make a good faith effort to maintain a [drug-free workplace](#) through implementation of paragraphs (1) through (6) of this clause.

B. The Contractor, if an [individual](#), agrees by award of the contract or [acceptance](#) of a purchase order, not to engage in the unlawful manufacture, distribution, dispensing, possession, or use of a [controlled substance](#) while performing this contract.

C. In addition to other remedies available to the PAG, the Contractor's failure to comply with the requirements of paragraph (B) or (C) of this clause may render the Contractor subject to suspension of contract [payments](#), [termination](#) of the contract for [default](#), and suspension or debarment.

**RIGHTS TO INVENTIONS MADE UNDER A CONTRACT OR AGREEMENT**  
(APPLICABLE TO ALL CONTRACTS INVOLVING EXPERIMENTAL, DEVELOPMENTAL, OR RESEARCH WORK BY A SMALL BUSINESS ENTITY OR NON-PROFIT ENTITY)

A. The Contractor must comply with all applicable requirements of 37 CFR Part 401, "Rights to Inventions Made by Nonprofit Organizations and Small Business Firms Under Government Grants, Contracts and Cooperative Agreements," and any implementing regulations issued by the OEA. The interpretation of this clause and this Agreement is subject to the definitions located at 37 CFR § 401.14.

B. The Contractor may retain the entire right, title, and interest throughout the world to each [subject invention](#) subject to the provisions of this clause and [35 U.S.C. 203](#). With respect to any [subject invention](#) in which the Contractor retains title, the Federal government shall have a nonexclusive, nontransferable, irrevocable, paid-up license to practice or have practiced for or on behalf of the United States the [subject invention](#) throughout the world.

C. **Invention Disclosure, Election of Title and Filing of Patent Application by Contractor**

1. The Contractor will disclose each [subject invention](#) to the OEA ("Federal Agency") within two months after the inventor discloses it in writing to Contractor personnel responsible for patent matters. The disclosure to the agency shall be in the form of a written report and shall identify the contract under which the [invention](#) was [made](#) and the inventor(s). It shall be sufficiently complete in technical detail to convey a clear understanding to the extent known at the time of the disclosure, of the nature, purpose, operation, and the physical, chemical, biological or electrical characteristics of the [invention](#). The disclosure shall also identify any publication, on sale or public use of the [invention](#) and whether a manuscript describing the [invention](#) has been submitted for publication and, if so, whether it has been accepted for publication at the time of disclosure. In addition, after disclosure to the agency, the Contractor will promptly notify the agency of the acceptance of any manuscript describing the [invention](#) for publication or of any on sale or public use planned by the Contractor.

2. The Contractor will elect in writing whether or not to retain title to any such [invention](#) by notifying the Federal agency within two years of disclosure to the Federal agency. However, in any case where a patent, a printed publication, public use, sale, or other availability to the public has initiated the one year [statutory period](#) wherein valid patent protection can still be obtained in the United States, the period for election of title may be shortened by the agency to a date that is no more than 60 days prior to the end of the [statutory period](#).

3. The Contractor will file its [initial patent application](#) on a [subject invention](#) to which it elects to retain title within one year after election of title or, if earlier, prior to the end of any [statutory period](#) wherein valid patent protection can be obtained in the United States after a publication, on sale, or public use. If the Contractor files a provisional application as its [initial patent application](#), it shall file a non-provisional application within 10 months of the filing of the provisional application. The Contractor will file [patent applications](#) in additional countries or international patent offices within either ten months of the first filed [patent application](#) or six months from the date permission is granted by the Commissioner of Patents to file foreign [patent applications](#) where such filing has been prohibited by a Secrecy Order.

4. For any [subject invention](#) with Federal agency and Contractor co-inventors, where the Federal agency employing such co-inventor determines that it would be in the interest of the government, pursuant to [35](#)

[U.S.C. 207\(a\)\(3\)](#), to file an [initial patent application](#) on the [subject invention](#), the Federal agency employing such co-inventor, at its discretion and in consultation with the Contractor, may file such application at its own expense, provided that the Contractor retains the ability to elect title pursuant to [35 U.S.C. 202\(a\)](#).

5. Requests for extension of the time for disclosure, election, and filing under paragraphs (1), (2), and (3) of this clause may, at the discretion of the Federal agency, be granted. When a Contractor has requested an extension for filing a non-provisional application after filing a provisional application, a one-year extension will be granted unless the Federal agency notifies the Contractor within 60 days of receiving the request.

#### **D. Conditions When the Government May Obtain Title**

The Contractor will convey to the Federal agency, upon written request, title to any [subject invention](#):

1. If the Contractor fails to disclose or elect title to the [subject invention](#) within the times specified in paragraph (C) of this clause, or elects not to retain title.

2. In those countries in which the Contractor fails to file [patent applications](#) within the times specified in paragraph (C) of this clause; provided, however, that if the Contractor has filed a [patent application](#) in a country after the times specified in paragraph (C) of this clause, but prior to its receipt of the written request of the Federal agency, the Contractor shall continue to retain title in that country.

3. In any country in which the Contractor decides not to continue the prosecution of any non-provisional [patent application](#) for, to pay a maintenance, annuity or renewal fee on, or to defend in a reexamination or opposition proceeding on, a patent on a [subject invention](#).

#### **E. Minimum Rights to Contractor and Protection of the Contractor Right to File**

1. The Contractor will retain a nonexclusive royalty-free license throughout the world in each [subject invention](#) to which the Government obtains title, except if the Contractor fails to disclose the [invention](#) within the times specified in (C), above. The Contractor's license extends to its domestic subsidiary and affiliates, if any, within the corporate structure of which the Contractor is a party and includes the right to grant sublicenses of the same scope to the extent the Contractor was legally obligated to do so at the time the contract was awarded. The license is transferable only with the approval of the Federal agency except when transferred to the successor of that party of the Contractor's business to which the [invention](#) pertains.

2. The Contractor's domestic license may be revoked or modified by the funding Federal agency to the extent necessary to achieve expeditious [practical application](#) of the [subject invention](#) pursuant to an application for an exclusive license submitted in accordance with applicable provisions at [37 CFR part 404](#) and agency licensing regulations (if any). This license will not be revoked in that field of use or the geographical areas in which the Contractor has achieved [practical application](#) and continues to make the benefits of the [invention](#) reasonably accessible to the public. The license in any foreign country may be revoked or modified at the discretion of the funding Federal agency to the extent the Contractor, its licensees, or the domestic subsidiaries or affiliates have failed to achieve [practical application](#) in that foreign country.

3. Before revocation or modification of the license, the funding Federal agency will furnish the Contractor a written notice of its intention to revoke or modify the license, and the Contractor will be allowed thirty days (or such other time as may be authorized by the funding Federal agency for good cause shown by the Contractor) after the notice to show cause why the license should not be revoked or modified. The Contractor has the right to appeal, in accordance with applicable regulations in [37 CFR part 404](#) and agency regulations (if any) concerning the licensing of Government-owned inventions, any decision concerning the revocation or modification of the license.

#### **F. Contractor Action to Protect the Government's Interest**

1. The Contractor agrees to execute or to have executed and promptly deliver to the Federal agency all instruments necessary to: (i) establish or confirm the rights the Government has throughout the world in those [subject inventions](#) to which the Contractor elects to retain title; and (ii) convey title to the Federal agency when requested under paragraph (D) above and to enable the government to obtain patent protection throughout the world in that [subject invention](#).

2. The Contractor agrees to require, by written agreement, its employees, other than clerical and nontechnical employees, to disclose promptly in writing to personnel identified as responsible for the administration of patent matters and in a format suggested by the Contractor each [subject invention made](#) under contract in order that the Contractor can comply with the disclosure provisions of paragraph (C) of this clause, to assign to the Contractor the entire right, title and interest in and to each [subject invention made](#) under contract, and to execute all papers necessary to file [patent applications](#) on [subject inventions](#) and to establish the government's rights in the [subject inventions](#). This disclosure format should require, as a minimum, the information required by paragraph (C)(1) of this clause. The Contractor shall instruct such employees through employee agreements or other suitable educational programs on the importance of reporting [inventions](#) in sufficient time to permit the filing of [patent applications](#) prior to U.S. or foreign statutory bars.

3. For each [subject invention](#), the Contractor will, no less than 60 days prior to the expiration of the statutory deadline, notify the Federal agency of any decision: Not to continue the prosecution of a non-provisional [patent application](#); not to pay a maintenance, annuity or renewal fee; not to defend in a reexamination or opposition proceeding on a patent, in any country; to request, be a party to, or take action in a trial proceeding before the Patent Trial and Appeals Board of the U.S. Patent and Trademark Office, including but not limited to

post-grant review, review of a business method patent, *inter partes* review, and derivation proceeding; or to request, be a party to, or take action in a non-trial submission of art or information at the U.S. Patent and Trademark Office, including but not limited to a pre-issuance submission, a post-issuance submission, and supplemental examination.

4. The Contractor agrees to include, within the specification of any United States [patent applications](#) and any patent issuing thereon covering a [subject invention](#), the following statement, “This [invention](#) was [made](#) with government support under the Agreement for Professional Technical Advisory Services between Contractor and OOG, awarded by the OOG under Federal Award Number HQ0005171035. The government has certain rights in the [invention](#).”

#### **G. Subcontracts**

1. The Contractor will include this clause, suitably modified to identify the parties, in all subcontracts, regardless of tier, for experimental, developmental or research work to be performed by a subcontractor. The subcontractor will retain all rights provided for the Contractor in this clause, and the Contractor will not, as part of the consideration for awarding the subcontract, obtain rights in the subcontractor's subject inventions.

2. The Contractor will include in all other subcontracts, regardless of tier, for experimental developmental or research work the patent rights clause required by the FAR or the Terms and Conditions of Federal Award Number HQ0005171035.

3. In the case of subcontracts, at any tier, when the prime award with the Federal agency was a contract (but not a grant or cooperative agreement), the OEA, subcontractor, and the [Contractor](#) agree that the mutual obligations of the parties created by this clause constitute a contract between the subcontractor and the Federal agency with respect to the matters covered by the clause; provided, however, that nothing in this paragraph is intended to confer any jurisdiction under the Contract Disputes Act in connection with proceedings under paragraph (J) of this clause.

#### **H. Reporting on Utilization of Subject Inventions**

The Contractor agrees to submit on request periodic reports no more frequently than annually on the utilization of a [subject invention](#) or on efforts at obtaining such utilization that are being [made](#) by the Contractor or its licensees or assignees. Such reports shall include information regarding the status of development, date of first commercial sale or use, gross royalties received by the [Contractor](#), and such other data and information as the agency may reasonably specify. The Contractor also agrees to provide additional reports as may be requested by the agency in connection with any march-in proceeding undertaken by the agency in accordance with paragraph (J) of this clause. As required by [35 U.S.C. 202\(c\)\(5\)](#), the agency agrees it will not disclose such information to persons outside the government without permission of the Contractor.

#### **I. Preference for United States Industry**

Notwithstanding any other provision of this clause, the Contractor agrees that neither it nor any assignee will grant to any person the exclusive right to use or sell any [subject inventions](#) in the United States unless such person agrees that any products embodying the [subject invention](#) or produced through the use of the [subject invention](#) will be manufactured substantially in the United States. However, in individual cases, the requirement for such an agreement may be waived by the Federal agency upon a showing by the Contractor or its assignee that reasonable but unsuccessful efforts have been [made](#) to grant licenses on similar terms to potential licensees that would be likely to manufacture substantially in the United States or that under the circumstances domestic manufacture is not commercially feasible.

#### **J. March-in Rights**

The Contractor agrees that with respect to any [subject invention](#) in which it has acquired title, the Federal agency has the right in accordance with the procedures in [37 CFR 401.6](#) and any supplemental regulations of the agency to require the Contractor, an assignee or exclusive licensee of a [subject invention](#) to grant a nonexclusive, partially exclusive, or exclusive license in any field of use to a responsible applicant or applicants, upon terms that are reasonable under the circumstances, and if the Contractor, assignee, or exclusive licensee refuses such a request the Federal agency has the right to grant such a license itself if the Federal agency determines that:

1. Such action is necessary because the Contractor or assignee has not taken, or is not expected to take within a reasonable time, effective steps to achieve [practical application](#) of the [subject invention](#) in such field of use.

2. Such action is necessary to alleviate health or safety needs which are not reasonably satisfied by the Contractor, assignee or their licensees;

3. Such action is necessary to meet requirements for public use specified by Federal regulations and such requirements are not reasonably satisfied by the Contractor, assignee or licensees; or

4. Such action is necessary because the agreement required by paragraph (I) of this clause has not been obtained or waived or because a licensee of the exclusive right to use or sell any [subject invention](#) in the United States is in breach of such agreement.

3b





**PORT OF GUAM**  
 ATURIDAT I PUETTON GUAHAN  
**Jose D. Leon Guerrero Commercial Port**  
 1026 Cabras Highway, Suite 201, Piti, Guam 96915  
 Telephone: 671-477-5931/35 Facsimile: 671-477-2689/4445  
 Website: [www.portguam.com](http://www.portguam.com)



**Lourdes A. Leon Guerrero**  
 Governor of Guam  
**Joshua F. Tenorio**  
 Lieutenant Governor

**AMENDMENT NO. 1**

DATE: February 14, 2024

**INVITATION FOR BID No. PAG-004-24**  
**180' Telescopic Boom Lift**

**NOTICE TO OFFERORS:** The IFB documents of the above referenced project are hereby amended to include the following as part of IFB documents:

Amend to change on page 48 of 68 under deliver **TO READ FROM:** The successful bidder shall deliver one(1) 180' Boom Lift each be new fully assembled and ready for operation to the Port Authority of Guam within 120 days **TO NOW READ:** The successful bidder shall deliver one(1) 180' Boom Lift fully assembled and ready for operation to the Port Authority of Guam within 460 days.

**\*\*\* END OF AMENDMENT NO. 1, ALL OTHERS REMAIN THE SAME \*\*\***

Issued by:

Rory J. Respicio  
 General Manager

NAME OF OFFEROR: \_\_\_\_\_

AUTHORIZED SIGNATURE: \_\_\_\_\_

PRINT NAME: \_\_\_\_\_

DATE/ TIME: \_\_\_\_\_

4a

**IFB PAG-004-24 Inquiries**

---

**From :** Ryne Santos <rsantos@fareastequipment.com> Tue, Jan 30, 2024 03:31 PM  
**Subject :** IFB PAG-004-24 Inquiries  
**To :** rjrespicio@portofguam.com  
**Cc :** pagprocurement@portofguam.com,  
algsablan@portofguam.com, Mark A. Cabrera  
<macabrera@portofguam.com>, John Limtiaco  
<jlimtiaco@fareastequipment.com>

External images are not displayed. [Display images below](#)

---

Hafa Adai PAG Procurement:

Would a boom truck with a working height of 182' 11" be acceptable in lieu of a telescopic boom lift? We recommend this option due to the greater versatility and mobility it can offer.

--Best regards,  
Ryne-Paul Santos  
Sales  
Far East Equipment Co. LLC  
P.O. Box 10838  
Tamuning, Guam 96931

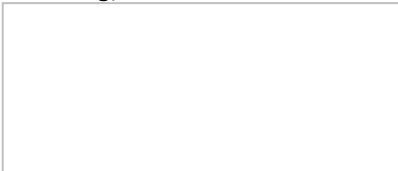

---

4b



• EQUIPMENT •

Sales, Rental, Parts and Service

ADDRESS: 197 Ypao Road, Tamuning  
Guam 96913  
OFFICE: Phone: 1-671-649-1946  
FAX: 1-671-649-1947  
SPARE PARTS: Phone: 1-671-646-7914  
Fax: 1-671-646-7900  
WEB: www.morricoequipment.com



TO: Mr. Rory J. Respicio  
General Manager  
Port Authority of Guam  
1026 Cabras Highway, Suite 201  
Piti, Guam 96915

CC: PAG Procurement  
Ms. Annie L.G. Sablan  
Inventory Management Administrator  
Mr. Mark A. Cabrera  
Buyer Supervisor

VIA: [rjrespicio@portofguam.com](mailto:rjrespicio@portofguam.com); [pagprocurement@portofguam.com](mailto:pagprocurement@portofguam.com);  
[algsablan@portofguam.com](mailto:algsablan@portofguam.com); [macabrera@portofguam.com](mailto:macabrera@portofguam.com)

DATE: 9 February 2024  
PAGES: 1

FROM: Patrick Chargualaf / Jesse Munoz / Ross Morrison

RE: **REQUEST FOR INQUIRY #1 for IFB PAG-004-24 180' TELESCOPIC BOOM LIFT from MORRICO EQUIPMENT**

Port Authority of Guam General Manager Mr. Respicio,

Hafa Adai.

Morrigo Equipment is submitting RFI #1 for IFB PAG-004-24 180' Telescopic Boom Lift:

1. Delivery Date
    - a. IFB-PAG-004-24 Page 3 of 68 "Invitation for Bid":
      - i. Required Delivery Date: (460 days ARO) upon receipt of purchase order.
    - b. IFB-PAG-004-24 Page 48 of 68 "Deliver:"
      - i. The successful bidder shall deliver one (1) 180' Boom Lift each be new fully assembled and ready for operation to the Port Authority of Guam within 120 days.
- Morrigo requests the delivery date is confirmed at 460 day ARO due to advised manufacturing schedules.

Please contact me at 649-1946 or 688-0309 if you have any questions.

Regards,  
Digitally signed by Patrick Mafnas Chargualaf  
DN: cn=Patrick Mafnas Chargualaf, o=Morrigo Equipment LLC, ou=Generator and  
Equipment Sales, email=patrick@morrigoequipment.com, c=GU  
Date: 2024.02.09 15:29:13 +10'00'

Patrick Chargualaf  
Generator and Equipment Sales  
Morrigo Equipment LLC

IFB PAG-004-24 180ft Telescopic Boom Lift\RFI 1 IFB PAG-004-24 180 ft Telescopic Boom Lift dtd 9 Feb 2024

**ON-SITE DIESEL DELIVERY**



4c



**PORT OF GUAM**  
 ATURIDAT I PUETTON GUAHAN  
 Jose D. Leon Guerrero Commercial Port  
 1026 Cabras Highway, Suite 201, Piti, Guam 96915  
 Telephone: 671-477-5931/35 Facsimile: 671-477-2689/4445  
 Website: [www.portguam.com](http://www.portguam.com)



Lourdes A. Leon Guerrero  
 Governor of Guam  
 Joshua F. Tenorio  
 Lieutenant Governor

February 14, 2024

**INVITATION FOR BID IFB-PAG-004-24**  
**180' Telescopic Boom Lift**  
**Questions and Responses**

Question submitted by Far East Equipment via e-mail on January 30, 2024

Question #1: Would a boom truck with a working height of 182'11" be acceptable in lieu of a telescopic boom lift? We recommend this option due to the greater versatility and mobility it can offer.

PAG's Response: No. The equipment indicated is approved as specified by the Federal Grantor

Question submitted by Morrico Equipment via e-mail on February 9, 2024

Question #1: Delivery Date a. IFB-PAG-004-24 Page 3 of 68 "Invitation for Bid": i. Required Delivery Date: (460 days ARO) upon receipt of purchase order. b. IFB-PAG-004-24 Page 48 of 68 "Deliver:" i. The successful bidder shall deliver one (1) 180' Boom Lift each be new fully assembled and ready for operation to the Port Authority of Guam within 120 days. - Morrico requests the delivery date is confirmed at 460 day ARO due to advised manufacturing schedules.

PAG's Response: See Amendment #1

Rory J. Respicio  
 General Manager

<b>ACKNOWLEDGEMENT</b>	
NAME:	_____
COMPANY:	_____
DATE/TIME:	_____

# 5a

Feb. 16, 2024 Bid Opening Audio Recording



5b



**PORT OF GUAM**  
 ATURIDAT I PUETTON GUAHAN  
**Jose D. Leon Guerrero Commercial Port**  
 1026 Cabras Highway, Suite 201, Piti, Guam 96915  
 Telephone: 671-477-5931/35 Facsimile: 671-477-2689/4445  
 Website: www.portguam.com



Lourdes A. Leon Guerrero  
 Governor of Guam  
 Joshua F. Tenorio  
 Lieutenant Governor

Accountability \* Impartiality \* Competence \* Openness \* Value

**INVITATION FOR BID NO.: IFB PAG-004-24**

**DESCRIPTION:**

**180' Telescopic Boom Lift**

**SPECIAL REMINDER TO PROSPECTIVE BIDDERS**

Bidders are reminded to read the Sealed Bid Solicitation and Instructions, and General Terms and Conditions attached to the IFB to ascertain that all of the following requirements checked below are submitted in the bid envelope, in duplicate (one marked original with other marked copy), and (1) CD or USB containing electronic file copy in PDF format, at the date and time for bid opening.

- [X] **BID GUARANTEE (15% of Bid Amount) May be in the form of;**  
**Reference #11 on the General Terms and Conditions**
  - a. Cashier's Check or Certified Check
  - b. Letter of Credit
  - c. Surety Bond – Valid only if accompanied by:
    - 1. Current Certificate of Authority issued by the Insurance Commissioner;
    - 2. Power of Attorney issued by the Surety to the Resident General Agent;
    - 3. Power of Attorney issued by two (2) major officers of the Surety to whoever is signing on their behalf.
  
- [X] BROCHURES/DESCRIPTIVE LITERATURE;
  
- [X] AFFIDAVIT DISCLOSING OWNERSHIP and COMMISSION
  - a. Date of signature of the person authorized to sign the bid and the notary date must be the same.
  
- [X] OTHER REQUIREMENTS:  
Disclosure of Shareholder & Commission, Non-Collusion Declaration, D.O.L. Wage Determination Declaration, Restriction against Sexual Offenders Declaration, No Kickbacks or Gratuities Declaration and Ethical Standards Declaration, and Declaration re Contingent Fees, Conflict of Interest Form, SF-LLL Byrd Anti-Lobbying, and Business License- must be current at the time of award.

**This reminder must be signed and returned in the bid envelope together with the bid. Failure to comply with the above requirements may be cause for disqualification and rejection of the bid.**

On this 15th day of February, 2024, I, Jesse Munoz

authorized representative of Morrice Equipment LLC acknowledge receipt of this special reminder to prospective bidders with the above referenced IFB.

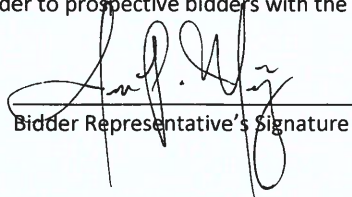
  
 Bidder Representative's Signature

**ORIGINAL**

INVITATION FOR BID NO.: IFB-PAG-004-24

**180' Telescopic Boom Lift**

**ACKNOWLEDGEMENT RECEIPT FORM**

Please be advised that to be considered a prospective bidder you must fill out this Acknowledgement receipt form. Please submit by fax form to **(671) 472-1439** or email to **[:macabrera@portofguam.com](mailto:macabrera@portofguam.com)**, and **[pagprocurement@portofguam.com](mailto:pagprocurement@portofguam.com)**

**Acknowledgement Receipt Form must be submitted no later than three (3) days upon receipt of IFB package.**

<b>Name</b>	<u>Patrick Mafnas Chargualaf</u>
<b>Signature</b>	<small>Digitally signed by Patrick Mafnas Chargualaf DN: cn=Patrick Mafnas Chargualaf, o=Morrice Equipment LLC, ou=Generator and Equipment Sales, email=patrick@morriceequipment.com, c=GU Date: 2024.01.28 21:55:49 +1000</small>
<b>Date</b>	<u>01/28/2024</u>
<b>Time</b>	<u>9:52 PM</u>
<b>Contact Number</b>	<u>(671) 649-1946 / 688-0309</u>
<b>Fax Number</b>	<u>(671) 649-1947</u>
<b>Contact Person regarding IFB</b>	<u>Patrick Mafnas Chargualaf</u>
<b>Title</b>	<u>Generator and Equipment Sales</u>
<b>E-Mail Address</b>	<u>patrick@morriceequipment.com</u>
<b>Company/Firm</b>	<u>Morrice Equipment</u>
<b>Address</b>	<u>197 Ypao Road, Tamuning, Guam 96913</u>

Note: IFB recommends that prospective bidders register current contact information with IFB to ensure they receive any notices regarding any changes or update to the IFB. The procuring agency and IFB will not be liable for failure to provide notice to any party who did not register current contact information.

All questions and concerns in regards to this bid must be submitted to the PORT AUTHORITY OF GUAM via fax or email, addressed to the GENERAL MANAGER no later than Friday, February 9, 2024 by the close of business at 5:00pm. Your inquiry may be sent by fax to (671)472-1439, or emailed to **[rjrespicio@portofguam.com](mailto:rjrespicio@portofguam.com)** and copied to **[pagprocurement@portofguam.com](mailto:pagprocurement@portofguam.com)**, **[algsablan@portofguam.com](mailto:algsablan@portofguam.com)**, and **[macabrera@portofguam.com](mailto:macabrera@portofguam.com)**.

No entitlement to Preparation Costs- The bidder expressly waives any right it may have against the government for any expenses incurred in connection with the preparation of its bid.

**ORIGINAL**

Re: IFB-PAG-004-24: 180' Telescopic Boom Lift

Mark A. Cabrera <macabrera@portofguam.com>

Fri 2/2/2024 11:16 AM

To: Patrick Chargualaf <Patrick@morricequipment.com>

Cc: pagprocurement <pagprocurement@portofguam.com>; Ross Morrison <Ross@morricequipment.com>; Jesse Munoz <Jesse.Munoz@morricequipment.com>; Joel Lesh <Joel.Lesh@MorricoEquipment.com>

---

**This Message Is From an External Sender**

This message came from outside your organization.

Hello Mr. Chargualaf-

Acknowledged.

Mark

---

**From:** "Patrick Chargualaf" <Patrick@morricequipment.com>  
**To:** "Mark A. Cabrera" <macabrera@portofguam.com>, "pagprocurement" <pagprocurement@portofguam.com>  
**Cc:** "Ross Morrison" <Ross@morricequipment.com>, "Jesse Munoz" <Jesse.Munoz@morricequipment.com>, "Joel Lesh" <Joel.Lesh@MorricoEquipment.com>  
**Sent:** Sunday, January 28, 2024 9:59:43 PM  
**Subject:** IFB-PAG-004-24: 180' Telescopic Boom Lift

To Whom It May Concern:

Good evening.

Morrice Equipment submits

Acknowledgement Receipt Form

For IFB-PAG-004-24 180' Telescopic Boom Lift

As per bid instruction.

Please confirm receipt.

Thank you.

**Patrick Mafnas Chargualaf**  
Generator And Equipment Sales  
Office: 671.649.1946  
Mobile: 671.688.0309



197 Ypao Road, Tamuning Guam 96913  
671.649.1946  
morricequipment.com



ORIGINAL

This message and any attachments are intended only for the use of the addressee and may contain information that is privileged and confidential.

If the reader of the message is not the intended recipient or an authorized representative of the intended recipient, you are hereby notified

that any dissemination of this communication is strictly prohibited. If you have received this communication in error, please notify us immediately

by e-mail and delete the message and any attachments from your system.

ORIGINAL

INVITATION FOR BID

*Rory Respicio*

RORY J. RESPICIO  
GENERAL MANAGER

ISSUING OFFICE:  
PORT AUTHORITY OF GUAM  
GOVERNMENT OF GUAM  
1026 CABRAS HIGHWAY, SUITE 201,  
PITI, GUAM 96915

DATE ISSUED: January 26, 2024

BID INVITATION NO: IFB/PAG-004-24

BID FOR: **180' Telescopic Boom Lift**

SPECIFICATION: **SEE BELOW**

DESTINATION: **PORT AUTHORITY OF GUAM**

REQUIRED DELIVERY DATE: (460 days ARO) upon receipt of purchase order. Delivery schedule time and quantity will be coordinated between the successful bidder and the requesting department in accordance with the schedules contained in MARAD FY2022 American Marine Highway (AMH) Grant No. 693JF72340007, and in accordance with the expiration date of this grant, currently set to expire on May 1, 2026. This project is funded by the MARAD FY2022 American Marine Highway (AMH) Grant No.: 693JF72340007.

INSTRUCTION TO BIDDERS:

INDICATE WHETHER:  INDIVIDUAL  PARTNERSHIP  CORPORATION  Limited Liability

INCORPORATED IN: Guam Corporation

Each bid shall be submitted in duplicate with electronic copy (pdf format) on CD or thumb drive and sealed inside the envelope when submitting to the issuing office above no later than (Time) **2:00 PM** Date: **FRIDAY, February 16, 2024** and shall be publicly opened. Any bid submitted after the time and date specified above shall be rejected. See attached General Terms and Conditions, and Sealed Bid Solicitation for details.

The undersigned offers and agrees to furnish within the time specified, the articles and services at the price stated opposite the respective items listed on the schedule provided, unless otherwise specified by the bidder. In consideration to the expense of the Government in opening, tabulating, and evaluating this and other bids, and other considerations, the undersigned agrees that this bid remain firm and irrevocable within **90** calendar days from the date opening to supply any or all the items which prices are quoted.

NAME AND ADDRESS OF BIDDER:

SIGNATURE AND TITLE OF PERSON  
AUTHORIZED TO SIGN THIS BID:

**MORRICO**  
EQUIPMENT  
Sales, Rental, Parts and Service  
197 Ypao Road Tamuning, Guam 96913  
Tel: 649-1946 Fax: 649-1947  
Website: [www.morricequipment.com](http://www.morricequipment.com)

*Jesse Munoz*  
Jesse Munoz, Heavy Equipment Sales Manager

AWARD: CONTRACT NO. \_\_\_\_\_ AMOUNT: \_\_\_\_\_ DATE: \_\_\_\_\_

ITEM NO(S) AWARDED: \_\_\_\_\_

CONTRACTING OFFICER:

RORY J. RESPICIO  
GENERAL MANAGER

NAME AND ADDRESS OF CONTRACTOR:

SIGNATURE AND TITLE OF PERSON  
AUTHORIZED TO SIGN THIS CONTRACT:

\_\_\_\_\_  
\_\_\_\_\_

\_\_\_\_\_

**SPECIAL PROVISIONS**

**Contract Period:**

The term of this contract will continue until the expiration of the grant funds under MARAD FY2022 American Marine Highway (AMH) Grant No.: 693JF72340007 and may be extended if the period of performance for the grant funds is extended in accordance with the federal award terms and conditions. The current expiration date of the grant funds is May 1, 2026.

The initial purchase of one (1) 180' Telescopic Boom Lift is funded by MARAD FY2022 American Marine Highway (AMH) Grant No. 693JF72340007

Contract incorporates all applicable provision of the Port Authority of Guam Federal Contract Supplement, and is attached as Exhibit A on pages 54-68 of this IFB.

ORIGINAL

**GOVERNMENT OF GUAM**

THE PORT AUTHORITY OF GUAM  
1026 Cabras Highway, Suite 201  
Piti, Guam 96915

Bond No.: CIC-SUBID24-1001

**BID BOND**

NO. IFB PAG-004-24

KNOW ALL MEN BY THESE PRESENTS that MORRICO EQUIPMENT, LLC, as Principal hereinafter called the Principal, and (Bonding Company), Century Insurance Company (Guam), Ltd. A duly admitted insurer under the laws of the Territory of Guam, as Surety, hereinafter called the Surety are Held firmly bound unto the Territory of Guam for the sum of 15% of Bid Amount Dollars (\$ 15% of Bid Amount ), for Payment of which sum will and truly to be made, the said Principal and the said Surety bind ourselves, our heirs, executors, administrators, successors and assigns, jointly and severally, firmly by these presents.

WHEREAS, the Principal has submitted a bid for (identify project by number and brief description)

IFB PAG-004-24 Bid for 180' Telescopic Boom Lift

NOW, THEREFORE, if the Territory of Guam shall accept the bid of the Principal and the Principal shall enter into a Contract with the Territory of Guam in accordance with the terms of such bid, and give such bond or bonds as may be specified in bidding or Contract Documents with good and sufficient surety for the faithful performance of such Contract and for the prompt payment of labor and material furnished in the prosecution thereof, or in the event of the failure of the Principal to enter such Contract and give such bond or bonds, if the Principal shall pay to the Territory of Guam the difference not to exceed the penalty hereof between the amounts specified in said bid and such larger amount for which the Territory of Guam may in good faith contract with another party to perform work covered by said bid or an appropriate liquidated amount as specified in the Invitation for Bids then this obligation shall be null and void, otherwise to remain full force and effect.

Signed and sealed this \_\_\_\_\_ day of \_\_\_\_\_ 2024

Morrigo Equipment, LLC  
(PRINCIPAL) (SEAL)

Percival DLG Acejo  
(WITNESS)

Senior Account Broker  
(TITLE)

Cornelio L. Matanguihan  
(MAJOR OFFICER OF SURETY)

General Manager - Century Insurance Company (Guam), Ltd.  
(TITLE)

Kevin K. Ward  
(MAJOR OFFICER OF SURETY)

Director and VP - Century Insurance Company (Guam), Ltd.  
(TITLE)  
Assurance Brokers, Inc. dba AB RISK SOLUTIONS  
(RESIDENT GENERAL AGENT)

ORIGINAL



GOVERNMENT OF GUAM  
DEPARTMENT OF REVENUE AND TAXATION  
OFFICE OF THE BANKING AND INSURANCE COMMISSIONER  
**CERTIFICATE OF AUTHORITY**  
RENEWAL COA372

Know All Men By These Presents That:

Name **CENTURY INSURANCE CO (GUAM) LTD**

Address 219 SOUTH MARINE CORP DRIVE  
TAMUNING, GU 96913

STE 102 CENTURY PLAZA BUILDING

Classes of Insurance Authorized }  
Accident & Health  
Fidelity & Surety  
Fire  
Marine  
Miscellaneous

Motor Vehicle  
Prop. Damage & Liability  
Workmens Comp

Having complied with the Insurance Law of Guam, is hereby authorized to transact as an insurer, the above named Classes of Insurance in Guam from the **1st** day of **July, 2023** to the **1st** day of **July, 2024** unless authority is revoked for failure to comply with the law.

General Agent(s):  
ASSURANCE BROKERS INC. (GUAM)DBA AB RISK SOLUTIONS  
CENTURY INSURANCE CO (GUAM) LTD

In Witness Whereof, I have hereunto subscribed my name officially and have hereon impressed my Seal of Office at the City of Hagaña, Guam on this **1st** day of **July, 2023**

*Antonio Soriano*  
*phipwaw*  
*2/18/23*

*Michelle B. Santos*  
**MICHELLE B. SANTOS**  
Banking & Insurance Commissioner

ORIGINAL

**INSTRUCTION TO PROVIDERS:**

NOTICE to all Insurance and Bonding Institutions:

The Bond requires the signatures of the Vendor, two (2) major Officers of the Surety and Resident General Agent, if the Surety is a foreign or alien surety.

When the form is submitted to THE PORT AUTHORITY OF GUAM, it should be accompanied with copies of  
The following:

1. Current Certificate of Authority to do business on Guam issued by the Department of Revenue and Taxation.
2. Power of Attorney issued by the Surety to the Resident General Agent.
3. Power of Attorney issued by two (2) major officers of the Surety to whoever is signing on their behalf.

Bonds, submitted as Bid Guarantee, without signatures and supporting documents are invalid and Bids will be rejected.

ORIGINAL

**DECLARATION RE: ETHICAL STANDARDS**  
**(AG Form 005)**

Jesse Munoz [state name of declarant signing below], hereby declares that:

The declarant is an officer of the Offeror [state one of the following: *the Bidder/Offeror, a partner of the Bidder/Offeror, an officer of the Bidder/Offeror*] making the foregoing identified bid or proposal. To the best of declarant's knowledge, neither declarant nor any officers, representatives, agents, subcontractors or employees of bidder/offeror have knowingly influenced any government of Guam employee to breach any of the ethical standards set forth in 5 GCA Chapter 5, Article 11. Further, declarant promises that neither he or she, nor any officer, representative, agent, subcontractor, or employee of bidder/offeror will knowingly influence any government of Guam employee to breach any ethical standards set forth in 5 GCA Chapter 5, Article 11. These statements are made pursuant to 5GCA §§ 5626, 5628 through 5633; and 2 GAR Division 4 § 11103(b).

I hereby declare under penalty of perjury under the laws of Guam that the foregoing is true and correct.

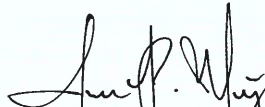

Jesse Munoz, Heavy Equipment Manager

Signature of one of the following:

Bidder/ Offeror, if the bidder/offeror is an individual; Partner, if the bidder/offeror is a partnership; Officer, if the bidder/offeror is a corporation.

**DECLARATION RE: NO GRATUITIES or KICKBACKS**  
(AG Form 004)

Jesse Munoz [state name of declarant signing below], hereby declare that:

1. The name of the offering firm or individual is Morrigo Equipment LLC [state name of bidder/offeror company] Declarant is an officer of the Offeror [state one of the following: the bidder/offeror, a partner of the bidder/offeror, an officer of the bidder/offeror] making the foregoing identified bid or proposal.

2. To the best of declarant's knowledge, neither declarant, nor any of the bidder's/offeror's officers, representatives, agents, subcontractors, or employees have violated, are violating the prohibition against gratuities and kickbacks set forth in 2 GAR Division 4 § 11107(e). Further, affiant promises, on behalf of bidder/offeror, not to violate the prohibition against gratuities and kickbacks as set forth in 2 GAR Division 4 § 11107(e).

3. To the best of declarant's knowledge, neither declarant, nor any of the bidders/offerors officers, representatives, agents, subcontractors, or employees have offered, given or agreed to give, any government of Guam employee or former government employee, any payment, gift, kickback, gratuity or offer of employment in connection with the bidders/offerors bid or proposal.

4. I make these statements on behalf of myself as a representative of the bidder/offeror, and on behalf of the bidder/offeror's officers, representatives, agents, subcontractors, and employees.

I hereby declare under penalty of perjury under the laws of Guam that the foregoing is true and correct.

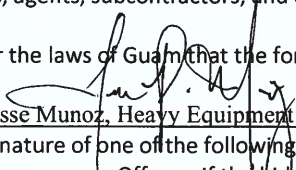
  
Jesse Munoz, Heavy Equipment Sales Manager  
Signature of one of the following:

- Offeror, if the bidder/offeror is an individual;
- Partner, if the bidder/offeror is a partnership;
- Officer, if the bidder/offeror is a corporation.

**SPECIAL PROVISIONS**

**RESTRICTION AGAINST SEX OFFENDERS EMPLOYED BY SERVICES PROVIDERS TO GOVERNMENT OF GUAM FROM WORKING ON GOVERNMENT PROPERTY**

If a contract for services is awarded to the bidder or offeror, then the service provider must warranty that no person in its employment who has been convicted of a sex offense under the provisions of chapter 25 of Title 9 of Guam code Annotated or of an offense defined in Article 2 of chapter 28 of Title 9 of the Guam Code annotated, or who has been convicted in any other jurisdiction of an offense with the same elements as heretofore defined, or who is listed on the Sex Offender Registry, shall provide services on behalf of the service provider while on government of Guam property, with the exception of public highways. If any employee of a service provider is providing services on government property and is convicted subsequent to an award of a contract, then the service provider warrants that it will notify the Government of the conviction within twenty-four (24) hours of the conviction, and will immediately remove such convicted person from providing services on government property. If the service provider is found to be in violation of any of the provisions of this paragraph, then the government will give notice to the service provider to take corrective action. The service provider shall take corrective action within twenty-four (24) hours of notice from the Government, and the service provider shall notify the Government when action has been taken. If the service providers fail to take corrective steps within twenty-four (24) hours of notice from the Government, then the Government in its sole discretion may suspend temporarily and contract for services until corrective action has been taken.

Jesse Munoz, Heavy Equipment Sales Manager

Signature of Bidder

Proposer, if an individual;  
Partner, if a partnership;  
Officer, if a corporation.

Feb 15, 2024  
Date

ORIGINAL

**DECLARATION RE COMPLIANCE WITH U.S. D.O.L. WAGE DETERMINATION**

Procurement No: IFB PAG-004-24 180' Telescopic Boom Lift

Name of Offeror Company: Morrico Equipment hereby certifies under penalty of perjury:

- (1) That I am an officer of the Offeror (the offeror, a partner of the offeror, an officer of the offeror) making the bid or proposal in the foregoing identified procurement;
- (2) That I have read and understand the provisions of 5 GCA § 5801 and § 5802 which read:

**§ 5801. Wage Determination Established.**

In such cases where the government of Guam enters into contractual arrangements with a sole proprietorship, a partnership or a corporation ("contractor") for the provision of a service to the government of Guam, and in such cases where the contractor employs a person(s) whose purpose, in whole or in part, is the direct delivery of service contracted by the government of Guam, then the contractor shall pay such employee(s) in accordance with the Wage Determination for Guam and the Northern Mariana Islands issued and promulgated by the U.S. Department of Labor for such labor as is employed in the direct delivery of contract deliverables to the government of Guam.

The Wage Determination most recently issued by the U.S. Department of Labor at the time a contract is awarded to a contractor by the government of Guam shall be used to determine wages, which shall be paid to employees pursuant to this Article. Should any contract contain a renewal clause, then at the time of renewal adjustments, there shall be made stipulations contained in that contract for applying the Wage Determination, as required by this Article, so that the Wage Determination promulgated by the U.S. Department of Labor on a date most recent to the renewal date shall apply.

**§ 5802. Benefits.**

In addition to the Wage Determination detailed in this Article, any contract to which this Article applies shall also contain provisions mandating health and similar benefits for employees covered by this Article, such benefits having a minimum value as detailed in the Wage Determination issued and promulgated by the U.S. Department of Labor, and shall contain provisions guaranteeing a minimum of ten (10) paid holidays per annum per employee.

- (3) That the offeror is in full compliance with 5 GCA § 5801 and § 5802, as may be applicable to the procurement referenced herein;
- (4) That I have attached the most recent wage determination applicable to Guam issued by the U.S. Department of Labor. [INSTRUCTIONS – Please attach]

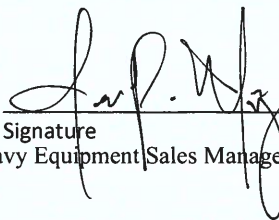
  
Signature \_\_\_\_\_ Date Feb 15, 2024  
Jesse Munoz, Heavy Equipment Sales Manager

ORIGINAL

"REGISTER OF WAGE DETERMINATIONS  
UNDER THE SERVICE CONTRACT ACT  
By direction of the Secretary of Labor

Daniel W. Simms, Division of  
Director Wage Determinations

U.S. DEPARTMENT OF LABOR  
EMPLOYMENT STANDARDS ADMINISTRATION  
WAGE AND HOUR DIVISION  
WASHINGTON D.C. 20210

Wage Determination No.: 2015-5693  
Revision No.: 19 | Date of Last Revision: 07/17/2023

Note: Contracts subject to the Service Contract Act are generally required to pay at least the applicable minimum wage rate required under Executive Order 14026. If the contract is entered into on or after January 30 2022 or the contract is renewed or extended (e.g., an option is exercised) on or after January 30 2022: The contractor must pay all covered workers at least \$16.20 per hour (or the applicable wage rate listed on this wage determination if it is higher) for all hours spent performing on the contract in 2023.

The applicable Executive Order minimum wage rate will be adjusted annually. Additional information on contractor requirements and worker protections under the Executive Orders is available at <https://www.dol.gov/agencies/whd/government-contracts>.

States: Guam Northern Marianas Wake Island  
Area: Guam Statewide  
Northern Marianas Statewide  
Wake Island Statewide

\*\*Fringe Benefits Required Follow the Occupational Listing\*\*

OCCUPATION CODE - TITLE	FOOTNOTE RATE	OCCUPATION CODE - TITLE	FOOTNOTE RATE
-------------------------	---------------	-------------------------	---------------

ORIGINAL

01000 - Administrative Support And Clerical Occupations		09000 - Furniture Maintenance And Repair Occupations	
01011 - Accounting Clerk I	14.27***	09010 - Electrostatic Spray Painter	18.75
01012 - Accounting Clerk II	16.02***	09040 - Furniture Handler	11.37***
01013 - Accounting Clerk III	17.93	09080 - Furniture Refinisher	18.75
01020 - Administrative Assistant	21.43	09090 - Furniture Refinisher Helper	13.77***
01035 - Court Reporter	17.40	09110 - Furniture Repairer, Mi	16.32
01041 - Customer Service Representative I	12.75***	09130 - Upholsterer	18.75
01042 - Customer Service Representative II	14.23***	11000 - General Services And Support Occupations	
01043 - Customer Service Representative III	15.62***	11030 - Cleaner, Vehicles	9.69***
01051 - Data Entry Operator I	12.16***	11060 - Elevator Operator	9.69***
01052 - Data Entry Operator II	13.27***	11090 - Gardener	14.28***
01060 - Dispatcher, Motor Vehicle	17.39	11122 - Housekeeping Aide	10.13***
01070 - Document Preparation Clerk	13.85***	11150 - Janitor	10.13***
01090 - Duplicating Machine Operator	13.85***	11210 - Laborer, Grounds Maintenance	10.79***
01111 - General Clerk I	11.33***	11240 - Maid or Houseman	9.67***
01112 - General Clerk II	12.36***	11260 - Pruner	9.66***
01113 - General Clerk III	13.88***	11270 - Tractor Operator	13.07***
01120 - Housing Referral Assistant	19.39	11330 - Trail Maintenance Worker	10.79***
01141 - Messenger Courier	11.37***	01612 - Word Processor II	16.31
01191 - Order Clerk I	12.57***	11360 - Window Cleaner	11.32***
01192 - Order Clerk II	13.71***	12000 - Health Occupations	
01261 - Personnel Assistant (Employment) I	15.95***	12010 - Ambulance Driver	18.96
01262 - Personnel Assistant (Employment) II	17.85	12011 - Breath Alcohol Technician	18.96
01263 - Personnel Assistant (Employment) III	19.89	12012 - Certified Occupational Therapist Assistant	26.02
01270 - Production Control Clerk	22.97	12015 - Certified Physical Therapist Assistant	26.02
01290 - Rental Clerk	11.10***	12020 - Dental Assistant	18.79
01300 - Scheduler, Maintenance	15.55***	12025 - Dental Hygienist	39.73
01311 - Secretary I	15.55***	12030 - EKG Technician	28.73
01312 - Secretary II	17.40	12035 - Electroneurodiagnostic Technologist	28.73
01313 - Secretary III	19.39	12040 - Emergency Medical Technician	18.96
01320 - Service Order Dispatcher	15.40***	12071 - Licensed Practical Nurse I	16.95
01410 - Supply Technician	21.43	12072 - Licensed Practical Nurse II	18.96
01420 - Survey Worker	16.96	12073 - Licensed Practical Nurse III	21.14
01460 - Switchboard Operator/Receptionist	10.78***	12100 - Medical Assistant	13.42***
01531 - Travel Clerk I	13.01***	12130 - Medical Laboratory Technician	18.82
01532 - Travel Clerk II	14.12***	12160 - Medical Record Clerk	14.97***
01533 - Travel Clerk III	15.09***	12190 - Medical Record Technician	17.77
01611 - Word Processor I	14.53***	12195 - Medical Transcriptionist	16.95
		12210 - Nuclear Medicine Technologist	41.68
01613 - Word Processor III	18.26	12221 - Nursing Assistant I	12.43***
05000 - Automotive Service Occupations		12222 - Nursing Assistant II	13.97***
05005 - Automobile Body Repairer, Fiberglass	17.20	12223 - Nursing Assistant III	15.24***
05010 - Automotive Electrician	16.16***	12224 - Nursing Assistant IV	17.12
05040 - Automotive Glass Installer	15.11***	12235 - Optical Dispenser	18.96
05070 - Automotive Worker	15.11***	12236 - Optical Technician	16.95
05110 - Mobile Equipment Servicer	12.96***	12250 - Pharmacy Technician	15.49***
05130 - Motor Equipment Metal Mechanic	17.20	12280 - Phlebotomist	16.95
05160 - Motor Equipment Metal Worker	15.11***	12305 - Radiologic Technologist	28.73
05190 - Motor Vehicle Mechanic	17.20	12311 - Registered Nurse I	23.50
05220 - Motor Vehicle Mechanic Helper	11.87***	12312 - Registered Nurse II	28.73
05250 - Motor Vehicle Upholstery Worker	14.06***	12313 - Registered Nurse II, Specialist	28.73
05280 - Motor Vehicle Wrecker	15.11***	12314 - Registered Nurse III	34.76
05310 - Painter, Automotive	16.16***	12315 - Registered Nurse III, Anesthetist	34.76
05340 - Radiator Repair Specialist	15.11***	12316 - Registered Nurse IV	41.68
05370 - Tire Repairer	12.67***	12317 - Scheduler (Drug and Alcohol Testing)	23.50
05400 - Transmission Repair Specialist	17.20	12320 - Substance Abuse Treatment Counselor	23.50
07000 - Food Preparation And Service Occupations		13000 - Information And Arts Occupations	
07010 - Baker	11.10***	13011 - Exhibits Specialist I	21.42
07041 - Cook I	14.44***	13012 - Exhibits Specialist II	26.53
07042 - Cook II	16.84	13013 - Exhibits Specialist III	32.45
07070 - Dishwasher	9.69***	13041 - Illustrator I	21.42
07130 - Food Service Worker	10.11***	13042 - Illustrator II	26.53
07210 - Meat Cutter	13.34***	13043 - Illustrator III	32.45
07260 - Waiter/Waitress	9.73***		

ORIGINAL



OCCUPATION CODE - TITLE	FOOTNOTE RATE
13047 - Librarian	29.38
13050 - Library Aide/Clerk	17.05
13054 - Library Information Technology Systems Administrator	26.53
13058 - Library Technician	18.11
13061 - Media Specialist I	19.15
13062 - Media Specialist II	21.42
13063 - Media Specialist III	23.87
13071 - Photographer I	19.15
13072 - Photographer II	21.42
13073 - Photographer III	26.53
13074 - Photographer IV	32.45
13075 - Photographer V	39.27
13090 - Technical Order Library Clerk	21.42
13110 - Video Teleconference Technician	19.15
14000 - Information Technology Occupations	
14041 - Computer Operator I	15.71***
14042 - Computer Operator II	17.22
14043 - Computer Operator III	19.19
14044 - Computer Operator IV	21.33
14045 - Computer Operator V	23.62
14071 - Computer Programmer I (see 1)	15.73***
14072 - Computer Programmer II (see 1)	19.50
14073 - Computer Programmer III (see 1)	23.84
14074 - Computer Programmer IV (see 1)	
14101 - Computer Systems Analyst I (see 1)	24.23
14102 - Computer Systems Analyst II (see 1)	
14103 - Computer Systems Analyst III (see 1)	
14150 - Peripheral Equipment Operator	15.71***
14160 - Personal Computer Support Technician	21.33
14170 - System Support Specialist	21.24
15000 - Instructional Occupations	
15010 - Aircrew Training Devices Instructor (Non-Rated)	24.23
15020 - Aircrew Training Devices Instructor (Rated)	29.32
15030 - Air Crew Training Devices Instructor (Pilot)	34.91
15050 - Computer Based Training Specialist / Instructor	24.23
15060 - Educational Technologist	29.40
15070 - Flight Instructor (Pilot)	34.91
15080 - Graphic Artist	20.47
15085 - Maintenance Test Pilot, Fixed, Jet/Prop	34.91
15086 - Maintenance Test Pilot, Rotary Wing	34.91
15088 - Non-Maintenance Test/Co-Pilot	34.91
15090 - Technical Instructor	17.67
15095 - Technical Instructor/Course Developer	23.78
15110 - Test Proctor	15.70***
15120 - Tutor	15.70***
16000 - Laundry, Dry-Cleaning, Pressing And Related Occupations	
16010 - Assembler	10.83***
16030 - Counter Attendant	10.83***
16040 - Dry Cleaner	12.36***
16070 - Finisher, Flatwork, Machine	10.83***
16090 - Presser, Hand	10.83***
16110 - Presser, Machine, Drycleaning	10.83***
16130 - Presser, Machine, Shirts	10.83***
16160 - Presser, Machine, Wearing Apparel, Laundry	10.83***
16190 - Sewing Machine Operator	12.88***
16220 - Tailor	13.40***
16250 - Washer, Machine	11.34***
19000 - Machine Tool Operation And Repair Occupations	
19010 - Machine-Tool Operator (Tool Room)	19.46
19040 - Tool And Die Maker	24.46
21000 - Materials Handling And Packing Occupations	
21020 - Forklift Operator	15.36***
21030 - Material Coordinator	22.97
21040 - Material Expediter	22.97
21050 - Material Handling Laborer	12.57***
21071 - Order Filler	10.62***
21080 - Production Line Worker (Food Processing)	15.36***
21110 - Shipping Packer	17.12
21130 - Shipping/Receiving Clerk	17.12
21140 - Store Worker I	15.83***
21150 - Stock Clerk	22.26
21210 - Tools And Parts Attendant	15.36***
21410 - Warehouse Specialist	15.36***
23000 - Mechanics And Maintenance And Repair Occupations	
23010 - Aerospace Structural Welder	25.04
23019 - Aircraft Logs and Records Technician	19.47
23021 - Aircraft Mechanic I	23.84
23022 - Aircraft Mechanic II	25.04
23023 - Aircraft Mechanic III	26.30
23040 - Aircraft Mechanic Helper	16.58
23050 - Aircraft, Painter	22.39
23060 - Aircraft Servicer	19.47
23070 - Aircraft Survival Flight Equipment Technician	22.39
23080 - Aircraft Worker	21.03
23091 - Aircrew Life Support Equipment (ALSE) Mechanic I	21.03
23092 - Aircrew Life Support Equipment (ALSE) Mechanic II	23.84

OCCUPATION CODE - TITLE FOOTNOTE RATE

OCCUPATION CODE - TITLE	FOOTNOTE RATE	RAT
23110 - Appliance Mechanic	19.46	
23120 - Bicycle Repairer	15.61***	
23125 - Cable Splicer	22.47	
23130 - Carpenter, Maintenance	17.58	
23140 - Carpet Layer	18.20	
23160 - Electrician, Maintenance	19.37	
23181 - Electronics Technician Maintenance I	18.20	
23182 - Electronics Technician Maintenance II	19.46	
23183 - Electronics Technician Maintenance III	20.72	
23260 - Fabric Worker	16.94	
23290 - Fire Alarm System Mechanic	16.77	
23310 - Fire Extinguisher Repairer	15.61***	
23311 - Fuel Distribution System Mechanic	20.72	
23312 - Fuel Distribution System Operator	15.61***	
23370 - General Maintenance Worker	13.24***	
23380 - Ground Support Equipment Mechanic	23.84	
23381 - Ground Support Equipment Servicer	19.47	
23382 - Ground Support Equipment Worker	21.03	
23391 - Gunsmith I	15.61***	
23392 - Gunsmith II	18.20	
23393 - Gunsmith III	20.72	
23410 - Heating, Ventilation And Air-Conditioning Mechanic	19.27	
23411 - Heating, Ventilation And Air Conditioning Mechanic (Research Facility)	20.50	
23430 - Heavy Equipment Mechanic	19.50	
23440 - Heavy Equipment Operator	18.10	
23460 - Instrument Mechanic	20.72	
23465 - Laboratory/Shelter Mechanic	19.46	
23470 - Laborer	12.57***	
23510 - Locksmith	19.46	
23530 - Machinery Maintenance Mechanic	23.13	
23550 - Machinist, Maintenance	20.72	
23580 - Maintenance Trades Helper	11.77***	
23591 - Metrology Technician I	20.72	
23592 - Metrology Technician II	22.03	
23593 - Metrology Technician III	23.33	
23640 - Millwright	20.72	
23710 - Office Appliance Repairer	19.46	
23760 - Painter, Maintenance	17.04	
23790 - Pipefitter, Maintenance	19.96	
23810 - Plumber, Maintenance	18.75	
23820 - Pneudraulic Systems Mechanic	20.72	
23850 - Rigger	20.72	
23870 - Scale Mechanic	18.20	
23890 - Sheet-Metal Worker, Maintenance	19.55	
23910 - Small Engine Mechanic	18.20	
23931 - Telecommunications Mechanic I	19.96	
23932 - Telecommunications Mechanic II	21.24	
23950 - Telephone Lineman	20.62	
23960 - Welder, Combination, Maintenance	19.96	
23965 - Well Driller	21.13	
23970 - Woodcraft Worker	20.71	
23980 - Woodworker	15.61***	
24000 - Personal Needs Occupations		
24550 - Case Manager	15.01***	
24570 - Child Care Attendant	10.09***	
24580 - Child Care Center Clerk	13.25***	
24610 - Chore Aide	14.06***	
24620 - Family Readiness And Support Services Coordinator	15.01***	
24630 - Homemaker	16.12***	
25000 - Plant And System Operations Occupations		
25010 - Boiler Tender	22.79	
25040 - Sewage Plant Operator	22.89	
25070 - Stationary Engineer	22.79	
25190 - Ventilation Equipment Tender	15.72***	
25210 - Water Treatment Plant Operator	22.89	
27000 - Protective Service Occupations		
27004 - Alarm Monitor	10.90***	
27007 - Baggage Inspector	9.63***	
27008 - Corrections Officer	14.59***	
27010 - Court Security Officer	14.59***	
27030 - Detection Dog Handler	10.90***	
27040 - Detention Officer	14.59***	
27070 - Firefighter	14.59***	
27101 - Guard I	9.63***	
27102 - Guard II	10.90***	
27131 - Police Officer I	14.59***	
27132 - Police Officer II	16.21	
28000 - Recreation Occupations		
28041 - Carnival Equipment Operator	13.24***	
28042 - Carnival Equipment Repairer	14.46***	
28043 - Carnival Worker	9.78***	
28210 - Gate Attendant/Gate Tender	13.18***	

OCCUPATION CODE - TITLE FOOTNOTE RATE

ORIGINAL

28310 - Lifeguard	11.01***	
28350 - Park Attendant (Aide)	14.74***	
28510 - Recreation Aide/Health Facility Attendant	11.84***	
28515 - Recreation Specialist	18.26	
29000 - Stevedoring/Longshoremen Occupational Services		
29010 - Blocker And Bracer	26.02	
29020 - Hatch Tender	26.02	
29030 - Line Handler	26.02	
29041 - Stevedore I	24.21	
29042 - Stevedore II	27.82	
30000 - Technical Occupations		
30010 - Air Traffic Control Specialist, Center (HFO) (see 2)	43.06	
30011 - Air Traffic Control Specialist, Station (HFO) (see 2)	29.69	
30012 - Air Traffic Control Specialist, Terminal (HFO) (see 2)	32.70	
30021 - Archeological Technician I	18.17	
30022 - Archeological Technician II	20.33	
30023 - Archeological Technician III	25.19	
30030 - Cartographic Technician	25.19	
30040 - Civil Engineering Technician	25.19	
30051 - Cryogenic Technician I	27.89	
30052 - Cryogenic Technician II	30.80	
30061 - Drafter/CAD Operator I	18.17	
30062 - Drafter/CAD Operator II	20.33	
30063 - Drafter/CAD Operator III	22.66	
30064 - Drafter/CAD Operator IV	27.89	
30081 - Engineering Technician I	16.19***	
30082 - Engineering Technician II	18.17	
30083 - Engineering Technician III	20.33	
30084 - Engineering Technician IV	25.19	
30085 - Engineering Technician V	30.80	
30086 - Engineering Technician VI	37.27	
30090 - Environmental Technician	25.19	
30095 - Evidence Control Specialist	25.19	
30210 - Laboratory Technician	22.66	
30221 - Latent Fingerprint Technician I	27.89	
30222 - Latent Fingerprint Technician II	30.80	
30240 - Mathematical Technician	25.19	
30361 - Paralegal/Legal Assistant I	19.54	
30362 - Paralegal/Legal Assistant II	24.21	
30363 - Paralegal/Legal Assistant III	29.61	
30364 - Paralegal/Legal Assistant IV	35.83	
30375 - Petroleum Supply Specialist	30.80	
30390 - Photo-Optics Technician	24.92	
30395 - Radiation Control Technician	30.80	
30461 - Technical Writer I	25.19	
30462 - Technical Writer II	30.80	
30463 - Technical Writer III	37.27	
30491 - Unexploded Ordnance (UXO) Technician I	27.37	
30492 - Unexploded Ordnance (UXO) Technician II	33.11	
30493 - Unexploded Ordnance (UXO) Technician III	39.69	
30494 - Unexploded (UXO) Safety Escort	27.37	
30495 - Unexploded (UXO) Sweep Personnel	27.37	
30501 - Weather Forecaster I	27.89	
30502 - Weather Forecaster II	33.93	
30620 - Weather Observer, Combined Upper Air Or Surface Programs (see 2)	22.66	
30621 - Weather Observer, Senior (see 2)	25.19	
31000 - Transportation/Mobile Equipment Operation Occupations		
31010 - Airplane Pilot	33.11	
31020 - Bus Aide	8.97***	
31030 - Bus Driver	11.73***	
31043 - Driver Courier	10.26***	
31260 - Parking and Lot Attendant	9.91***	
31290 - Shuttle Bus Driver	11.65***	
31310 - Taxi Driver	11.41***	
31361 - Truckdriver, Light	11.21***	
31362 - Truckdriver, Medium	12.16***	
31363 - Truckdriver, Heavy	16.11***	
31364 - Truckdriver, Tractor-Trailer	16.11***	
99000 - Miscellaneous Occupations		
99020 - Cabin Safety Specialist	16.14***	
99030 - Cashier	10.01***	
99050 - Desk Clerk	9.71***	
99095 - Embalmer	27.37	
99130 - Flight Follower	27.37	
99251 - Laboratory Animal Caretaker I	24.31	
99252 - Laboratory Animal Caretaker II	26.56	
99260 - Marketing Analyst	21.54	
99310 - Mortician	27.37	
99410 - Pest Controller	16.07***	
99510 - Photofinishing Worker	14.38***	
99710 - Recycling Laborer	17.32	
99711 - Recycling Specialist	23.38	
99730 - Refuse Collector	16.40	
99810 - Sales Clerk	10.63***	
99820 - School Crossing Guard	17.96	
99830 - Survey Party Chief	23.99	
99831 - Surveying Aide	13.65***	
99832 - Surveying Technician	17.73	
99840 - Vending Machine Attendant	24.31	
99841 - Vending Machine Repairer	30.96	

\*\*\*Workers in this classification may be entitled to a higher minimum wage under Executive Order 14026 (\$16.20 per hour). Please see the Note at the top of the wage determination for more information. Please also note that the minimum wage requirements of Executive Order 14026 are not currently being enforced as to contracts or contract-like instruments entered into with the federal government in connection with seasonal recreational services or seasonal recreational equipment rental for the general public on federal lands.

ALL OCCUPATIONS LISTED ABOVE RECEIVE THE FOLLOWING BENEFITS:

HEALTH & WELFARE: \$4.98 per hour, up to 40 hours per week, or \$199.20 per week or \$863.20 per month

HEALTH & WELFARE EO 13706: \$4.57 per hour, up to 40 hours per week, or \$182.80 per week, or \$792.13 per month\*

\*This rate is to be used only when compensating employees for performance on an SCA-covered contract also covered by EO 13706, Establishing Paid Sick Leave for Federal Contractors. A contractor may not receive credit toward its SCA obligations for any paid sick leave provided pursuant to EO 13706.

VACATION: 2 weeks paid vacation after 1 year of service with a contractor or successor; and 4 weeks after 3 years. Length of service includes the whole span of continuous service with the present contractor or successor, wherever employed, and with the predecessor contractors in the performance of similar work at the same Federal facility. (Reg. 29 CFR 4.173) HOLIDAYS: A minimum of eleven paid holidays per year: New Year's Day, Martin Luther King Jr.'s Birthday, Washington's Birthday, Memorial Day, Juneteenth National Independence Day, Independence Day, Labor Day, Columbus Day, Veterans' Day, Thanksgiving Day, and Christmas Day. (A contractor may substitute for any of the named holidays another day off with pay in accordance with a plan communicated to the employees involved.) (See 29 CFR 4.174)

ORIGINAL

THE OCCUPATIONS WHICH HAVE NUMBERED FOOTNOTES IN PARENTHESES RECEIVE THE FOLLOWING:

1) **COMPUTER EMPLOYEES:** This wage determination does not apply to any individual employed in a bona fide executive, administrative, or professional capacity, as defined in 29 C.F.R. Part 541. (See 41 C.F.R. 6701(3)). Because most Computer Systems Analysts and Computer Programmers who are paid at least \$27.63 per hour (or at least \$684 per week if paid on a salary or fee basis) likely qualify as exempt computer professionals under 29 U.S.C. 213(a)(1) and 29 U.S.C. 213(a)(17), this wage determination may not include wage rates for all occupations within those job families. In such instances, a conformance will be necessary if there are nonexempt employees in these job families working on the contract.

Job titles vary widely and change quickly in the computer industry, and are not determinative of whether an employee is an exempt computer professional. To be exempt, computer employees who satisfy the compensation requirements must also have a primary duty that consists of:

(1) The application of systems analysis techniques and procedures, including consulting with users, to determine hardware, software or system functional specifications;

(2) The design, development, documentation, analysis, creation, testing or modification of computer systems or programs, including prototypes, based on and related to user or system design specifications;

(3) The design, documentation, testing, creation or modification of computer programs related to machine operating systems; or

(4) A combination of the aforementioned duties, the performance of which requires the same level of skills. (29 C.F.R. 541.400).

Any computer employee who meets the applicable compensation requirements and the above duties test qualifies as an exempt computer professional under both section 13(a)(1) and section 13(a)(17) of the Fair Labor Standards Act. (Field Assistance Bulletin No. 2006-3 (Dec. 14, 2006)). Accordingly, this wage determination will not apply to any exempt computer employee regardless of which of these two exemptions is utilized.

2) **AIR TRAFFIC CONTROLLERS AND WEATHER OBSERVERS - NIGHT PAY & SUNDAY PAY:** If you work at night as part of a regular tour of duty, you will earn a night differential and receive an additional 10% of basic pay for any hours worked between 6pm and 6am. If you are a full-time employed (40 hours a week) and Sunday is part of your regularly scheduled workweek, you are paid at your rate of basic pay plus a Sunday premium of 25% of your basic rate for each hour of Sunday work which is not overtime (i.e.: occasional work on Sunday outside the normal tour of duty is considered overtime work).

**\*\* HAZARDOUS PAY DIFFERENTIAL \*\***

An 8 percent differential is applicable to employees employed in a position that represents a high degree of hazard when working with or in close proximity to ordnance, explosives, and incendiary materials. This includes work such as screening, blending, dyeing, mixing, and pressing of sensitive ordnance, explosives, and pyrotechnic compositions such as lead azide, black powder and photoflash powder. All dry-house activities involving propellants or explosives. Demilitarization, modification, renovation, demolition, and maintenance operations on sensitive ordnance, explosives and incendiary materials. All operations involving re-grading and cleaning of artillery ranges.

A 4 percent differential is applicable to employees employed in a position that represents a low degree of hazard when working with, or in close proximity to ordnance, (or employees possibly adjacent to) explosives and incendiary materials which involves potential injury such as laceration of hands, face, or arms of the employee engaged in the operation, irritation of the skin, minor burns and the like; minimal damage to immediate or adjacent work area or equipment being used. All operations involving, unloading, storage, and hauling of ordnance, explosive, and incendiary ordnance material other than small arms ammunition. These differentials are only applicable to work that has been specifically designated by the agency for ordnance, explosives, and incendiary material differential pay.

**\*\* UNIFORM ALLOWANCE \*\***

If employees are required to wear uniforms in the performance of this contract (either by the terms of the Government contract, by the employer, by the state or local law, etc.), the cost of furnishing such uniforms and maintaining (by laundering or dry cleaning) such uniforms is an expense that may not be borne by an employee where such cost reduces the hourly rate below that required by the wage determination. The Department of Labor will accept payment in accordance with the following standards as compliance:

The contractor or subcontractor is required to furnish all employees with an adequate number of uniforms without cost or to reimburse employees for the actual cost of the uniforms. In addition, where uniform cleaning and maintenance is made the responsibility of the employee, all contractors and subcontractors subject to this wage determination shall (in the absence of a bona fide collective bargaining agreement providing for a different amount, or the furnishing of contrary affirmative proof as to the actual cost), reimburse all employees for such cleaning and maintenance at a rate of \$3.35 per week (or \$.67 cents per day). However, in those instances where the uniforms furnished are made of "wash and wear" materials, may be routinely washed and dried with other personal garments, and do not require any special treatment such as dry cleaning, daily washing, or commercial laundering in order to meet the cleanliness or appearance standards set by the terms of the Government contract, by the contractor, by law, or by the nature of the work, there is no requirement that employees be reimbursed for uniform maintenance costs.

**\*\* SERVICE CONTRACT ACT DIRECTORY OF OCCUPATIONS \*\***

The duties of employees under job titles listed are those described in the "Service Contract Act Directory of Occupations", Fifth Edition (Revision 1), dated September 2015, unless otherwise indicated.

**\*\* REQUEST FOR AUTHORIZATION OF ADDITIONAL CLASSIFICATION AND WAGE RATE, Standard Form 1444 (SF-1444) \*\***

Conformance Process: The contracting officer shall require that any class of service employee which is not listed herein and which is to be employed under the contract (i.e., the work to be performed is not performed by any classification listed in the wage determination), be classified by the contractor so as to provide a reasonable relationship (i.e., appropriate level of skill comparison) between such unlisted classifications and the classifications listed in the wage determination (See 29 CFR 4.6(b)(2)(i)). Such conforming procedures shall be initiated by the contractor prior to the performance of contract work by such unlisted class(es) of employees (See 29 CFR 4.6(b)(2)(ii)). The Wage and Hour Division shall make a final determination of conformed classification, wage rate, and/or fringe benefits which shall be paid to all employees performing in the classification from the first day of work on which contract work is performed by them in the classification. Failure to pay such unlisted employees the compensation agreed upon by the interested parties and/or fully determined by the Wage and Hour Division retroactive to the date such class of employees commenced contract work shall be a violation of the Act and this contract. (See 29 CFR 4.6(b)(2)(v)). When multiple wage determinations are included in a contract, a separate SF-1444 should be prepared for each wage determination to which a class(es) is to be confirmed.

The process for preparing a conformance request is as follows:

1) When preparing the bid, the contractor identifies the need for a conformed occupation(s) and computes a proposed rate(s).

2) After contract award, the contractor prepares a written report listing in order the proposed classification title(s), a federal grade equivalency (FGE) for each proposed classification(s), job description(s), and rationale for proposed wage rate(s), including information regarding the agreement or disagreement of the authorized representative of the employees involved, or where there is no authorized representative, the employees themselves. This report should be submitted to the contracting officer no later than 30 days after such unlisted class(es) of employees performs any contract work.

3) The contracting officer reviews the proposed action and promptly submits a report of the action, together with the agency's recommendations and pertinent information including the position of the contractor and the employees, to the U.S. Department of Labor, Wage and Hour Division, for review (See 29 CFR 4.6(b)(2)(iii)).

4) Within 30 days of receipt, the Wage and Hour Division approves, modifies, or disapproves the action via transmittal to the agency contracting officer, or notifies the contracting officer that additional time will be required to process the request.

5) The contracting officer transmits the Wage and Hour Division's decision to the contractor.

ORIGINAL

6) Each affected employee shall be furnished by the contractor with a written copy of such determination or it shall be posted as a part of the wage determination (See 29 CFR 4.6(b)(2)(iii)).

Information required by the Regulations must be submitted on SF-1444 or bond paper.

When preparing a conformance request, the ""Service Contract Act Directory of Occupations"" should be used to compare job definitions to ensure that duties requested are not performed by a classification already listed in the wage determination. Remember, it is not the job title, but the required tasks that determine whether a class is included in an established wage determination. Conformances may not be used to artificially split, combine, or subdivide classifications listed in the wage determination (See 29 CFR 4.152(c)(1))."

**DECLARATION RE: NON-COLLUSION**  
(AG FORM 003)

Jesse Munoz

\_\_\_\_\_ [state name of declarant signing below], declares that:

1. The name of the bidding/offering company or individual is [state name of company]  
Morrico Equipment LLC.

2. The Bid/Proposal for the solicitation identified above is genuine and not collusive or a sham. The bidder/offeree has not colluded, conspired, connived or agreed, directly or indirectly, with any other bidder/offeree or person, to put in a sham bid/proposal or to refrain from making an offer. The bidder/offeree has not in any manner, directly or indirectly, sought by an agreement or collusion, or communication or conference, with any person to fix the proposal price of bidder/offeree or of any other bidder/offeree, or to fix any overhead, profit or cost element of said proposal price, or of that of any other bidder/offeree, or to secure any advantage against the government of Guam or any other bidder/offeree, or to secure any advantage against the government of Guam or any person interested in the proposed contract. All statements in this affidavit and in the proposal are true to the best of the knowledge of the undersigned. This statement is made pursuant to 2 GAR Division 4 § 3126(b).

3. I make this statement on behalf of myself as a representative of the bidder/offeree, and on behalf of the bidder/offeree's officers, representatives, agents, subcontractors, and employees.

I hereby declare under penalty of perjury under the laws of Guam that the foregoing is true and correct.

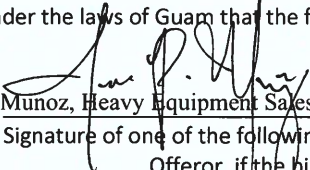
  
Jesse Munoz, Heavy Equipment Sales Manager

Signature of one of the following:

- Offeror, if the bidder/offeree is an individual;
- Partner, if the bidder/offeree is a partnership;
- Officer, if the bidder/offeree is a corporation.

ORIGINAL

**DECLARATION DISCLOSING OWNERSHIP, INFLUENCE, COMMISSIONS  
AND CONFLICTS OF INTEREST**

(Required by 5 GCA § 5233 as amended by P.L. 36-13 (4/9/2021))

Preface. As a condition of submitting a Bid/Offer/Proposal or responding to any method of source selection under Guam's Procurement Law for the purpose of entering into a contract with the government of Guam, this Affidavit requires all Bidders/Offerors/Prospective Contractors to make disclosures of ownership, influence, commissions, gratuities, kickbacks, and conflicts of interest occurring **during the 365 calendar days preceding the publication of this solicitation and until award of a contract**. This includes the duty to disclose **any changes** to the facts disclosed herein throughout the solicitation process; and if the entity submitting this Affidavit is awarded a contract, the duty to disclose **any changes** to the facts disclosed herein **continues throughout the life of the contract, including any extensions or renewals**.

A. I, the undersigned, hereby declare that I am an authorized representative of the Bidder/Offeror/Prospective Contractor and that (please check and fill out all that apply):

The Bidder/Offeror/Prospective Contractor is an individual with a business license, and all decisions are by, and all profit is for, that same individual, with principal place of business street address being:

\_\_\_\_\_

\_\_\_\_\_

The Bidder/Offeror/Prospective Contractor is a business or artificial person (as defined in 1 GCA § 715 or 5 GCA §§ 5030(n) or 5233(b)), and is a sole proprietorship owned entirely (100%) by \_\_\_\_\_, with principal place of business street address being:

\_\_\_\_\_

\_\_\_\_\_

The Bidder/Offeror/Prospective Contractor is a business or artificial person (as defined in 1 GCA § 715 or 5 GCA §§ 5030(n) or 5233(b)), and is owned by the following multiple individuals. Note: owners of more than 10% are statutorily required to be listed below, but other owners of smaller percentage are encouraged to be listed as well.

Name of Owner	Principal Place of Business Street Address	% of Interest
_____	_____	_____
_____	_____	_____
_____	_____	_____

One or more of the more-than-10% owners listed above is a business or artificial person. Any more-than-25% owners of such a business or artificial person are listed below per 5 GCA § 5233. Note: any less-than-25% owners of such a business or artificial person is encouraged to also be listed below.

**Name of >10% Owner Business or Artificial Person:**

\_\_\_\_\_

Names of owners of the >10% Owner Business or Artificial Person ("Second Tier Owner")	Owner's Principal Place of Business Street Address	% of Interest

**ORIGINAL**

Morrigo Equipment Holding Inc	197 Ypao Road, Tamuning, Guam 96913	100%

Name of other >10% Owner Business or Artificial Person:

--

Names of owners of the >10% Owner Business or Artificial Person ("Second Tier Owner")	Owner's Principal Place of Business Street Address	% of Interest

B. If any Second Tier Owner identified above is an artificial person, the natural or artificial owners of such Second Tier Owner who have held more than 49% of the shares or interest in the Bidder/Offeror/Prospective Contractor (Third Tier Owners) are as follows [if none, please so state]:

Second Tier Owner Name \_\_\_\_\_

Name of Third Tier Owner	Principal Place of Business Street Address	% of Interest
_____	_____	_____
_____	_____	_____
_____	_____	_____

C. If the name of no natural person has been identified as an owner, or a Second or Third Tier Owner of the Bidder/Offeror/Prospective Contractor, please identify the name, position, address, and contact information of the natural person having the authority and responsibility for the Bid/Offer/Proposal/Prospective Contract, and the name of any natural person who has the authority and power to remove and replace the designated responsible person:

Name of Natural Person	Position	Street Address of Principal Place of Business	Phone Number, Email Address, and other Contact Information
Jesse Munoz	Heavy Equipment Sales Manager	197 Ypao Road Tamuning, GU 96913	jesse.munoz@morrigoequipment.com

D. Further, I say that the persons who have received or are entitled to receive a commission, gratuity, contingent fee or other compensation to solicit, secure, or assist in obtaining business related to the Bid/Offer/Proposal/Prospective Contract for which this Affidavit is submitted are as follows (if none, please so state):

Name	Principal Place of Business Street Address	Amount of Compensation
_____	_____	_____
_____	_____	_____

E. Further, I say that the persons who have directly or indirectly participated in this solicitation and who are also employees of the government of Guam or the government of the United States, if federal funds are to be used

ORIGINAL

in the payment of the contract related to the Bid/Offer/Proposal/Prospective Contract for which this Affidavit is submitted, are as follows (if none, please so state):

Name	Principal Place of Business Street Address
_____	_____
_____	_____

F. Regardless of any ownership interest, the following individuals have the power to control the performance of the contract or to control the Bidder/Offeror/Prospective Contractor, directly or indirectly:

Name	Principal Place of Business Street Address
_____	_____
_____	_____

G. Until award of the contract, and throughout the term of any contract awarded to the Bidder/Offeror/Prospective Contractor represented herein, I agree to promptly make any disclosures not made previously and update changes in ownership, identities of owners and other required information, interests, compensation or conflicts of the persons required to be disclosed. I understand that failure to comply with this requirement shall constitute a material breach of contract.

H. I hereby declare under penalty of perjury under the laws of Guam that the foregoing is true and correct.

Executed on: Feb 15, 2024 (date)

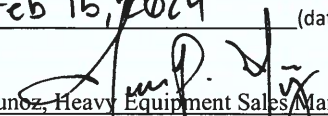
  
\_\_\_\_\_  
Jesse Munoz, Heavy Equipment Sales Manager

Signature of one of the following:  
Bidder/Offeror/Prospective Contractor, if a licensed individual  
Owner of sole proprietorship Bidder/Offeror/Prospective Contractor  
Partner, if the Bidder/Offeror/Prospective Contractor is a partnership  
Officer, if the Bidder/Offeror/Prospective Contractor is a corporation



**DECLARATION RE: CONTINGENT FEES  
(AG Form 007)**

Jesse Munoz [state name of declarant signing below], hereby declares that:

1. The name of the bidding/offering company or individual is [state name of company]

Morrice Equipment LLC

2. As a part of the bidding/offering company's bid or proposal, to the best of my knowledge, the offering company has not retained any person or agency on a percentage, commission, or other contingent arrangement to secure this contract. This statement is made pursuant to 2 GAR Division 4 § 11108(f).

3. As a part of the bidding/offering company's bid or proposal, to the best of my knowledge, the bidding/offering company has not retained a person to solicit or secure a contract with the government of Guam upon an agreement or understanding for a commission, percentage, brokerage, or contingent fee, except for retention of bona fide employees or bona fide established commercial selling agencies for the purpose of securing business. This statement is made pursuant to 2 GAR Division 4 § 11108(f).

4. I make these statements on behalf of myself as a representative of the bidder/offeror, and on behalf of the Bidder/Offerors officers, representatives, agents, subcontractors, and employees.

I hereby declare under penalty of perjury under the laws of Guam that the foregoing is true and correct.

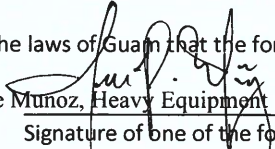
  
Jesse Munoz, Heavy Equipment Sales Manager

Signature of one of the following:

Bidder/Offeror, if the bidder/offeror is an individual; Partner, if the bidder/offeror is a partnership; Officer, if the bidder/offeror is a corporation.

## CONFLICT OF INTEREST GUIDELINES

Offerors shall follow these Conflict of Interest (COI) Guidelines when submitting any Proposal in response to a federally funded Port Authority of Guam solicitation or procurement or when entering into any federally funded Contract with Port Authority of Guam. The Contractor shall follow these COI Guidelines throughout the period during which the Proposal/Bid is open or the Contract is in effect. An Offeror shall provide the COI Guidelines and associated COI Disclosure Form to all of its Subconsultants and Subcontractors at any tier of a Proposal or Contract and shall ensure that the Offeror and each of its Subconsultants or Subcontractors make any disclosures required by these guidelines or as required by a specific Procurement or Contract. The Port Authority of Guam will follow and apply these COI Guidelines when conducting Port Authority of Guam procurements.

### 1. Definitions.

The definitions that apply to these COI Guidelines and the Port Authority of Guam's COI Disclosure Form are at the end of this document.

### 2. Required Disclosures.

**Submittal of a Correct and signed COI Disclosure Form is required if any of the following apply (note that for the purposes of these COI Guidelines "Public Employee" includes all Port Authority of Guam employees):**

- an Offeror or any of its Associates have any Apparent, Potential, or Actual Conflicts of Interest per these COI guidelines or per the criteria of any COI Form included as part of a Procurement or Contract;
- a Procurement or Contract document specifically requires submittal of a COI Disclosure Form (e.g., if the prospective Project includes preparation of an Environmental Impact Statement or Environmental Assessment, submittal of COI Disclosure Forms is always required.);
- an Offeror has any changes to its staffing or organization (whether before or after entering into a Contract) that result in an Apparent, Potential or Actual Conflict of Interest per these guidelines or per the criteria of any COI form associated with a particular Procurement or Contract. Any such changes shall be disclosed within 10 business days via submittal of a complete and signed COI Disclosure Form.
- the response to any of the following questions is "yes" (with respect to a Procurement or current Contract with Port Authority of Guam):
  1. Is any Associate of the Offeror a former employee of Port Authority of Guam (within the last year)? No
  2. Is any Associate of the Offeror a Relative, Immediate Family Member, or Member of the Household of a current employee of Port Authority of Guam who had or may have a role in this Procurement, Authorization of the Contract, Contract administration, or oversight of the Contractor's performance?
  3. Does the Offeror or any Associate of the Offeror have an Actual, Apparent or Potential Conflict of Interest ("Individual" or "Organizational") with regard to any member of an Port Authority of Guam Procurement evaluation or selection team?
  4. Did the Offeror or any Associate of the Offeror conduct prior work on the Project described in the Procurement, or participate in preparing any part of the Procurement or any documents or reports related to the Procurement or to which the Procurement refers?
  5. Does the Offeror or any Associate of the Offeror have any past, present or currently planned interests which are an Actual, Apparent, or Potential Conflict of Interest ("Individual" or "Organizational") with respect to performing the work for Port Authority of Guam?
  6. Has the Offeror or an Associate of the Offeror offered to a Public Employee, or is the Offeror aware of any Public Employee that has solicited or received, directly or indirectly, any pledge or promise of employment or other benefit based on the understanding that the Public Employee's vote, official action or judgment would be influenced thereby?
  7. Has (or will) the Offeror or an Associate of the Offeror provided a direct beneficial financial interest to any person within one year after the person ceased to hold a position as a Public Employee who was involved in the Procurement or Authorization for the Contract, or is the Offeror aware of any such person or Public Employee who has or will receive a direct beneficial financial interest within the one-year period?
  8. Is the Offeror aware of any current or former Public Employee that has an Actual, Apparent, or Potential Conflict of Interest with respect to the Procurement or award of this Contract or performing the work for Port Authority of Guam?
  9. Does the prospective Contract include development of an environmental assessment (EA) or environmental impact statement (EIS)?
  10. If a Procurement is to obtain personal services for the purpose of administering, managing, monitoring, inspecting, evaluating compliance with or otherwise overseeing a public contract, is the Offeror or an Associate or an Affiliate of the Offeror a party to the subject public contract?
  11. Has the Offeror or any Associate of the Offeror entered into any contract(s) with Port Authority of Guam for the purpose of advising or assisting in developing any part of the solicitation documents, including specifications,

ORIGINAL

requirements, a scope or statement of work, an invitation to bid, a request for proposals or other documents and materials used in, or related to this procurement?

If none of the foregoing apply, an Offeror shall provide a written and signed certification (specified by Port Authority of Guam) that the Offeror has read and complied with these COI Guidelines and the COI Disclosure Form and did not answer Yes to any of the questions, or, if required by the Port Authority of Guam, the Offeror shall complete and submit a Correct and signed COI Disclosure Form.

An Offeror shall incorporate in each required COI Disclosure Form any COI disclosure information provided by its staff and attach COI Disclosure Forms from each of its Subcontractors (that have required disclosures of conflicts or potential conflicts of interest), prior to such Offeror performing any services under a Contract.

The COI Disclosure Form is attached to the solicitation as a mandatory form that must be signed and submitted with Offeror's Proposal.

### **3. Governing Standards.**

Both Guam and federal laws govern disclosure and management of conflicts of interest in contracting processes. The disclosure requirements of these COI Guidelines apply to all Port Authority of Guam contracting activities (Architectural and Engineering (A&E) and non-A&E, public improvements, goods, and trade services) without regard to which particular federal or Guam laws govern the activity. There are also Standards of Conduct Policies for conflicts of interest regarding current Port Authority of Guam employees, and the employment of former Port Authority of Guam employees, which are applicable to this procurement, and are explained below.

#### **Standards of Conduct Policy Regarding Former Port Authority of Guam Employees**

When employees of firms which compete for or have Contracts with the Port Authority of Guam come to work for the Port Authority of Guam, and when Port Authority of Guam employees go to work for firms which compete for or have Contracts with the Port Authority of Guam, a Potential Conflict of Interest may exist.

Use of a former Port Authority of Guam employee by an Offeror on the same, or substantially similar Procurement, for which the employee performed a role or function for the Port Authority of Guam, unless mitigated to the satisfaction of the Port Authority of Guam, is prohibited for a period of one year following separation of employment with the Port Authority of Guam. Roles and functions of particular concern include drafting specifications or statements of work, reviewing or scoring a bid or proposal, authorizing service or assigning work, awarding a Contract, administering a Contract, or overseeing Contractor's performance. The Port Authority of Guam may determine that the role or Procurement is not substantially similar because of differences in location of the Project or work, because of the type and method of Procurement, because the employee did not participate personally or substantially in the procurement, because the role performed was minor in nature, such as a technical sufficiency review, or because the Civil Service Commission has granted the employee an applicable waiver. Examples of mitigation that may, in appropriate situations, be acceptable to the Port Authority of Guam include separation of certain decision-making functions concerning the Project, not using the employee in preparation of proposals but allowing them to perform work on the Project, and not having the employee have direct contact with Port Authority of Guam staff formerly under his/her supervision.

For each Procurement, Offerors shall disclose to Port Authority of Guam the identification of any of Offeror's employee(s) that had been employed by Port Authority of Guam within the twelve-month period prior to the submission date for the Proposal or bid. Each Offeror's disclosure shall include a signed statement by the former Port Authority of Guam employee of their proposed role for the Offeror in the particular Procurement and any resulting Contract. Failure of an Offeror to disclose such relationship or to remedy such potential violation will result in the rejection of the Offeror's bid or cancellation of the Contract with the Port Authority of Guam as well as being grounds for cancellation of an Offeror's prequalification or designation of an Offeror as ineligible for future Procurements as not being a responsible bidder. (Also see below regarding the ban on any direct beneficial or financial interest.)

#### **Standards of Conduct Regarding Current Port Authority of Guam Employees Conflicts of Interest**

The Guam Procurement Law statutory and regulatory framework, as generally applied, addresses conflicts of interest in public contracting by emphasizing the need for open and impartial Procurement methods and by prohibiting certain conflicts of interest involving public officials. The following statutes and administrative rules establish Guam's general policies and the restrictions and prohibitions regarding conflicts of interest for public contracts and Public Employees:

- The policies of the Guam Procurement Law (5 GCA § 5001, et seq) encourage public contracting competition that supports openness and impartiality to the maximum extent possible, while recognizing that the nature of effective and meaningful competition depends upon the service being procured.
- According to 5 GCA §§ 5001(b), 5003, and 5625, a sound and responsive public contracting system should instill public confidence through ethical and fair dealing, honesty, and good faith on the part of government officials and those who do business with the government.
- Article 11 of the Guam Procurement Law, Ethics in Public Contracting, and Article 2 of the Standards of Conduct for Elected Officers, Appointed Officers and Public Employees of the Government of Guam prohibit conflicts of interest of Public Employees and prohibit Public Employees from obtaining outside financial benefits for the exercise of their official duties. Among the prohibitions are offering a public employee a fee, a pledge of future employment, or anything valued in excess of \$200 based on an understanding that the offer would influence the public employee's official action or judgment.
- 5 GCA § 5632(a) provides the following: "Contemporaneous Employment Prohibited. Except as may be permitted by regulations pursuant to this Chapter or pursuant to Title 4 GCA, or rulings of the Civil Service Commission pursuant to this Chapter, it shall be a breach of ethical standards for any employee who is participating directly or indirectly in the procurement

ORIGINAL

process to become or be, while such an employee, the employee of any person contracting with the governmental body by whom the employee is employed. Notice of this provision shall be provided in accordance with regulations promulgated by the Civil Service Commission."

- 5 GCA § 5632(c) and (d) provide the following: "(c) Disqualification of Business When an Employee Has a Financial Interest. It shall be a breach of ethical standards for a business in which an employee has a financial interest knowingly to act as a principal, or as an agent for anyone other than the Territory, in connection with any:

- (1) judicial or other proceeding, application, request for a ruling or other determination;
- (2) contract;
- (3) claim; or

(4) charge or controversy; in which the employee either participates personally and substantially through decision, approval, disapproval, recommendation, the rendering of advice, investigation or otherwise, or which is the subject of the employee's official responsibility, where the Territory is a party or has a direct and substantial interest.

(d) Selling to the Territory After Termination of Employment is Prohibited. It shall be a breach of ethical standards for any former employee, unless the former employee's last annual salary did not exceed Twelve Thousand Dollars (\$12,000.00), to engage in selling or attempting to sell supplies, services other than personal services, or construction to the Territory for ninety (90) days following the date employment ceased.

The term sell as used herein means signing a bid, proposal, or contract; negotiating a contract, contracting any employee for the purpose of obtaining, negotiating or discussing changes in specifications, price, cost allowances or other terms of a contract; settling disputes concerning performance of a contract; or any other liaison activity with a view toward the ultimate consummation of a sale although the actual contract therefor is subsequently negotiated by another person; provided, however, that this Section is not intended to preclude a former employee from accepting employment with private industry solely because the former employee's employer is a contractor with this Territory, nor shall a former employee be precluded from serving as a consultant to this Territory."

- 4 GCA § 15201 states: "No employee shall solicit, accept, or receive, directly or indirectly, any gift valued singly or in the aggregate from a single source in excess of \$200, whether in the form of money, prize, service, loan, travel, entertainment, hospitality, thing or promise, or in any other form, when a reasonable person would infer that the gift is intended to influence the employee in the performance of that individual's official duties or is intended as a reward for any official action on that individual's part."

- 4 GCA § 15204 (a), (b), (c), and (d) provide: "No employee shall use or attempt to use an official position to secure or grant unwarranted privileges, exemptions, advantages, contracts, or treatment, for himself or herself, a spouse, children, or others, including but not limited to the following:

- (a) seeking other employment or contract for services by the use or attempted use of the individual's office or position;
- (b) accepting, receiving, or soliciting compensation for the performance of official duties or responsibilities except as provided by law;
- (c) using government time, equipment, or other facilities for private business purposes;
- (d) soliciting, selling, or otherwise engaging in a financial transaction with a subordinate or a person or business whom the employee inspects or supervises in official capacity."

- 4 GCA § 15205 (a), (b), (c), (d), and (e) provide: "Conflicts of Interest.

(a) No employee shall take any official action directly affecting:

- (1) business or other undertaking in which the employee has a financial interest; or
- (2) private undertaking in which the employee is engaged as legal counsel, advisor, consultant, representative, or other agency capacity. A department head who is unable to be disqualified on any matter described in item (1) or (2) of this Subsection may be in violation of this Subsection even if the individual has complied with the disclosure requirements of § 15208; and a person whose position on a board, commission or committee is mandated by statute, resolution or executive order to have particular qualifications shall only be prohibited from taking official action that directly and specifically affects a business or undertaking in which such person has a financial interest; provided that the financial interest is related to the member's particular qualifications.

(b) No employee shall acquire financial interests in any business or other undertaking which the employee has reason to believe may be directly involved in official action to be taken by the employee.

(c) No employee shall assist any person or business or act in a representative capacity before any territorial agency for any compensation in any transaction involving the Territory.

(d) No employee shall assist any person or business or act in a representative capacity for a fee or other compensation to secure passage of a bill or to obtain a contract, claim, or other transaction or proposal in which the employee has participated or will participate as an employee, nor shall the employee assist any person, or business, or act in a representative capacity for a fee or other compensation on such bill, contract, claim, or other transaction or proposal before the Legislature or territorial agency of which the individual is an employee.

(e) No employee shall assist any person or business or act in a representative capacity before a territorial agency for a fee or other compensation, on any bill, contract, claim, or other transaction or proposal involving official action by the agency if the employee has official authority over that agency unless such employee has complied with the disclosure requirements of § 15208."

- 4 GCA § 15206 states: “Contracts.

(a) A territorial agency shall not enter into any contract with an employee or with a business in which an employee has a controlling interest, unless the contract has been awarded through an open, public process. A territorial agency may, however, enter into such contract without resort to competitive bidding process when, in the opinion of the General Services Agency or the procurement officer of that branch of government, the property or services does not fall within the purview of competitive bidding; provided that written justification for the non-competitive award of such contract be made a matter of public record and shall be filed with the Guam Ethics Commission at least ten (10) days before such contract is entered into. With regards to members of boards, commissions, and committees, this Subsection shall apply only to contracts entered into between a business in which a member has a controlling interest and a territorial agency in which the board, commission, or committee to which the individual is appointed has jurisdiction.

(b) A territorial agency shall not enter into a contract with any person or business which is represented or assisted in a material manner in the matter by a person who has been an employee of that agency within the preceding twelve (12) months and who participated while in 8 territorial office or employment in a material manner in the matter with which the contract is directly concerned.”

Port Authority of Guam’s COI Guidelines embody the intent of encouraging competition through openness, impartiality, and public disclosure of relevant information (and the avoidance of conflicts of interest) as described in Guam’s Procurement Law, Title 5, Chapter 5, Article 11, Ethics in Public Contracting; Title 4, Chapter 15, Standards of Conduct for Elected Officials, Appointed Officers, and Public Employees of the Government of Guam, The Guam Department of Administration Personnel Code of Conduct and Port Authority of Guam’s Standards of Conduct Policies or any other applicable governmental ethics policies.

The one-year prohibition against a Public Employee having a direct beneficial financial interest in a public contract as provided in 5 GCA § 5632(b) would generally preclude the person from working under the public contract and from representing the Offeror in dealings with the public agency for whom the person had worked. Sharing in the general profits of the Offeror (such as a year-end bonus for overall corporate profits) is likely not a direct beneficial financial interest, however, a bonus or other compensation paid just on the basis of the public contract would be subject to the prohibition.

**Standards of Conduct for Offerors and Contractors, and Organizational Conflicts of Interest Policy**

It is the policy of Port Authority of Guam to avoid, neutralize, or mitigate organizational conflicts of interest that might exist for all procurements. Each individual contracting situation shall be examined on the basis of its particular facts and the nature of the proposed contract. The exercise of common sense, good judgment, and sound discretion is required in both the decision on whether a significant potential conflict exists and, if it does, the development of an appropriate means for resolving it. The principles underlying this policy are: (1) preventing the existence of conflicting roles that might bias an Offeror’s judgment; and (2) Preventing unfair competitive advantage. In addition to the other situations described in these COI Guidelines, an unfair competitive advantage exists where an Offeror competing for award of any Port Authority of Guam contract possesses: (1) proprietary information that was obtained from a Public Employee without proper authorization; or (2) source selection information that is relevant to the contract but is not available to all competitors, and such information would assist that Offeror in obtaining the contract.

The following situations constitute organizational conflicts of interest. This listing is not exhaustive:

- A conflict of interest exists when an Offeror that provides systems engineering and technical direction for a system is awarded a contract to supply the system or any of its major components; or is a subcontractor or consultant to a supplier of the system or any of its major components; even if the Offeror did not have overall contractual responsibility for the system’s development, its integration, assembly, and checkout, or its production. In this example, systems engineering includes a combination of substantially all of the following activities: determining specifications, identifying and resolving interface problems, developing test requirements, evaluating test data, and supervising design. Technical direction includes a combination of substantially all of the following activities: developing work statements, determining parameters, directing other contractors’ operations, and resolving technical controversies. In performing these activities, a contractor occupies a highly influential and responsible position in determining a system’s basic concepts and supervising their execution by other contractors. Therefore, this Offeror should not be in a position to make decisions favoring its own products or capabilities.
- A conflict of interest exists when an Offeror prepares and furnishes complete specifications covering non-developmental items, to be used in a competitive procurement, and submits a proposal or bid to be allowed to furnish these items, either as a prime contractor or as a subcontractor, for a reasonable period of time including, at least, the duration of the initial production contract.
- If a single contractor drafts complete specifications for non-developmental equipment, that contractor should be eliminated for a reasonable time from competition for production based on the specifications. This should be done in order to avoid a situation in which the contractor could draft specifications favoring its own products or capabilities. In this way the Government can be assured of getting unbiased advice as to the content of the specifications and can avoid allegations of favoritism in the award of production contracts.
- When an Offeror prepares, or assists in preparing, a statement of work, scope of services, or technical specifications to be used in competitively acquiring a system or services, or provides material leading directly, predictably, and without delay to such a statement of work, scope of services, or technical specifications, it is a conflict of interest if that Offeror submits a Proposal or bid to supply the system, major components of the system, or the services, unless:
  - (i) It is the sole source;
  - (ii) It has participated in the development and design work; or

(iii) More than one contractor has been involved in preparing the statement of work, scope of services, or technical specifications.

- Agencies should normally prepare their own statements of work, and scopes of services. When contractor assistance is necessary to prepare the statement of work or scope of services, the contractor is in a position to favor its own products or capabilities. To overcome the possibility of bias, Offerors are prohibited from supplying a system or services acquired on the basis of a statement of work or scope of services growing out of their services, unless:
  - (i) It is the sole source;
  - (ii) It has participated in the development and design work; or
  - (iii) More than one contractor has been involved in preparing the statement of work, scope of services, or technical specifications.
- It is a conflict of interest for a contractor to participate in the evaluation of products or services that it offers. Contracts for the evaluation of offers for products or services shall not be awarded to an Offeror that will evaluate its own offers for products or services, or those of a competitor.

The following situations are not considered to constitute organizational conflicts of interest. This list is not exhaustive:

- In development work, it is normal to select firms that have done the most advanced work in the field. These firms can be expected to design and develop around their own prior knowledge. Development contractors can frequently start production earlier and more knowledgeably than firms that did not participate in the development, and this can affect the time and quality of production, both of which are important to the Government. In many instances the Government may have financed the development. Thus, while the development contractor has a competitive advantage, it is an unavoidable one that is not considered unfair; hence this is not considered an organizational conflict of interest.
- It is not an organizational conflict of interest for Offerors that furnish, at Government request, specifications or data regarding a product they provide, even though the specifications or data may have been paid for separately or in the price of the product.
- It is not an organizational conflict of interest where Offerors, acting as industry representatives, help Government agencies prepare, refine, or coordinate specifications, regardless of source, provided this assistance is supervised and controlled by Government representatives.

It is further the policy of Port Authority of Guam to restrict Offeror's use of confidential or proprietary information obtained from previous affiliations with the Port Authority of Guam or the Government when competing for Port Authority of Guam contracts. When a contractor requires proprietary information to perform a Government contract and can use the leverage of the contract to obtain it, the contractor may gain an unfair competitive advantage unless restrictions are imposed. These restrictions protect the information and encourage companies to provide it when necessary for contract performance. They are not intended to protect information: (1) furnished voluntarily without limitations on its use; or (2) available to the Government or contractor from other sources without restriction.

In addition, a contractor that gains access to proprietary information of other companies in performing advisory and assistance services for the Government must agree with the other companies to protect their information from unauthorized use or disclosure for as long as it remains proprietary and refrain from using the information for any purpose other than that for which it was furnished. The Offeror shall provide Port Authority of Guam with copies of these agreements and ensure that they are properly executed.

Contractors also obtain proprietary and source selection information by acquiring the services of marketing consultants which, if used in connection with an acquisition, may give the contractor an unfair competitive advantage. Contractors should make inquiries of marketing consultants to ensure that the marketing consultant has provided no unfair competitive advantage, and must disclose these relationships to Port Authority of Guam on the COI Disclosure Form.

#### **Specific Federal Standards—Procurements Related to Design-Build and Design-Bid-Build**

Pursuant to 23 USC § 112(b)(3), the FHWA has promulgated administrative rules that affect federally funded Design-Build procurements and related procurements. These rules, which are in Chapter 23 of the CFR Part 636, are used as the basis for Port Authority of Guam's guidelines on the subject and specifically regulate both Organizational and Individual Conflicts of Interest. Port Authority of Guam's COI Guidelines incorporate a number of concepts from these federal provisions.

The primary rule governing Organizational Conflicts of Interest in Design-Build transactions is 23 CFR § 636.116. This rule affects not only Design-Build procurements, but also "any contract for engineering services, inspection or technical support in the administration of the Design-Build contract." Following is a summary of this federal rule (Port Authority of Guam's COI Guidelines apply this rule to design-bid-build and non-A&E activities as well):

Generally, a consultant who assists the state in preparing a Request for Proposals (RFP) document may not, subsequently, propose in response to the RFP. However, the state may determine that the consultant does not have a conflict of interest for a subsequent Procurement, if the consultant furnished only "low-level" documents that were incorporated into the RFP and made available to all offerors, and did not assist the state in the development of instructions to offerors or evaluation criteria for the RFP. These Design-Build regulations also apply to "improper business practices and personal conflicts of interest" of the Port Authority of Guam's selection team members. 23 CFR § 636.117 indicates that Federal Acquisition Regulations ("FARs"--- specifically 48 CFR Part 3, Improper Business Practices and Personal Conflicts of Interest) will apply to the state's selection team members in the absence of relevant state laws and procedures. These regulations require government business to be "above

reproach," conducted "with complete impartiality and with preferential treatment for none" and with "the highest degree of public trust and an impeccable standard of conduct" to avoid "even the appearance of a conflict of interest." In design-bid-build transactions, where engineering services are procured separately from the construction services, ordinarily the consulting Offeror providing the engineering services is not eligible to bid on the construction work for the Project.

No Offeror or any Associate of an Offeror in connection with a Transportation Project shall have, directly or indirectly, any interest, other than his employment or retention by a State or other governmental instrumentality, in any Contract in connection with such Project. No firm or an Associate of an Offeror shall have, directly or indirectly, any interest in any real property acquired or to be acquired for a Project unless such interest is openly disclosed upon the records of Port Authority of Guam and such Offeror or Associate has not participated and will not participate in such acquisition for and in behalf of Port Authority of Guam (see 23 CFR § 1.133).

#### **Specific Federal Standards - National Environmental Policy Act (NEPA)**

No Offeror preparing or providing environmental analysis or impact documents relating to a Project, including draft and final Environmental Assessments (EA) or Environmental Impact Statements (EIS) may have a financial or other interest in the outcome of the Project. A financial or other interest in the outcome of the Project includes any known benefits other than general enhancement of professional reputation, and includes any agreement, enforceable promise, guarantee or expectation of future work on the Project as well as any indirect benefit the Offeror is aware of such as if the Project would aid proposals sponsored by the Offeror's other clients. Compliance with 40 C.F.R. 1506.5(c) is required, which includes the requirement for a conflict of interest disclosure statement from each Offeror establishing that the Offeror does not have a financial or other interest in the Project.

#### **4. COI Considerations Related to Previous Work on Projects.**

No Offeror that has previously performed services on behalf of Port Authority of Guam for a Project may be a Proposer or participate as an equity owner, team member, Subcontractor of or to a Proposer on the Project, or have a financial interest in any of the foregoing entities with respect to the Project, unless Port Authority of Guam is satisfied in its sole discretion that:

- (a) such services were completed prior to initiation of the Procurement for the Project (exceptions may apply for NEPA services on a case-by-case evaluation of the project specifics against the applicable CFRs);
- (b) such services included only Low-Level Documents and did not include development of instructions to offerors or evaluation criteria for the RFP;
- (c) such services did not provide the Offeror with access to or knowledge of Port Authority of Guam confidential or inside information that could provide an unfair competitive advantage with respect to the Procurement;
- (d) the prior Contract and information provided to the Offeror in the performance of its services are either irrelevant to the Procurement or are available on an equal and timely basis to all Proposers;
- (e) the work product from the Offeror incorporated into or relevant to the Procurement is available through Public Disclosure on an equal and timely basis to all Proposers; and
- (f) any environmental documents prepared by the Offeror have been determined to be objective, and that the Port Authority of Guam demonstrated independent decision-making authority during the environmental process.

In such instances where Port Authority of Guam is satisfied in the manner described above, Port Authority of Guam may still, in its sole discretion, restrict the scope of Procurement services for which the Offeror shall be eligible to perform in order to further the intent and goals of these COI Guidelines.

Public Disclosure of services or products is an important consideration in determining if an Organizational Conflict of Interest exists. All COI Disclosure Forms will be considered public records, as permitted under Guam's Procurement Law.

#### **5. COI Disclosure Process.**

An Offeror shall certify its compliance with these COI Guidelines at the time of submitting a Proposal to Port Authority of Guam, during the Procurement Process, and during the time of performance of any awarded Contract with Port Authority of Guam. If submittal of COI Disclosure Form(s) is required per these COI Guidelines or a specific Procurement or Contract, an Offeror shall represent the correctness of a completed COI Disclosure Form. If an Offeror has any changes to its staffing or organization (whether before or after entering a Contract) that result in an Actual, Apparent or Potential Conflict of Interest (Individual or Organizational) per these COI Guidelines or per the criteria of any COI form associated with a particular Procurement or Contract, any such changes shall be disclosed within ten (10) business days via submittal of a Correct and signed COI Disclosure Form.

An Offeror shall assure that any COI Disclosure Form it submits includes any information required to be disclosed by its Subcontractors and other Associates, on behalf of the Offeror. An Offeror may submit either the Subcontractors' separate COI Disclosure Forms or incorporate Subcontractor information into its own COI Disclosure Form. The disclosure required with the proposal applies the prime and all proposed Subcontractors that are identified or anticipated at the time of proposal submission.

The identification, assessment, and management of Actual or Potential Conflicts of Interest are joint tasks among Port Authority of Guam, the Offeror and the Offeror's team. An Offeror must work together with Port Authority of Guam in an atmosphere of candor and accountability during the period of negotiation or performance of the Contract with Port Authority of Guam. Port Authority of Guam makes the final determination as to the adequacy of any COI disclosures or COI management plan offered by the Offeror.

Port Authority of Guam's COI determination is based on a number of factors such as:

- ✓ Situational Facts – description of the situation and all known facts specific to the actual or perceived COI
- ✓ Type of Work - specific product or service and Contract(s) involved
- ✓ Relationship to Management - specific interactions with Port Authority of Guam decision-makers
- ✓ Public Disclosure - timing and availability of product or service

The specific facts disclosed in any COI situation will be unique to that situation. Therefore, the decisions and conclusions reached in one situation may or may not be directly applicable to another. For example, the definition of “low-level” documents does not isolate an Offeror producing such documents from a potential COI situation. The ultimate determination will take into account the other factors described above.

#### **6. Examples of Conflict of Interest Situations.**

Port Authority of Guam offers the following examples to better illustrate conflict of interest situations that may arise during the course of the performance of a Personal Services Contract, Purchase Request, Purchase Order, or any Contract entered into between Port Authority of Guam and an Offeror, or during any Government of Guam Procurement process, in order to provide guidance to Offerors as they determine if their specific situations warrant disclosure, evaluation, and management.

1. A Design-Build solicitation requires the responding teams to propose how to manage site features that were uncovered by a geotechnical engineering Offeror. The Offeror’s reports to Port Authority of Guam on the Project are available to the public. A multi-specialty engineering Offeror that is the parent company of the geotechnical engineering Offeror submits a proposal to design the overall Project. Depending on the particular mitigating facts, Port Authority of Guam might determine in writing that the multi-specialty engineering Offeror is eligible to propose.
2. Port Authority of Guam seeks comprehensive project management services for a series of Transportation Projects. One of the proposing Offerors employed a senior official from Port Authority of Guam who played a significant role in providing direction for the solicitation, six months ago. Port Authority of Guam initially assesses this situation as a potential Organizational Conflict of Interest and provides information to potential Proposers of this assessment through an addendum to the RFP. In its proposal, the Proposer provides mitigating information and written assurances that this individual works in an area of the company that will not be working on their program management proposal and that the individual will be isolated inside the company from any information associated with the program, will not be lobbying Port Authority of Guam, will not engage in any activities that would violate the Port Authority of Guam Code of Conduct Policy for the prescribed one-year period, and for a period of one year will not have a direct beneficial interest in the contract. Depending on the particular facts, Port Authority of Guam might determine that, while the proposing Offeror has a potential Organizational Conflict of Interest, that conflict has been adequately mitigated and the Offeror will not be disqualified from submitting a proposal.
3. Port Authority of Guam issues an RFP for design and oversight of an intelligent system to collect bridge tolls. The RFP provides that companies having a financial interest in the relevant telecommunications hardware will be excluded from bidding. A company under common ownership with a major electronics manufacturer desires to bid. Port Authority of Guam initially assesses this situation as an Organizational Conflict of Interest, because it cannot know in advance whether the hardware products of this electronics manufacturer would be used in the Project, and Port Authority of Guam informs potential Proposers of its concern related to this type of conflict via addendum to the RFP. In its proposal, the company offers no mitigating facts or organizational plans that address Port Authority of Guam’s concerns about the conflict. Depending on the particular facts, Port Authority of Guam determines that the company has an actual conflict of interest.
4. Port Authority of Guam seeks advice of an industry advisory committee to formulate the specifications for an information technology (IT) RFP. An IT Offeror that participated in the advisory committee wishes to submit a proposal in response to the RFP. Depending on the particular facts, Port Authority of Guam might determine that the role of the Offeror was to represent the industry in the context of a public meeting where other Offerors were invited to submit comments, and that the Offeror therefore does not have an Organizational Conflict of Interest.
5. Port Authority of Guam contracts with an A&E Offeror to develop “low-level” documents prior to establishing a schedule for an RFP in which the “low level” documents, still under development, will be used by prospective Proposers. The A&E Offeror has attended the pre-proposal meeting and wishes to propose on the RFP. Port Authority of Guam determines that the company has a potential Organizational Conflict of Interest because of the fact that the low-level documents have not been made public and the Offeror will still be developing the documents during the solicitation. The company then mitigates the potential conflict of interest by suspending development of new reports during the open period of the solicitation and making all data and information sources available on an Port Authority of Guam website prior to the RFP release. Port Authority of Guam determines that the potential conflict has been adequately managed and the Offeror will not be disqualified from submitting a proposal or being part of the proposing team.
6. Port Authority of Guam contracts with a consulting Offeror to assist Port Authority of Guam in the development of an RFP and sample Contract for a Design-Build Procurement for construction of certain Transportation Projects. The Offeror has close contact with Port Authority of Guam decision-makers in the development of the evaluation criteria for the RFP and the proposed Contract terms, and that information is shared throughout the Offeror with all management and technical personnel. The Offeror will not be able to submit a proposal in the design-build Procurement, or participate as a team member with an Offeror submitting a proposal in response to the RFP.
7. Port Authority of Guam seeks comprehensive program management services for a series of Transportation Projects. Prior to release of the RFP, Port Authority of Guam shared its interpretation of the applicable conflict of interest requirements with the industry. One of the proposing Offerors has a related entity with a planned interest in future design-build construction work related to the transportation program. The COI Disclosure Form does not clearly state whether the related entity is a subsidiary, major partner, Subcontractor, or affiliate of a Subcontractor. The proposing



Offeror describes its intent to restrict the flow of information concerning construction Projects to the related entity and thereby to its affiliate construction company but does not clarify how much information will be shared between the principal and its Subcontractors and affiliates or the controls placed on the principal Subcontractor-affiliate relationship. Furthermore, the proposing Offeror has provided mitigation information, indicating that the related entity will not participate in providing services under the program management Contract (i.e., design, source selection, award of Contract, etc.). Port Authority of Guam may conclude the proposing Offeror does not have a conflict of interest that detracts from its eligibility for the program management award. Port Authority of Guam may determine that the related entity has a conflict of interest in future design-build construction work related to the bridge repair and replacement program that has not been adequately mitigated by the measures and information provided by the proposing Offeror. As a result, if the proposing Offeror is awarded the program management Contract, the related construction company will be ineligible for construction work under the program. This determination will depend upon the precise relationship between the related entity and the Proposer.

8. Completion of a project may encourage construction of a shopping center or industrial park from which an Offeror stands to benefit. If an Offeror is aware that it has such an interest in the decision on the proposal, it will be disqualified from preparing an EIS to preserve the objectivity and integrity of the NEPA process.
9. Port Authority of Guam issues an RFP for A&E services to prepare plans, specifications, and estimate (PS&E) to replace a bridge. The PS&E will be completed as part of a design-bid-build process. One of the A&E firms proposing on the design services owns XYZ Inc., a subsidiary that provides program management services to Port Authority of Guam under a separate contract. Port Authority of Guam's intent, as advertised in the RFP, is to use XYZ Inc. for administration and oversight of the A&E design services for the bridge replacement project. The A&E firm that is the parent of XYZ Inc. would be ineligible for award of the A&E design contract.
10. Port Authority of Guam issues an IFB for construction services to replace a bridge. The replacement is being done using the design-bid-build process. One of the construction firms bidding on the public improvement project owns XYZ Inc., a subsidiary that provides construction contract administration and inspection services to Port Authority of Guam under a separate contract. Port Authority of Guam's intent, as advertised in the IFB, is to use XYZ Inc. for administration and inspection of the bridge replacement project. The construction firm that is the parent of XYZ Inc. would be ineligible for award of the construction contract.

#### DEFINITIONS

The following definitions apply to these COI Guidelines and the Port Authority of Guam's COI Disclosure Form:

**"Actual Conflict of Interest"** means that an individual or Offeror is unable to render impartial assistance or advice to Port Authority of Guam, has impaired objectivity in performing the Project work, or has an unfair competitive advantage. "Actual Conflict of Interest" means any action or any decision or recommendation by a person acting in a capacity as a public official, the effect of which would be to the private pecuniary benefit or detriment of the person or the person's relative or any business with which the person or a relative of the person is associated unless the pecuniary benefit or detriment arises out of the circumstances described in the definition for "Potential Conflict of Interest" (see definition below).

**"Affiliate"** (of an Offeror) means a person or entity that, directly or indirectly through one or more intermediaries, controls, is controlled by, or is under common control of the Offeror.

**"Apparent Conflict of Interest"** means that an individual or Offeror may reasonably be perceived to have an Actual Conflict of Interest or a Potential Conflict of Interest.

**"Associate"** (of the Offeror) means an employee, executive, director, key project personnel, consultant, contractor, or Subcontractor, or any immediate family member of the foregoing.

**"Authorization"** (of the Contract). A public contract is authorized by a Public Employee if the Public Employee participated substantially in the procurement selection process or performed a significant role in the selection of an Offeror or the execution of the Contract. A significant role includes recommending approval or signing of the Contract, including serving as a reference, recommending selection or serving on a selection committee or team, or having the final authorizing authority for the Contract.

**"Bidder"** means a legally operating business entity submitting a bid in response to a Procurement solicitation.

**"Conflict of Interest" or "COI"** means an Individual Conflict of Interest or Organizational Conflict of Interest and includes an Actual, Potential, or Apparent Conflict of Interest.

**"COI Disclosure Form"** means a manually signed disclosure of any Actual Conflict of Interest, Apparent Conflict of Interest or Potential Conflict of Interest documented in the form of Port Authority of Guam's COI Disclosure Form.

**"COI Guidelines"** refers to this document and all references herein.

**"Contract"** means an Agreement, Contract, Purchase Request (PR), Work Order Contract (WOC), Purchase Order (PO), or any other type agreement with Port Authority of Guam, regardless of what it may be called, for the procurement or disposal of supplies, services, or construction.

**"Contractor"** means a legally operating business entity that has been awarded a contract in response to a Procurement.

**"Correct"** means, in the context of determining the accuracy of a COI Disclosure Form, that the form, in all material respects, is complete, accurate, not misleading, and does not omit any material information.

**"Immediate Family Member"** (of the Public Employee) means a spouse, children, parents, brothers and sisters, grandparents and grandchildren, mothers-in-law and fathers-in-law, brothers-in-law and sisters-in-law, daughters-in-law and sons-in-law. Stepsiblings, stepchildren and stepparents shall also be regarded as immediate family.

**"Individual Conflict of Interest"** means that an individual has a conflict of interest because of a financial interest, gift, or other activities or relationships with other persons including but not limited to individuals with whom the individual has business, familial or household relationships.

**"Interest"** (in the context of a conflict of interest) means a direct or indirect interest and includes a personal as well as financial interest.

**"Low-Level Document"** means A&E, non-A&E and IT program or Project-related documents which provide a basic understanding of a specific aspect of the program or Project. With regard to A&E and related services, it means that the role of the consultant or subconsultant was limited to provision of preliminary design, reports, or similar "low-level" documents that will be incorporated into the solicitation, and did not include assistance in development of instructions to offerors or evaluation criteria.

**"Member of the Household"** (of the Public Employee) means any person who resides with the Public Employee.

**"Offeror"** means a Proposer or Bidder under a Procurement solicitation, a consultant or contractor under a Contract, or a Subcontractor at any tier of a Proposer, consultant, or contractor, and any partner or member of any of the foregoing. An Offeror includes all persons, individual or corporate, without regard to form of legal entity, and any partner or member of any of the foregoing.

**"Organizational Conflict of Interest"** means that a relationship or situation exists whereby an Offeror or any of its Associates has past, present, or currently planned interests or activities that either directly or indirectly (through a client, contractual, financial, organizational or other relationship) may relate to the work to be performed under the proposed Contract with Port Authority of Guam and which: (a) diminish the Offeror's or an Associate's capacity to give impartial, technically sound, objective assistance or advice; (b) may impair the Offeror's or an Associate's objectivity in performing the Contract; (c) may impair Port Authority of Guam's objectivity in oversight of the Contractor's performance; or (d) may result in an unfair competitive advantage. It does not include the normal flow of benefits from the performance of the Contract.

**"Potential Conflict of Interest"** means that an individual or Offeror, as a result of current plans, may reasonably be expected to have an actual conflict of interest. "Potential Conflict of Interest" means any action or any decision or recommendation by a person acting in a capacity as a public official, the effect of which could be to the private pecuniary benefit or detriment of the person or the person's relative, or a business with which the person or the person's relative is associated, unless the pecuniary benefit or detriment arises out of the following: (a) an interest or membership in a particular business, industry, occupation or other class required by law as a prerequisite to the holding by the person of the office or position; (b) any action in the person's official capacity which would affect, to the same degree, a class consisting of all inhabitants of the state or a smaller class consisting of an industry, occupation or other group including one of which or in which the person, or the person's relative or business with which the person or the person's relative is associated, is a member or is engaged; or (c) membership in or membership on the board of directors of a nonprofit corporation that is tax-exempt under section 501(c) of the Internal Revenue Code.

**"Procurement"** means a Request for Proposals (RFP), Request for Quotes (RFQ), Request for Information (RFI), Invitation for Bid (IFB), or any other form of solicitation or Procurement by Port Authority of Guam.

**"Project"** means any proposed or existing undertaking pertaining to such programs that are assigned to Port Authority of Guam under applicable law.

**"Proposal"** means a bid, proposal, or other submission appropriate to a Procurement.

**"Proposer"** means a legally operating business entity submitting a Proposal in response to a Procurement.

**"Public Disclosure"** means the work product or service (in connection with the preparation of a Procurement) is available for public review and analysis for a reasonable amount of time, typically at least thirty (30) calendar days.

**"Public Employee"** means any person who is serving the government of Guam or any of its political subdivisions or any other governmental body as defined in 5 GCA § 5125 as an elected official, appointed official, employee, agent, or otherwise, irrespective of whether the person is compensated for the services. (For the purposes of these COI Guidelines, all Port Authority of Guam employees are considered Public Employees under this definition.)

**"Relative"** (of a Public Employee) means:

- any individual who is related to the public official as father, mother, son, daughter, brother, sister, uncle, aunt, first cousin, nephew, niece, husband, wife, father-in-law, mother-in-law, son-in-law, daughter-in-law, brother-in-law, sister-in-law, stepfather, stepmother, stepson, stepdaughter, stepbrother, stepsister, half brother, or half sister; or
- any individual for whom the Public Employee has a legal support obligation or for whom the Public Employee provides benefits arising from the Public Employee's public employment or from whom the Public Employee receives benefits arising from that individual's employment.

**"Subcontractor"** means a contractor or subcontractor at any tier lower than the awarded Contractor.

The non-Federal entity must maintain written standards of conduct covering conflicts of interest and governing the actions of its employees engaged in the selection, award and administration of contracts. No employee, officer, or agent may participate in the selection, award, or administration of a contract supported by a Federal award if he or she has a real or apparent conflict of interest. Such a conflict of interest would arise when the employee, officer, or agent, any member of his or her immediate family, his or her partner, or an organization which employs or is about to employ any of the parties indicated herein, has a financial or other interest in or a tangible personal benefit from a firm considered for a contract. The officers, employees, and agents of the non-Federal entity may neither solicit nor accept gratuities, favors, or anything of monetary value from contractors or parties to subcontracts. However, non-Federal entities may set standards for situations in which the financial interest is not substantial or the gift is an unsolicited item of nominal value. The standards of conduct must provide for disciplinary actions to be applied for violations of such standards by officers, employees, or agents of the non-Federal entity.

**CONFLICT OF INTEREST (COI) DISCLOSURE FORM**

**Government of Guam \*PORT AUTHORITY OF GUAM\* IFB No. PAG-004-24**

Offerors under Contract or proposing to enter into a Contract with \*PORT AUTHORITY OF GUAM\* must comply with the "Conflict of Interest Guidelines" attached to this solicitation. The definitions of terms used in this COI Disclosure Form shall be those provided in the Conflict of Interest Guidelines (note that "Public Employee" includes all \*PORT AUTHORITY OF GUAM\* employees).

This COI Disclosure Form is submitted in response to:

PAG-004-24

\*PORT AUTHORITY OF GUAM\*  RFP# \_\_\_\_\_ [or]  IFB# \_\_\_\_\_ (check only one)

Contract # \_\_\_\_\_ (if applicable)

Changes to COI Disclosure Form previously submitted for RFP # \_\_\_\_\_, IFB # \_\_\_\_\_, or Contract # \_\_\_\_\_ (if applicable)

This COI Disclosure Form must be signed in ink by an authorized representative of Offeror to certify that it is correct. An Offeror's certification that its disclosure form is correct includes the disclosure by its Associates and Subcontractors.

My signature certifies that as disclosed on or attached to the present form:

- (a) the Offeror's disclosures are complete, accurate, and not misleading.
- (b) the Offeror has provided the COI Guidelines to all Associates and Subcontractors (if any) and this form includes or has attached any required COI disclosures from those sources.

I hereby certify that I am authorized to sign this COI Disclosure Form as an Authorized Representative for the Offeror identified below:

**Complete Legal Name of Offeror:** Jesse Munoz

**Address:** 197 Ypao Road, Tamuning, Guam

**Telephone:** (671) 649-1946

**Fax No:** (671) 649-1947

**Signature:** \_\_\_\_\_



**Date:** Feb 15, 2024

Please answer all questions "Yes", "No" or "N/A" (if uncertain answer "Yes.") If the answer to any of the questions is "Yes," then use the applicable "Comments" fields to:

- (a) furnish all relevant facts that are necessary to make the response complete, accurate, and not misleading; and
- (b) identify any actions that must be taken to avoid, neutralize, or mitigate such conflict of interest (e.g. communications barriers, restraint or restriction upon future contracting activities, or other precaution)

Please add additional sheets as necessary to respond to the "Comments" field.

1. a) Is any Associate of the Offeror a former employee of \*PORT AUTHORITY OF GUAM\* within the last year? No  Yes   
 b) Is any Associate of the Offeror a Relative, Immediate Family Member, or Member of the Household of a current \*PORT AUTHORITY OF GUAM\* employee that had or will have any involvement with this Procurement or Contract Authorization? No  Yes

If the answer to either of the above questions is "Yes", complete the attached "Relatives and Former \*PORT AUTHORITY OF GUAM\* Employees - Roles and Signatures" table (Part A and/or Part B, as applicable).

2. Does the Offeror or any Associate of the Offeror have an Actual, Apparent or Potential Conflict of Interest ("Individual" or "Organizational") with regard to any known member of an \*PORT AUTHORITY OF GUAM\* Procurement evaluation or selection team? No  Yes  **Comments:**
3. Did the Offeror or any Associate of the Offeror conduct prior work on the Project described in the Procurement, or participate in preparing any part of the Procurement or any documents or reports related to the Procurement or to which the Procurement refers? No  Yes  **Comments:**
4. Does the Offeror or any Associate of the Offeror have any past, present or currently planned personal or financial interests which are an Actual, Apparent or Potential Conflict of Interest ("Individual" or "Organizational"), with respect to the

ORIGINAL

Procurement or award of this Contract or performing the work for \*PORT AUTHORITY OF GUAM\* or acquisition of any real property for the Project? No  Yes  Comments:

5. Has the Offeror or an Associate of the Offeror offered to a Public Employee, or is the Offeror aware of any Public Employee that has solicited or received, directly or indirectly, any pledge or promise of employment or other benefit based on the understanding that the Public Employee's vote, official action or judgment would be influenced thereby? No  Yes  Comments:

6. Has (or will) the Offeror or an Associate of the Offeror provided a direct beneficial financial interest to any person within two years after the person ceased to hold a position as a Public Employee who was involved in the Procurement or Authorization for the Contract, or is the Offeror aware of any such person or Public Employee who has or will receive a direct beneficial financial interest within the two-year period? No  Yes  Comments:

7. Is the Offeror aware of any current or former Public Employee that has an Actual, Apparent, or Potential Conflict of Interest with respect to the Procurement or award of this Contract or performing the work for \*PORT AUTHORITY OF GUAM\*? No  Yes  Comments:

8. Does the prospective Contract/WOC include development of an Environmental Assessment (EA) or Environmental Impact Statement (EIS)? No  Yes

If yes, in accordance with the disclosure statement requirements of Council on Environmental Quality Regulation, 40 C.F.R 1506.5(c), does the Offeror have any financial or other interest in the outcome of this Project; and/or does the Offeror have any agreement, enforceable promise, or guarantee to provide any future work on this Project?

No  Yes  Comments:

9. Have Subcontractors or other Associates furnished COI Disclosure Forms, separate from the present form, which included conflicts or potential conflicts of interest? (If yes, attach the disclosures.) No  Yes  N/A  Comments:

10. If the prospective Contract/WOC includes personal services for the purpose of administering, managing, monitoring, inspecting, evaluating compliance with or otherwise overseeing a public contract, is the Offeror or an Associate or an Affiliate of the Offeror a party to the subject public contract? No  Yes  N/A  Comments:

11. Has the Offeror or any Associate of the Offeror entered into personal services contract(s) with \*PORT AUTHORITY OF GUAM\* for the purpose of advising or assisting in developing specifications, a scope or statement of work, an invitation to bid, a request for proposals, or other solicitation documents and materials related to this procurement? No  Yes  Comments:

**Relatives and Former \*PORT AUTHORITY OF GUAM\* Employees - Roles and Signatures**

For each employee of the Offeror that was employed by \*PORT AUTHORITY OF GUAM\* within the last year, state the job the employee performed for \*PORT AUTHORITY OF GUAM\*, the role the employee now serves for the Offeror and the date the employee left \*PORT AUTHORITY OF GUAM\*. Use Part B for Offeror Associates with Relatives, Immediate Family Members, or Members of the Household working for \*PORT AUTHORITY OF GUAM\* that have had or will have involvement with this Procurement or Contract.

<b>Part A: Employees that left *PORT AUTHORITY OF GUAM* in the last year.</b>			
<b>Employee Name/Signature</b>	<b>Job Performed for *PORT AUTHORITY OF GUAM*</b>	<b>Current Role with Offeror</b>	<b>Date left *PORT AUTHORITY OF GUAM*</b>
Name: <u>None</u> Sign: _____ <ul style="list-style-type: none"> <li>Involved with this Procurement on behalf of *PORT AUTHORITY OF GUAM*? No <input type="checkbox"/> Yes <input type="checkbox"/></li> <li>Involved with Proposal development for this Procurement? No <input type="checkbox"/> Yes <input type="checkbox"/></li> </ul>	None	None	None
Name: _____ Sign: _____ <ul style="list-style-type: none"> <li>Involved with this Procurement on behalf of *PORT AUTHORITY OF GUAM*? No <input type="checkbox"/> Yes <input type="checkbox"/></li> <li>Involved with Proposal development for this Procurement? No <input type="checkbox"/> Yes <input type="checkbox"/></li> </ul>			
Name: _____ Sign: _____ <ul style="list-style-type: none"> <li>Involved with this Procurement on behalf of *PORT AUTHORITY OF GUAM*? No <input type="checkbox"/> Yes <input type="checkbox"/></li> <li>Involved with Proposal development for this Procurement? No <input type="checkbox"/> Yes <input type="checkbox"/></li> </ul>			
<b>Part B: Identify Associates of the Offeror that are Relatives, Immediate Family Members, or Members of the Household of *PORT AUTHORITY OF GUAM* employees currently working for *PORT AUTHORITY OF GUAM*, if the *PORT AUTHORITY OF GUAM* employee had or will have any involvement with this Procurement or Contract.</b>			
<b>Offeror Associate's Name</b>	<b>Name and Relationship of Relative, Immediate Family Member, or Member of Household Employed at *PORT AUTHORITY OF GUAM*</b>	<b>Role at *PORT AUTHORITY OF GUAM*</b>	<b>*PORT AUTHORITY OF GUAM* employee's Role with this Procurement</b>
None	None	None	None

(Make copies of this form as needed to list additional employees.)

ORIGINAL

**INSTRUCTIONS FOR COMPLETION OF SF-LLL, DISCLOSURE OF LOBBYING ACTIVITIES**

This disclosure form shall be completed by the reporting entity, whether subawardee or prime Federal recipient, at the initiation or receipt of a covered Federal action, or a material change to a previous filing, pursuant to title 31 U.S.C. section 1352. The filing of a form is required for each payment or agreement to make payment to any lobbying entity for influencing or attempting to influence an officer or employee of the Port Authority of Guam, a Member of Congress, an officer or employee of Congress, or an employee of a Member of Congress in connection with a covered Federal action. Complete all items that apply for both the initial filing and material change report. Refer to the implementing guidance published by the Office of Management and Budget for additional information.

1. Identify the type of covered Federal action for which lobbying activity is and/or has been secured to influence the outcome of a covered Federal action.

None

2. Identify the status of the covered Federal action.

None

3. Identify the appropriate classification of this report. If this is a followup report caused by a material change to the information previously reported, enter the year and quarter in which the change occurred. Enter the date of the last previously submitted report by this reporting entity for this covered Federal action.

None

4. Enter the full name, address, city, State and zip code of the reporting entity. Include Congressional District, if known. Check the appropriate classification of the reporting entity that designates if it is, or expects to be, a prime or subaward recipient. Identify the tier of the subawardee, e.g., the first subawardee of the prime is the 1st tier. Subawards include but are not limited to subcontracts, subgrants and contract awards under grants.

None

5. If the organization filing the report in item 4 checks "Subawardee," then enter the full name, address, city, State and zip code of the prime Federal recipient. Include Congressional District, if known.

None

6. Enter the name of the Port Authority of Guam making the award or loan commitment. Include at least one organizational level below the Port Authority of Guam name, if known. For example, Department of Transportation, United States Coast Guard.

None

7. Enter the Federal program name or description for the covered Federal action (item 1). If known, enter the full Catalog of Federal Domestic Assistance (CFDA) number for grants, cooperative agreements, loans, and loan commitments.

None

8. Enter the most appropriate Federal identifying number available for the Federal action identified in item 1 (e.g., Request for Proposal (RFP) number; Invitations for Bid (IFB) number; grant announcement number; the contract, grant, or loan award number; the application/proposal control number assigned by the Federal Port Authority of Guam). Included prefixes, e.g., "RFP-DE-90-001."

None

9. For a covered Federal action where there has been an award or loan commitment by the Port Authority of Guam, enter the Federal amount of the award/loan commitment for the prime entity identified in item 4 or 5.

None

10. (a) Enter the full name, address, city, State and zip code of the lobbying registrant under the Lobbying Disclosure Act of 1995 engaged by the reporting entity identified in item 4 to influence the covered Federal action.

None

(b) Enter the full names of the individual(s) performing services, and include full address if different from 10(a). Enter Last Name, First Name, and Middle Initial (MI).

None

11. The certifying official shall sign and date the form, print his/her name, title, and telephone number.

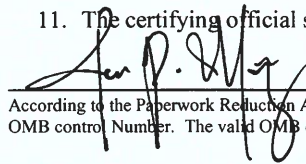

/ Jesse Munoz, Heavy Equipment Sales Manager, (671) 649-1946

According to the Paperwork Reduction Act, as amended, no persons are required to respond to a collection of information unless it displays a valid OMB control Number. The valid OMB control number for this information collection is OMB No. 0348-0046. Public reporting burden for this

**Disclosure of Lobbying Activities**

Complete this form to disclose lobbying activities pursuant to 31 U.S.C. 1352  
(See reverse for public burden disclosure)

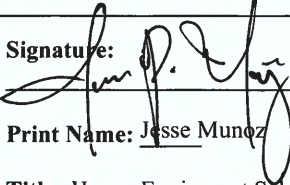
<p>None <b>1. Type of Federal Action:</b> a. contract _____ b. grant c. cooperative agreement d. loan e. loan guarantee f. loan insurance</p>	<p>None <b>2. Status of Federal Action:</b> a. bid/offer/application _____ b. initial award c. post-award</p>	<p>None <b>3. Report Type:</b> a. initial filing _____ b. material change  <b>For material change only:</b> Year _____ quarter _____ Date of last report _____</p>
<p><b>4. Name and Address of Reporting Entity:</b> _____ Prime _____ Subawardee Tier _____, if Known:  None <b>Congressional District, if known:</b></p>	<p><b>5. If Reporting Entity in No. 4 is Subawardee,</b> Enter Name and Address of Prime:  None <b>Congressional District, if known:</b></p>	
<p><b>6. Federal Department/Port Authority of Guam:</b>  None</p>	<p><b>7. Federal Program Name/Description:</b>  CFDA Number, if applicable: _____ None</p>	
<p><b>8. Federal Action Number, if known:</b>  None</p>	<p><b>9. Award Amount, if known:</b> \$ None</p>	
<p><b>10. a. Name and Address of Lobbying Registrant</b> (if individual, last name, first name, MI):  None</p>	<p><b>b. Individuals Performing Services (including address if different from No. 10a)</b> (last name, first name, MI):  None</p>	
<p><b>11. Information requested through this form is authorized by title 31 U.S.C. section 1352. This disclosure of lobbying activities is a material representation of fact upon which reliance was placed by the tier above when this transaction was made or entered into. This disclosure is required pursuant to 31 U.S.C. 1352. This information will be reported to the Congress semi-annually and will be available for public inspection. Any person who fails to file the required disclosure shall be subject to a civil penalty of not less than \$10,000 and not more than \$100,000 for each such failure.</b></p>	<p><b>Signature:</b>  <b>Print Name:</b> Jesse Munoz <b>Title:</b> Heavy Equipment Sales Manager (671) 649-1946 <b>Telephone No.:</b> _____ <b>Date:</b> 02/15/2024</p>	
<p><b>Federal Use Only</b></p>	<p>Authorized for Local Reproduction Standard Form - LLL (Rev. 7-97)</p>	

ORIGINAL

**GOVERNMENT OF GUAM  
GENERAL TERMS AND CONDITIONS**

SEALED BID SOLICITATION AND AWARD

**Only those Boxes checked below are applicable to this bid.**

- [X] 1. **AUTHORITY:** This solicitation is issued subject to all the provision of the Guam Procurement Act (5GCA, Chapter 5) and the Guam Procurement Regulations (copies of both are available at the Office of the Complier of laws, Department of Law, copies available for inspection at the PORT AUTHORITY OF GUAM). It requires all parties involved in the Preparation, negotiation, performance, or administration of contracts to act in good faith.
- [X] 2. **GENERAL INTENTION:** Unless otherwise specified, it is the declared and acknowledged intention and meaning of these General Terms and conditions for the bidder to provide the Government of Guam (Government) with specified services or with materials, supplies or equipment completely assembled and ready for use.
- [X] 3. **TAXES:** Bidders are cautioned that they are subject to Guam Income Taxes as well as all other taxes on Guam Transactions. Specific information on taxes may be obtained from the Director of Revenue and Taxation.

**WITHHOLDING ASSESSMENT FEE:**

All agencies, to include autonomous agencies, of the government of Guam shall ensure that all Requests for Proposals (RFP) and Invitations for Bid (IFB) must include the notification to potential offerors that the award and issuance of a contract to provide the professional services is subject to the withholding assessment fee for contracts awarded to persons without a valid Guam business license, as follows: all procurements of professional services are subject to a withholding assessment fee for non-resident persons or companies without a valid Guam Business License, which is equal to four percent (4%) of the total dollar value of any contract awarded for all government of Guam contracts for any professional services provided by a non-resident person or company residing outside of Guam, as a cost of doing business with the government of Guam, in accordance with 11 GCA § 71114 (P.L. 33-166)."

- [X] 4. **LICENSING:** Bidders are cautioned that the Government will not consider for award any offer submitted by a bidder who has not complied with the Guam Licensing Law. Specific information on licenses may be obtained from the Director of Revenue and Taxation.
- [X] 5. **NO LOCAL PROCUREMENT PREFERENCE:** There is no geographical preference for this IFB in compliance with 2 CFR § 200.319(c) and the terms and conditions of MARAD FY2022 American Marine Highway (AMH) Grant No.: 693JF72340007; however, no specification, term, condition, or qualification of this IFB shall exclude any Offeror from consideration on the basis of Guam-only experience provided that the experience of such Offeror is otherwise responsive to the solicitation, in accordance with the requirements of 5 GCA § 5008(e).
- [X] 6. **COMPLIANCE WITH SPECIFICATIONS AND OTHER SOLICITATION REQUIREMENTS:** Bidders shall comply with all specifications and other requirements of the Solicitation.
- [X] 8. **"ALL OR NONE" BIDS:** NOTE: By checking this item, the Government is requesting all of the bid items to be bid or none at all.  
The Government will not award on an itemized basis.
- [X] 9. **INDEPENDENT PRICE DETERMINATION:** The bidder, upon signing the Invitation for Bid, certifies that the prices in his bid were derived at without collusion, and acknowledge that collusion and anti-competitive practices are prohibited by law. Violations will be subject to the provision of Section 5651 of that of the Guam Procurement Act. Other existing civil, criminal or administrative remedies are not impaired and may be in addition to the remedies in Section 5651 of the Government code.



- [X] 10. **BIDDER'S PRICE:** The Government will consider not more than one (1) (base bid) item prices and the bidder shall explain fully each price if supplies, materials, equipment, and/or specified services offered comply with specifications and the products origin. Where basic bid meets the minimum required specification, cost and other factors will be considered.
- [X] 11. **BID ENVELOPE:** Envelope shall be sealed and marked with the bidder's name, bid number, time, date. Bid may be submitted before the deadline and stamped received via mail, but must be prior to bid opening date and time. If received after, it shall be stamped with the date and time was received, and returned as rejected,
- [X] 12. **BID GUARANTEE REQUIREMENT:** Bidder is required to submit a Bid Guarantee Bond or standby irrevocable Letter of Credit or Certified Check or Cashier's Check in the same bid envelope to be held by the Government pending award. The Bid Guarantee Bond, Letter of Credit, Certified Check or Cashier's Check must be issued by any local surety or banking institution licensed to do business on Guam and made payable to the Treasure of Guam in the amount of fifteen percent (15%) of his highest total bid offer. The Bid Bond must be submitted on Government Standard Form BB-1 (copy enclosed). Personal Checks will not be accepted as Bid Guarantee. If a successful Bidder (contractor) withdraws from the bid or fails to enter into contract within the prescribed time, such Bid guarantee will be forfeited to the Government of Guam. Bids will be disqualified if not accompanied by Bid Bond, Letter of Credit, Certified Check or Cashier's check. Bidder must include in his/her bid, valid copies of a Power of Attorney from the Surety and a Certificate of Authority from the Government of Guam to show proof that the surety company named on the bond instrument is authorized by the Government of Guam and qualified to do business on Guam. For detailed information on bonding matters, contact the Department of Revenue and Taxation. Failure to submit a valid Power of Attorney and Certificate of Authority on the surety is cause for rejection of bid. **Pursuant to 5 GCA § 5212, all competitive sealed bidding for the procurement of supplies or services exceeding \$25,000.00 a 15% Bid Security of the total bid price must accompany the bid package. The bid bond, Letter of Credit, Certified Check or Cashier's Check will serve as Bid Security for this procurement.**
- [X]13. **PERFORMANCE GUARANTEE:** Bidders who are awarded a contract under this solicitation, guarantee that goods will be delivered or required services performed within the time specified. Failure to perform the contract in a satisfactory manner may be cause for suspension or debarment from doing business with the Government of Guam. In addition, the Government will hold the Vendor liable and will enforce the requirements as set forth in Section 40 of these General Terms and Conditions.
- [X] 14. **SURETY BONDS:** Bid and Bid Bonds coverage must be signed or countersigned in Guam by a foreign or alien surety's resident general agent. The surety must be an Insurance Company, authorized by the government of Guam and qualified to do business in Guam. Bids will be disqualified if the Surety Company does not have a valid Certificate of Authority from the Government of Guam to conduct business in Guam.
- [X] 15. **COMPETENCY OF BIDDERS:** Bids will be considered only from such bidders who, in the opinion of the Government, can show evidence of their ability, experience, equipment, and facilities to render satisfactory service.
- [X] 16. **DETERMINATION OF RESPONSIBILITY OF BIDDERS:** The GENERAL MANAGER reserves the right for securing from Bidders information to determine whether or not they are responsible and to inspect plant site, place of business; and supplies and services as necessary to determine their responsibility in accordance with Section 15 of these General Terms and Conditions.  
(2 GAR, Div. 4 § 3116)
- [X] 17. **STANDARD FOR DETERMINATION OF LOWEST RESPONSIBLE BIDDER:**  
In determining the lowest responsible offer, the GENERAL MANAGER shall be guided by the following:
- a) Price of items offered.
  - b) The ability, capacity, and skill of the Bidder to perform.
  - c) Whether the Bidder can perform promptly or within the specified time.
  - d) The quality of performance of the Bidder with regards to awards previously made to him.
  - e) The previous and existing compliance by the Bidder with laws and regulations relative to procurement.
  - f) The sufficiency of the financial resources and ability of the Bidder to perform.
  - g) The ability of the bidder to provide future maintenance and services for the subject of the award.

- h) The compliance with all of the conditions to the Solicitation.
- [X] 18. **TIE BIDS:** If the bids are for the same unit price or total amount in the whole or in part, the GENERAL MANAGER will determine award based on 2 GAR, Div. 4, § 3109(o) (2) or to reject all such bids.
- [X] 19. **BRAND NAMES:** Any reference in the Solicitation to manufacturer's Brand Names and number is due to lack of a satisfactory specification of commodity description. Reference is intended to be descriptive, but not restrictive and for the sole purpose of indicating prospective bidders a description of the article or services that will be satisfactory. Bids on comparable items will be considered provided the bidder clearly states in his bid the exact articles he is offering and how it differs from the original specification.
- [X] 20. **DESCRIPTIVE LITERATURE:** Descriptive literature(s) as specified in this solicitation must be furnished as a part of the bid and must be received at the date and time set for opening Bids. The literature furnished must clearly identify the item(s) in the Bid. The descriptive literature is required to establish, for the purpose of evaluation and award, details of the product(s) the bidder proposes to furnish including design, materials, components, performance characteristics, methods of manufacture, construction, assembly or other characteristics which are considered appropriate. Rejection of the Bid will be required if the descriptive literature(s) do not show that the product(s) offered conform(s) to the specifications and other requirements of this solicitation. Failure to furnish the descriptive literature(s) by the time specified in the Solicitation will require rejection of the bid.
- [ ] 21. **SAMPLES:** Sample(s) of item(s) as specified in this solicitation must be furnished as a part of the bid and must be received at the date and time set for opening Bids. The sample(s) should represent exactly what the bidder proposes to furnish and will be used to determine if the item(s) offered complies with the specifications. Rejection of the Bid will be required if the sample(s) do not show that the product(s) offered conform(s) to the specifications and other requirements of this solicitation. Failure to furnish the sample(s) by the time specified in the Solicitation will require rejection of the Bid.
- [ ] 22. **LABORATORY TEST:** Successful bidder is required to accompany delivery of his goods with a Laboratory Test Report indicating that the product he is furnishing the Government meets with the specifications. This report is on the bidder's account and must be from a certified Testing Association.
- [X] 23. **AWARD, CANCELLATION, & REJECTION:** Award shall be made to the lowest responsible and responsive bidder, whose bid is determined to be the most advantageous to the Government, taking into consideration the evaluation factors set forth in this solicitation. No other factors or criteria shall be used in the evaluation. The right is reserved as the interest of the Government may require to waive any minor irregularity in bid received. The GENERAL MANAGER shall have the authority to award, cancel, or reject bids, in whole or in part for any one or more items if he determines it is in the public interest. Award issued to the lowest responsible bidder within the specified time for acceptance as indicated in the solicitation, results in a bidding contract without further action by either party. In case of an error in the extension of prices, unit price will govern. It is the policy of the Government to award contracts to qualified local bidders. The Government reserves the right to increase or decrease the quantity of the items for award and make additional awards for the same type items and the vendor agrees to such modifications and additional awards based on the bid prices for a period of thirty (30) days after original award. No award shall be made under this solicitation which shall require advance payment or irrevocable letter of credit from the government (2 GAR, Div.4 §1103).
- [ ] 24. **MARKING:** Each outside container shall be marked with the Purchase Order number, item number, brief item description and quantity. Letter marking shall not be less than 3/4" in height.
- [X] 25. **SCHEDULE FOR DELIVERY:** Successful bidder shall notify the PORT AUTHORITY OF GUAM, Telephone Nos. 477-5931, at least twenty-four (24) hours before delivery of any item under this solicitation.
- [ ] 26. **BILL OF SALE:** Successful supplier shall render Bills of Sale for each item delivered under this contract. Failure to comply with this requirement will result in rejection of delivery. The Bill of Sale must accompany the items delivered but will not be considered as an invoice for payment. Supplier shall bill the Government in accordance with billing instructions as indicated on the Purchase Order.
- [ ] 26. **MANUFACTURER'S CERTIFICATE:** Successful bidder is required, upon delivery of any item under this contract, to furnish a certificate from the manufacturer indicating that the goods meet the

specifications. Failure to comply with this request will result in rejection of delivery payment. Supplier shall bill the Government in accordance with billing instructions as indicated on the Purchase Order.

[X] 27. **INSPECTION:** All supplies, materials, equipment, or services delivered under this contract shall be subject to the inspection and/or test conducted by the Government at destination. If in any case the supplies, materials, equipment, or services are found to be defective in material, workmanship, performance, or otherwise do not conform with the specifications, the Government shall have the right to reject the items or require that they be corrected. The number of days required for correction will be determined by the Government.

[ ] 28. **MOTOR VEHICLE SAFETY REQUIREMENTS:** The Government will only consider Bids on motor vehicles which comply with the requirements of the National Traffic and Motor Vehicle safety Act of 1966 (Public Law 89-563) and Clean Air Act as amended (Public Law 88-206), that are applicable to Guam. Bidders shall state if the equipment offered comply with these aforementioned Federal Laws.

[ ] 29. **SAFETY INSPECTION:** All motor vehicles delivered under this contract must pass the Government of Guam Vehicle Inspection before delivery at destination.

[X] 30. **GUARANTEE:**

**a) Guarantee of Vehicle Type of Equipment:**

The successful bidder shall guarantee vehicular type of equipment offered against defective parts, workmanship, and performance, for a period of not less than one (1) year after date of receipt of equipment. Bidder shall also provide service to the equipment for at least one (1) year. Service to be provided shall include, but will not be limited to tune ups (change of spark plugs, contact points and condensers) and lubrication (change of engine and transmission oil). All parts and labor shall be at the expense of the bidder. All parts found defective and not caused by misuse, negligence or accident within the guarantee period shall be repaired, replaced, or adjusted within six (6) working days after notice from the Government and without cost to the Government. Vehicular type of equipment as used in this context shall include equipment used for transportation as differentiated from tractors, backhoes, etc.

**b) Guarantee of Other Type of Equipment:**

The successful bidder shall guarantee all other types of equipment offered, except those mentioned in 30a, above, against defective parts, workmanship, and performance for a period of not less than three (3) months after date of receipt of equipment. Bidder shall also provide service to the equipment for at least three (3) months. All parts found defective within that period shall be repaired or replaced by the Contractor without cost to the Government. Repairs, adjustments or replacements of defective parts shall be completed by the contractor within six (6) working days after notice from the Government.

**(c) Compliance with this Section is a condition of this Bid.**

[X] 31. **REPRESENTATION REGARDING ETHICS IN PUBLIC PROCUREMENT:** The bidder or contractor represents that it has not knowingly influenced and promises that it will not knowingly influence a Government employee to breach any of the ethical standards and represents that it has not violated, is not violating, and promises that it will not violate the prohibition against gratuities and kickbacks set forth on Chapter 11 (Ethics in Public Contracting) of the Guam Procurement Act and in Chapter 11 of the Guam Procurement Regulations.

[X] 32. **REPRESENTATION REGARDING CONTINGENT FEES:** The contractor represents that it has not retained a person to solicit or secure a Government contract upon an agreement or understanding for a commission, percentage, brokerage, or contingent fee, except for retention of bona fide employees or bona fide established commercial selling agencies for the purpose of securing business (GPR Section 11-207).

[X] 33. **EQUAL EMPLOYMENT OPPORTUNITY:** Contractors shall not discriminate against any employee or applicant of employment because of race, color, religion, sex, or national origin. The contractor will take affirmative action to ensure that employees are treated equally during employment without regards to their race, color, religion, sex, or national origin.

ORIGINAL

- [X] 34. **COMPLIANCE WITH LAWS:** Bidders awarded a contract under this Solicitation shall comply with the applicable standard, provisions, and stipulations of all pertinent Federal and/or local laws, rules, and regulations relative to the performance of this contract and the furnishing of goods.
- [ ] 35. **CHANGE ORDER:** Any order issued relative to awards made under this solicitation will be subject to and in accordance with the provisions of Section 6-101-03.1 of the Guam Procurement Regulations.
- [X] 36. **STOP WORK ORDER:** Any stop work order issued relative to awards made under this solicitation will be subject to and in accordance with the provisions of Section 6-101-04.1 of the Guam Procurement Regulations.
- [X] 37. **CANCELLATION OF INVITATION FOR BIDS OR REQUEST FOR PROPOSALS:** Any Invitation for Bid may be cancelled, or any or all bids or proposals may be rejected in whole or in part as may be specified in the solicitation, when it is in the best interests of the Territory in accordance with regulations promulgated by the Policy Office. The reasons therefor shall be made part of the contract file.

Contract will be cancelled if funds not appropriated or insufficient, and that government will timely inform contractor. 2 GAR, Div.4 §3121(e) (1) (C) and 2 GAR, Div.4 § 3121(e)(1)(D).

If cancelled, contractor will be reimbursed unamortized reasonably incurred non-recurring costs. 2 GAR, Div.4 § 3121(e) (1) (G).

- [X] 38. **TIME FOR COMPLETION:** It is hereby understood and mutually agreed by and between the contractor and the Government that the time for delivery to final destination or the timely performance of certain services is an essential condition of this contract. If the contractor refuses or fails to perform any of the provisions of this contract within the time specified in the Purchase Order (from the date Purchase Order is acknowledged by vendor), then the contractor is in default. Defaults will be treated subject to and in accordance with the provisions of 2 GAR, Div. 4 § 6101(8)
- [X] 39. **JUSTIFICATION OF DELAY:** Bidders who are awarded contracts under this Solicitation, guarantee that the goods will be delivered to their destination or required services rendered within the time specified. If the bidder is not able to meet the specified delivery date, he is required to notify the GENERAL MANAGER of such delay. Notification shall be in writing and shall be received by the GENERAL MANAGER at least twenty-four (24) hours before the specified delivery date. Notification of delay shall include an explanation of the causes and reasons for the delay including statement(s) from supplier or shipping company causing the delay. The Government reserves the right to reject delay justification if, in the opinion of the GENERAL MANAGER, such justification is not adequate.
- [X] 40. **SERVICE-DISABLED VETERAN OWNED BUSINESS PREFERENCE:** Bidding is subject to the policy in favor of Service-Disabled Veteran Owned Business as defined in 5 GCA sections 5011 and 5012.
- [X] 41. **LIQUIDATED DAMAGES:** When the contractor is given notice of delay or nonperformance as specified in Paragraph 1 (Default) of the Termination for Default Clause of this contract and fails to cure in the time specified, the contractor shall be liable for damages for delay in the amount of one-fourth of one percent (1%) of outstanding order per calendar day from date set for cure until either the territory reasonable obtains similar supplies or services if the contractor is terminated for default, or until the contractor provides the supplies or services if the contractor is not terminated for default. To the extent that the contractor's delay or nonperformance is excused under Paragraph 40 (Excuse for Nonperformance or Delayed Performance) of the Termination for Default Clause of this contract, liquidated damages shall not be due the territory. The contractor remains liable for damages caused other than by delay. **2 GAR, Div. 4 §6101(d).**
- [X] 42. **PHYSICAL LIABILITY:** If it becomes necessary for the Vendor, either as principal, agent or employee, to enter upon the premises or property of the Government of Guam in order to construct, erect, inspect, make delivery or remove property hereunder, the Vendor hereby covenants and agrees to take, use, provide and make all proper, necessary and sufficient precautions, safeguards and protections against the occurrence of any accidents, injuries or damages to any person or property during the progress of the work herein covered, and to be responsible for, and to indemnify and save harmless the Government of Guam from the payment of all sums of money by reason of all or any such accidents, injuries or damages that may occur upon or about such work, and fines, penalties and loss incurred for or by reasons of the violations of any territorial ordinance, regulations, or the laws of Guam or the United States, while the work is in progress. Contractor will carry insurance to indemnify the Government of

Guam against any claim for loss, damage or injury to property or persons arising out of the performance of the Contractor or his employees and agents of the services covered by the contract and the use, misuse or failure of any equipment used by the contractor or his employees or agents, and shall provide certificates of such insurance to the Government of Guam when required.

[X] 43. **INSURANCE COVERAGE REQUIRED:** The amount of insurance required shall be determined by the Port's General Manager depending upon the type of activity conducted, or to be conducted by the owners or operators of vehicles entering the Port's facilities other service providers accessing on foot.

- A. Commercial General Liability including Broad Form Property Damage and Contractual Liability \$1,000,000.00 combined single limit of liability
- B. Worker's Compensation – Statutory
- C. Automobile Liability - \$1,000,000.00 combined single limit of liability

Insurance Company: The insurance coverage(s) must be issued by those insurance companies who are licensed to do business on Guam, as determined by the Insurance Commissioner of the Department of Revenue and Taxation.

Additional Insurance Provision: All Commercial insurance policies possessed by owners or operators of vehicles entering or using the Port's facilities and/or grounds must name the Port as an additional Insured in their policies and specify that the Port shall be given at least thirty (30 days' prior written notice of any cancellation, material change or reduction in coverage.

Proof of Insurance: An Insurance Certificate must be issued listing all the vehicles, equipment, trucks covered under the insurance policy and filed with the Port Police Division. The insurance should include;

Name of the Insured (The Port must be shown as an Additional Insured on all Commercial insurance policies)

- Policy Number
- Effective Date of Policy
- Limits of Insurance
- Description of Coverage Provided; and
- Name of Issuing Company

A certified copy of the Insurance Certificate must be carried in each vehicle, equipment and/or truck entering the Port facilities. This proof of insurance must be provided to the Port Police Division on an annual basis at least ten (10) days before the insurance policy expires.

Notice of Loss: In the event a Port tenant or user is involved in an accident within the Port's facilities or while on Routes 11A or 11B (Cabras Highway) and results in bodily injury or property damage, the Port Police Division must be immediately notified.

Workers' Compensation: All business entitles entering or using the Port's facilities must also possess Workers' Compensation Insurance coverage as prescribed by Guam laws and copies of such Certificate of Insurance are to be filed with the Port Police Division. Each certification shall specify that the Port shall be given at least thirty (30) days prior written notice of any cancellation, material change or reduction in coverage.

Interchange Agreement: In lieu of fulfilling the maximum the maximum insurance requirements listed herein, the Port user must provide to the Port a current Interchange Agreement. The primary company must have fulfilled the maximum insurance requirements listed above. The Interchange Agreement must specifically state and name the Port user as additional insured and the duration of coverage. The Port must be notified thirty (30) days prior written notice of any cancellation, materials change or reduction in coverage.

[X] 44. Contract will be cancelled if funds not appropriated or insufficient, and that government will timely inform contractor. 2 GAR, Div. 4 §3121(e) (1)(C) and 2 GAR, Div. 4 § 3121(e) (1) (D)

[ ] 45. If cancelled, contractor will be reimbursed unamortized reasonably incurred non-recurring costs. 2 GAR, Div. 4 §3121(e) (1) (G)

[X] 46. **CONTACT FOR CONTRACT ADMINISTRATION:** If your firm receives a contract as a result of this Solicitation, please designate a person whom we may contact for prompt administration.

ORIGINAL

- [X] 47. **WOMEN-OWNED BUSINESS PREFERENCE:** Bidding is subject to the policy in favor of Women-Owned Businesses pursuant to “*The Support for Women-Owned Business Act*” enacted by Public Law No. 36-26 and codified in 5 GCA section 5013.
- [X] 48. **FEDERAL GSA SCHEDULES:** This IFB is federally funded under MARAD FY2022 American Marine Highway (AMH) Grant No.: 693JF72340007. The Port Authority of Guam is accepting Federal GSA pricing inclusive with shipping cost to Guam. If the bid pricing existing on the Federal GSA website from a qualified vendor for qualifying items on the date of opening of the bids, plus the confirmed price of shipping costs to Guam, confirmed after the opening of the bids, is the lowest price, then the contract will be awarded to that vendor.
- [X] 49. **MULTI-TERM CONTRACT:** (A) the amount of supplies or services required for the proposed contract period; (B) that a unit price shall be given for each supply or service, and that such unit prices shall be the same throughout the contract (except to the extent price adjustments may be provided in the solicitation and resulting contract); (C) that the multi-term contract will be cancelled only if funds are not appropriated or otherwise made available to support continuation of performance in any fiscal period succeeding the first; however, this does not affect either the territory's rights or the contractor's rights under any termination clause in the contract; (D) that the Procurement Officer must notify the contractor on a timely basis that the funds are, or are not, available for the continuation of the contract for each succeeding fiscal period; (E) whether bidders or offerors may submit prices for: (i) the first fiscal period only; (ii) the entire time of performance only; or (iii) both the first fiscal period and the entire time of performance; (F) that a multi-term contract may be awarded and how award will be determined including, if prices for the first fiscal period and entire time of performance are submitted, how such prices will be compared; and in the event that funds are not available for any succeeding fiscal period, the remainder of such contract shall be cancelled and the contractor shall be reimbursed the reasonable value of any nonrecurring costs incurred but not amortized in the price of the supplies delivered or services performed under the contract.

Name: Jesse Munoz Title: Heavy Equipment Sales Manager  
Address: 197 Ypao Road, Tamuning, Guam 96913 Telephone: (671) 649-1946

ORIGINAL

GOVERNMENT OF GUAM

SEALED BID SOLICITATION INSTRUCTIONS

1. **BID FORMS:** Each bidder shall be provided with one (1) set of solicitation forms. Additional hard copies may be provided upon request. Bidders requesting additional copies of said forms will be charged per page in accordance with 5 GCA § 10203 of the Government Code of Guam. All payments for this purpose shall be by cash, certified check or money order and shall be made payable to the PORT AUTHORITY OF GUAM (EO 86-24).
2. **PREPARATIONS OF BIDS:**
  - 2.0 Bidders are required to examine the drawings, specifications, schedule, and all instructions. Failure to do so will be at bidder's risk.
  - 2.1 Each bidder shall furnish the information required by the Solicitation. The bidder shall sign the Solicitation and print or type his name on the Schedule. Erasures or other changes must be initialed by the person signing the bid. Bids signed by an agent are to be accompanied by evidence of this authority unless such evidence has been previously furnished to the issuing office.
  - 2.2 Unit price for each unit offered shall be shown and such price shall include packing unless otherwise specified. A total shall be entered in the amount column of the Schedule for each item offered. In case of discrepancies between a unit price and extended price, the unit price will be presumed to be correct.
  - 2.3 Bids for supplies or services other than those specified will not be considered. Time, if stated as a number of days, means calendar days and will include Saturdays, Sundays, and holidays beginning the day after the issuance of a Notice to Proceed. Time stated ending on a Saturday, Sunday or Government of Guam legal holiday will end at the close of the next business day.
  - 2.4 No Entitlement To Preparation Costs – the bidder expressly waives any right it may have against the government for any expenses incurred in connection with the preparation of its bid.
3. **EXPLANATION TO BIDDERS:** Any explanation desired by a bidder regarding the meaning or interpretation of the Solicitation, drawings, specifications, etc., must be submitted in writing and with sufficient time allowed for a written reply to reach all bidders before the submission of their bids. Oral explanations or instructions given before the award of the contract will not be binding. Any information given to a prospective bidder concerning a Solicitation will be furnished to all prospective bidders in writing as an amendment to the Solicitation if such information would be prejudicial to informed bidders.
4. **ACKNOWLEDGEMENT OF AMENDMENTS TO SOLICITATIONS:** Receipt of an amendment to a Solicitation by a bidder must be acknowledged by signing an acknowledgement of receipt of the amendment. Such acknowledgement must be received prior to the hour and date specified for receipt of bids.
5. **SUBMISSION OF BIDS:**
  - a) Bids and modifications thereof shall be enclosed in sealed envelopes and addressed to the office specified in the Solicitation. The bidder shall show the hour and date specified in the Solicitation for receipt, the Solicitation number, and the name and address of the bidder on the face of the envelope.
  - b) Telegraphic or e-mailed bids will not be considered, all bidders must submit in a sealed envelope by or before the date and time bids are due. However, bids may be modified or withdrawn by written or telegraphic notice, provided such notice is received prior to the hour and date specified for receipt (see paragraph 6 of these instructions).
  - c) Samples of items, when required, must be submitted within the time specified, unless otherwise specified by the Government, at no expense to the Government. If not destroyed by

testing, samples will be returned at bidder's request and expense, unless otherwise specified by the Solicitation.

- d) Descriptive literature should be submitted as required on this solicitation. Descriptive literature will be examined or tested at the bidder's risk, and will not be deemed to vary any of the provisions of this solicitation.
6. **Multiple or Alternate Bids or Proposals:** At least one (1) multiple or alternate bid will be accepted. It must be marked on the packet as alternate and your base bid must be marked as primary, placed in separate sealed envelopes. Alternate bids shall only be considered for award if the bidder's primary bid is the lowest responsive and responsible bid.
7. **FAILURE TO SUBMIT BID:** If no bid is to be submitted, do not return the solicitation unless otherwise specified. A letter or postcard shall be sent to the issuing office advising whether future Solicitations for the type of supplies or services covered by this Solicitation are desired.
8. **LATE BID, LATE WITHDRAWALS, AND LATE MODIFICATIONS:**
- a) Definition: Any bid received after the time and date set for receipt of bids is late. Any withdrawal or modification of a bid received after the time and date set for opening of bids at the place designated for opening is late (Guam Procurement Regulations 2 GAR, Div.4 §3109(k)).
- b) Treatment: No late bid, late modification, or late withdrawal will be considered unless received before contract award, and the bid, modification, or withdrawal would have been timely but for the action or inaction of territorial personnel directly serving the procurement activity.
9. **DISCOUNTS:**
- a) Notwithstanding the fact that prompt payment discounts may be offered, such offer will not be considered in evaluating bids for award unless otherwise specified in the Solicitation. However, offered discounts will be taken if payment is made within the discount period, even though not considered in the evaluation of bids.
- b) In connection with any discount offered, time will be computed from date of delivery and acceptance of the supplies to the destination as indicated in the purchase order or contract. Payment is deemed to be made for the purpose of earning the discount on the date of mailing of the Government check.
9. **GOVERNMENT FURNISHED PROPERTY:** No material, labor or facilities will be furnished by the Government unless otherwise provided for in the Solicitation.
10. **SELLER' INVOICES:** Invoices shall be prepared and submitted in quadruplicate (one copy shall be marked "original") unless otherwise specified. Invoices shall be "certified true and correct" and shall contain the following information: Contract and order number (if any), item numbers, description of supplies or services, sizes, quantities, unit prices, and extended total. Bill of lading number and weight of shipment will be shown for shipments made on Government bills of lading.
11. **RECEIPT, OPENING AND RECORDING OF BIDS:** Bids and modifications shall be publicly opened in the presence of one or more witnesses, at the time, date, and place designated in the Invitation for Bids. The name of each bidder, the bid price, and such other information as is deemed appropriate by the Procurement Officer, shall be read aloud and recorded, or otherwise made available. The names and addresses of required witnesses shall be recorded at the opening. The opened bids shall be available for public inspection except to the extent the bidder designates trade secrets or other proprietary data to be confidential as set forth in accordance with Section 12, below. Material so designated shall accompany the bid and shall be readily separable from the bid in order to facilitate public inspection of the non-confidential portion of the bid. Prices, makes and models or catalogue numbers of the items offered, deliveries, and terms of payment shall be publicly available at the time of bid opening regardless of any designation to the contrary (Guam Procurement Regulations 2 GAR, Div.4 §3109(k)).
12. **CONFIDENTIAL DATA:** If a bidder considers any information submitted in its bid to be confidential, the bidder



must identify in writing to the Government those portions which it considers confidential, and must request in writing that those portions be kept confidential. Only trade secrets and proprietary data will be considered confidential. If there is a request for confidentiality, the Government will render a decision on the request as soon as practicable after bids are opened. The Government will advise any bidder requesting confidentiality, of the Government's decision in writing. If the Government does not agree with a bidder's request, then the Government will inform the bidder that it may lodge a protest regarding any part of the Government's decision by following the procedure for protests outlined in Chapter 9 of the Guam Procurement Regulations.

13. **PROHIBITION AGAINST GRATUITIES AND KICKBACKS:** With respect to this procurement and any other contract that bidder may have or wish to enter into with the Government, the bidder represents that he/she has not violated, is not violating, and promises that he will not violate the prohibition against gratuities and kickbacks set forth in the Guam Procurement Regulations.

14. **WAGE AND BENEFIT COMPLIANCE-CONTRACTORS PROVIDING SERVICES**

- a) Contractor with regard to all person its employs whose purpose in whole or in part is the direct delivery of services contracted for with the Government of Guam in this procurement, shall pay such employees in accordance with the Wage Determination for Guam and the Northern Marianas Islands issued and promulgated by the U.S. Department of Labor for such labor as is employed in the direct deliverance of deliverables to the government of Guam. 5 GCA § 5801 Contractor shall be responsible for flowing down this obligation to its subcontractors.
- b) The Wage Determination most recently issued by the U.S. Department of Labor at the time this Agreement was awarded to Contractor shall be used to determine wages and benefits which shall be paid to employees pursuant to this clause. 5 GCA § 5801
- c) Should any contract contain a renewal clause, then at the time of renewal adjustments there shall be stipulations contained in that contract for applying the Wage Determination, so that the Wage Determination promulgated by the U.S Department of Labor on a date most recent to the renewal date shall apply. 5 GCA § 5801
- d) In addition to the Wage Determination detailed above, health and similar benefits for employees having a minimum value as detailed in the Wage Determination issued and promulgated by the U.S. Department of Labor shall apply. Contractor shall pay a minimum of ten (10) paid holidays per annum per employee. 5 GCA § 5802
- e) Any violation of Contractor or its subcontractor's obligations of this section shall be investigated by the Guam Department of Labor and may include a monetary penalty assessment by the Guam Department of Labor of no less than One Hundred Dollars (\$100.00) per day, and no more than One Thousand Dollars (\$1,000.00) per day, until such time as a violation has been corrected, as well as the payment of all back wages and benefits due. 5 GCA § 5803
- f) In addition to any and all other breach of contract actions the Government of Guam may have under this procurement, in the event there is a violation in the process set forth in subsection (e) above, Contractor may be placed on probationary status by the GENERAL MANAGER of the General Service Agency, or its successor, for a period of one (1) year.

During the probationary status, a Contractor shall not be awarded any contract by any instrumentality of the Government of Guam. A Contractor who has been placed on probationary status, or has been assessed a monetary penalty pursuant to 5 G.C.A. Article 13 Title 5 may appeal such penalty or probationary status to the Superior Court of Guam. 5 GCA § 5804

- g) Contractor along with all proposed Offerors and submitter under this procurement were required to submit a Declaration of Compliance with Wage Determination laws as part of this procurement with a copy of the most recent Wage Determination for Guam and the Northern Marianas Islands issued and promulgated by the U.S. Department of Labor. 5 GCA §5805
- h) The applicable USDOL Wage Determination Rate Revision (as defined by subsections (b) and (c)) is to this Agreement. Contractor agrees to provide upon written request by the Government of Guam written certification of its compliance with its obligations as part of each invoice, along with the names of any employees, their positions, and detailed wage and benefits paid in keeping with this section. Additionally, upon request by Government of Guam the Contractor shall submit

ORIGINAL

source documents as to those individuals provide direct services in part or whole under this Agreement and its payments to them of such wages and benefits.

15. **ETHICAL STANDARDS:** With respect to this procurement and any other contract that the Contractor may have, or wish to enter into, with any government of Guam agency, the Contractor represents that it has not knowingly influenced, and promises that it will not knowingly influence, any government employee to breach any of the ethical standards set forth in the Guam Procurement Law and in any of the Guam Procurement Regulations.
16. **PROHIBITION AGAINST CONTINGENT FEES:** The Contractor represents that he has not retained any person or agency upon an agreement or understanding for a percentage, commission, brokerage, or other contingent arrangement, except for retention of bona fide employees or bona fide established commercial selling agencies, to solicit or secure this Agreement or any other contract with the government of Guam or its agencies.
17. **CONTRACTOR'S WARRANTY AS TO EMPLOYEES AND SEX OFFENSES. Reference 5 GCA 5253 (b)**  
Contractor warrants that no person providing services on behalf of the Contractor has been convicted of a sex offense under the provisions of Chapter 25 of Title 9 of GCA or an offense as defined in Article 2 of Chapter 28, Title 9 GCA, or an offense in another jurisdiction with, at a minimum, the same elements as such offenses, or who is listed on the Sex Offender Registry.

Contractor warrants that if any person providing services on behalf of Contractor is convicted of a sex offense under the provisions of Chapter 25 of Title 9 GCA, or an offense as defined in Article 2 of Chapter 28, Title 9 GCA, or an offense in another jurisdiction with, at a minimum, the same elements as such offenses, or who is listed on the Sex Offender Registry, that such person will be immediately removed from working at said agency and that the administrator of said agency be informed of such within twenty-four (24) hours of such conviction. Any contractor found in violation of this section, after notice from the Government of Guam, after notice from the contracting authority of such violation, shall within twenty-four (24) hours, take corrective action and shall report such action to the contracting authority. Failure to take corrective action with the stipulated period may result in the temporary suspension of the contract at the discretion of the Government of Guam.

18. **POLICY IN FAVOR OF SERVICE-DISABLED VETERAN OWNED BUSINESSES** P.L. 31-115 (September 20, 2011) 5 GCA § 5011 and § 5012 In the procurement of any supply or service, (except for professional services), if such supply or service is offered by a Service-Disabled Veteran Owned Business "SDVOB", as defined in 5 GCA § 5012, that is at least fifty one percent (51%) owned by service-disabled veteran(s), and if the supply or service is available within the period that is required for the procurement, and the price for the supply or service does not exceed one hundred five percent (105%) of the lowest bidder price, a preference shall be given to that SDVOB by the Government of Guam, and the supply or service shall be purchased from said SDVOB. This shall be in addition to any other procurement benefit the SDVOB may qualify for under Guam law. A business concern is a qualified SDVOB if: (a) the business concern is licensed to do business on Guam; (b) the business concern maintains its headquarters on Guam; (c) the business concern is at least fifty-one (51%) owned by a service-disabled veteran(s) who served in the active U.S. military service, was discharged or released under honorable conditions and whose disability is service-connected as demonstrated by a DD214, and certified by an award letter from the U.S. Department of Veterans Affairs; the DD214 and Disability award letter from U.S. Department of Veterans Affairs are submitted to the Government of Guam procuring agency for every service offered; and the service disabled veteran(s) owner(s) of the business concern has filed individual tax returns on Guam for a period of at least three (3) consecutive years.
19. **Policy In Favor of Women-Owned Businesses** (a) Notwithstanding any other provision of law, if any entity of the government of Guam or any entity expending governmental funds intends to procure any supply or service which is offered by a business concern that is at least fifty-one percent (51%) owned by women, that entity shall procure such supply or service from that business concern if the supply or service is available within the period required by the procuring entity and the price for the supply or service does not exceed one hundred five percent (105%) of the lowest price bidder, and shall be in addition to any other procurement benefit the women-owned business may qualify for under Guam law. The procuring entity shall determine the lowest price to the entity in the case of more than one (1) women-owned business, or a women-owned business and a service-disabled veteran owned business, who are competing for the same government contract. (b) Qualifications of a Women-Owned Business. A business concern is qualified under Subsection (a) of this Section if: (1) the business concern is licensed to do business on Guam; (2) the business concern maintains its headquarters on Guam; (3) the business

concern is at least fifty-one percent (51%) owned by women, who manage day-to-day operations and make long-term decisions; (4) the business concern is certified as a Women Owned Small Business (WOSB) or an Economically Disadvantaged Women-Owned Small Business (EDWOSB) by the U.S. Small Business Administration; and (5) the owner(s) of the business concern has (have) filed individual tax returns on Guam for a period of at least three (3) consecutive years.

ORIGINAL

ITEM NO.	DESCRIPTION	QUANTITY	UNIT	UNIT PRICE	EXTENSION
1.1	Telescopic Boom Lift, 180' Reach Full time 4WD	1	EA.	\$ 659,193.27	\$ 659,193.27

**GENERALS:** These specifications have been written, to describe minimum equipment and performance requirements to be supplied by the equipment manufacture bidding. Reasonable test may be conducted upon delivery before acceptance.

The successful bidder shall furnish all necessary and desirable information and instructions for the proper operation of the equipment.

The government reserves the right to accept and/or reject any and all bids, to waive any defects, Irregularities, or specification discrepancies and to award the bid as council deems to be in the best interest of the government.

**DISCREPANCIES**

**LISTED:** Should any bidder have deviations from these specifications in his bid and cannot meet every requirement of the specifications, he shall submit a letter and attach it to the bid, explaining the deviations, failure to do so will cause the bid to be rejected as being non-responsive.

**DELIVER:** The successful bidder shall deliver one (1) 180' Boom Lift each be new fully assembled and ready for operation to the Port Authority of Guam within 120 days.

**SPECIFICATIONS:**

**BIDDING AND OR REMARKS:**

<b>Engine:</b> 74 hp minimum, Diesel Engine Engine shutoff protection system (Low Oil Pressure, High Engine Temperature High Transmission Temperature)	Comply _____
<b>Fuel Type:</b> Diesel (Ultra Low Sulfur) Tier IV	Comply _____
<b>Fuel Tank:</b> The fuel tank furnished shall be Min. 50 gallon	Please see attached letter of deviation -----
<b>Platform reach:</b> 180ft & 10ft jib	Comply _____
<b>Platform Dimensions:</b> 36 x 96 with railing & side entry	Comply -----
<b>Platform Capacity:</b> Unrestricted - 500 lbs	Comply _____
Restricted - 750 lbs	Comply _____
<b>Platform Rotation:</b> 160 degrees	Comply _____
<b>Swing:</b> 360 degrees continuous	Comply _____
<b>Steering:</b> Selectable Steering (ground level or platform)	Comply _____
<b>Axles:</b> Extendable front and rear	Comply -----
<b>Gauges:</b> Air, Fuel, Hour, Volt, Temp, and Oil	Comply _____
<b>Lights:</b> 2 Headlights in facing forward with protective guard, 2 Headlights facing rear with protective guard. 2 work lights on platform	Comply _____
<b>Tires:</b> Protector Lug Foam Filled tires	Comply _____
<b>Manlift Accessories:</b> Platform to be plumbed with air lines for use of pneumatic Tools	Comply _____
Hostile Weather/Environment Kit	Comply _____
AC plug/outlet in platform	Comply _____

ORIGINAL

<b>Accessories:</b>	Standard manufacture accessories' to include	<u>Comply</u>
	Horn - Electric	<u>Comply</u>
	Amber strobe light, key switch "on position" activated.	<u>Comply</u>
	Mounted 5 lbs. fire extinguisher on platform	<u>Comply</u>
	1 set "Shop Type" repair manuals and complete illustrated parts manual.	<u>Comply</u>
	Diagnostic and Troubleshooting software	<u>Comply</u>
	Owner/Operator manual for each equipment	<u>Comply</u>
	Maintenance and Service manual for each equipment	<u>Comply</u>
	Warranty booklet for each equipment	<u>Comply</u>
	Recommended spare parts list	<u>Comply</u>
	All fluids to the fullest level	<u>Comply</u>
	Fuel tank to be loaded with 10 gallons of diesel.	<u>Comply</u>
	Electronic Backup alarm	<u>Comply</u>
	Engine shut-off protection system (Low Oil Pressure, High Engine Temperature and High Transmission Temperatures),	<u>Comply</u>
	Reflective Conspicuity Tape	<u>Comply</u>
	Electronic rust prevention system	<u>Comply</u>

**Receiving Date:** (Acceptance Date) will be Three (3) days after delivery Date, provided the Equipment is Delivered Completely Assembled and meets all specifications, terms and conditions of the bid requirements. Comply

**Special Provision:** If parts catalog and maintenance repair comes in CD-ROM or Microfiche, bidder must supply to requesting agency. Bidder must still provide hard (book) copy to the requesting agency. Comply

**Applicable Federal Laws And Regulations:** Buy American Act – 41 U.S.C § 8301-8305  
Build America Buy America Act Certificate must be provide by the manufacture. Comply

**Training:** Provide 2 sessions on pre inspection, post inspection and safe operational procedures for all operators, leaders, supervisors and dispatchers within Maintenance division. Comply

**Warranty:** Manufacturers Standard Warranty, 1 year limited warranty. Service of one (1) year/ 2,000 hours, all parts, labor and oil disposal shall be included at "No Cost to the Government".

Yes, offer as requested. Comply

No, Offer the following: \_\_\_\_\_

The manufacturer Warranty and Boucher shall be specified on items covered and provided in the bid packet. (Bid submission received without written warranty and Boucher as specified will be rejected).

Yes, offer as requested. Comply

No, Offer the following: \_\_\_\_\_

ORIGINAL

The successful bidder shall provide technical assistance and warranty administration without any cost to "The Port Authority of Guam"

Yes, offer as requested. Comply

No, Offer the following: \_\_\_\_\_

The successful bidder shall provide service, such as to determine deficiency, repair or adjustment of the equipment on government premises or transfer the equipment to the shop where the repair should be done, at anytime within the warranty period and at "No cost to the Government". When the equipment is down for warranty repair(s) and remain in shop for a certain period awaiting part(s) and or material(s), the total down-time period shall be extended to the service and warranty period.

Yes, offer as requested. Comply

No, Offer the following: \_\_\_\_\_

The manufacture shall have a local authorized dealer who can provide factory trained service technician(s). Bidder shall provide certification of factory trained technician(s) for the above equipments be purchased during commissioning. Failure to provided will result as "Unacceptable".

Yes, offer as requested. Comply

No, Offer the following: \_\_\_\_\_

Provide Complete Familiarization Training to Port Representatives on maintenance of Mechanical, Electrical and Hydraulic systems on units by manufacturer. All costs Associated with training (airfare, lodging and transportation) are to be included At no cost to the Government of Guam.

Yes, offer as requested. Comply; training will be conducted on Guam by Morrigo Equipment factory trained technician.

No, Offer the following: \_\_\_\_\_

ORIGINAL

This project is funded under the Fiscal Year 2022 America's Marine Highway (AMH) Program Grant No.: 693JF72340007

X Certification requirements for procurement of steel, iron, construction materials, or manufactured products.

If steel, iron, construction materials, or manufactured products (as defined in § 70914(a) of the Build America, Buy America Act, Pub. L. No. 117-58, div. G, tit. IX, subtit. A, 135 Stat. 429, 1298 (2021) and Office of Management and Budget (OMB) Memorandum M-22-11, "Initial Implementation Guidance on Application of Buy America Preference in Federal Financial Assistance Programs for Infrastructure," as implemented by MARAD through Term B.5 of the exhibits to the agreement) are being procured, the same or equivalent certificate as set forth below shall be completed and submitted by each bidder or offeror in accordance with the requirement contained in section 2.1 of the agreement.

**Certificate of Compliance with Buy America Requirements**

The bidder or offeror hereby certifies that it will comply with the requirements of § 70914(a) of the Build America, Buy America Act, Pub. L. No. 117-58, div. G, tit. IX, subtit. A, 135 Stat. 429, 1298 (2021), as implemented by MARAD in Term B.5 of the exhibits to the grant agreement.

Date Feb 15, 2024  
Signature [Handwritten Signature]  
Company Morrice Equipment LLC  
Name Jesse Munoz  
Title Heavy Equipment Sales Manager

**Certificate of Non-Compliance with Buy America Requirements**

The bidder or offeror hereby certifies that it cannot comply with the requirements of § 70914(a) of the Build America, Buy America Act, Pub. L. No. 117-58, div. G, tit. IX, subtit. A, 135 Stat. 429, as implemented by MARAD in Term B.5 of the exhibits to the grant agreement, but it may qualify for an exception to the requirement pursuant to § 70914(b) of the Build America, Buy America Act and Term B.5.

Date Not applicable  
Signature Not applicable  
Company Not applicable  
Name Not applicable  
Title Not applicable

**Notes:** Bidder shall identify on their bids, any deviations from the specifications or requirements in the remarks column and state the item being offered for evaluation processing. Failure to comply may result in the rejection of the bid.

A certificate of origin is required on the sale of equipment.

Equipment must be delivered to the Port Authority of Guam for inspection

**Bidding on:** Telescopic Boom Lift 180' reach, Full time 4WD

MANUFACTURER: JLG  
MAKE: JLG  
MODEL: 1850SJ  
YEAR: 2024  
PLACE OF ORIGIN: USA  
DATE OF DELIVERY: As per bid, 460 days ARO

These specifications have been developed by Port Authority of Guam's, Raymond B. Santos- Transportation Superintendent, Joaquin P. Pangelinan- Equipment Service Support Manager, reviewed by Glenn B. Nelson- Operations Manager, Dominic G. Muna- DGMO, Pacifico Martir- DGMA, and approved by Rory J. Respicio- General Manager

ORIGINAL

# 1850SJ

TELESCOPIC ULTRA BOOM

BOOM LIFT



## KEY SPECS

<b>Platform Height</b> 185-ft 7-in / 56.56-m	<b>Horizontal Outreach</b> 80-ft / 24.38-m
<b>Drive Speed</b> 2.8 mph / 4.5 km/h	<b>Platform Capacity</b> 1,000-lb / 454-kg - Restricted 500-lb / 227-kg - Unrestricted

## KEY FEATURES

- Expansive work area of a maximum platform height of 185-ft and a telescoping jib that provides 2.9 million cubic feet of work area.
- Enhanced Platform Controls - An LCD screen shows operators where they are in the work envelope, along with other useful information.
- Optimized maneuverability with full-time four-wheel drive to traverse over rough terrain.
- Single sensor load sensing system features fewer parts and requires no weight to calibrate.

## ACCESSORIES & OPTIONS

- Accessory Packages:
  - SkyWelder® Package
  - SkyPower® Package
  - SkyGlaizer® Package
- Ambient White Noise Alarm
- Bolt On Fall Arrest System
- Cold Package Plus<sup>1</sup>
- Cold Weather Package<sup>2</sup>
- Hostile Environment Package<sup>3</sup>
- Light Package
- Platform Mesh, Bolt On
  - Mesh to Top Rail, Plastic or Aluminum
  - Mesh to Mid Rail, Plastic or Aluminum
- Platform Options
  - Fall Arrest, Rear Entry - 36 x 96-in
  - Drop Bar - 30 x 36-in, 36 x 96-in
  - Inward Self-Closing Swing Gate - 36 x 72-in, 36 x 96-in
  - Tri-Entry, Drop Bar - 36 x 72-in, 36 x 96-in
  - Tri-Entry, Swing Gate - 36 x 72-in, 36 x 96-in
- SkySense® Enhanced Detection System
- Soft Touch System
- Storage Tray, Center or Corner

## STANDARD SPECIFICATIONS

### Performance

<b>Platform Height</b>	<b>185-ft 7-in / 56.56-m</b>
Horizontal Outreach	80-ft / 24.38-m
<b>Swing</b>	<b>360 Degrees Continuous</b>
<b>Platform Capacity (Restricted)</b>	<b>1,000-lb / 454-kg</b>
<b>Platform Capacity (Unrestricted)</b>	<b>500-lb / 227-kg</b>
<b>Platform Rotator</b>	<b>173 Degrees Hydraulic</b>
<b>Jib Length (Retracted/Extended)</b>	<b>13-ft (3.96-m) / 20-ft (6.1-m)</b>
Jib Range of Articulation	120 Degrees (+75, -45)
Weight*	59,900-lb / 27,170-kg
Max. Ground Bearing Pressure	119.6 psi / 8.41 kg/cm <sup>2</sup>
Drive Speed	2.8 mph / 4.5 km/h
Gradeability	40%
Tilt Cut Out	5 Degrees
<b>Turning Radius (Inside):</b>	
<b>Axles Retracted/Extended</b>	<b>23-ft 4-in (7.12-m) / 7-ft 7-in (2.3-m)</b>
<b>Turning Radius (Outside):</b>	
<b>Axles Retracted/Extended</b>	<b>31-ft 3-in (9.52-m) / 21-ft 8-in (6.6-m)</b>

### Engine

<b>Diesel Engine - Deutz TCD 3.6L Tier IV F</b>	<b>99.8 hp / 74.4 kW</b>
<b>Fuel Tank Capacity</b>	<b>45 gal / 170 L</b>

### Tires

<b>Standard</b>	<b>445/50D710 Foam-filled</b>
-----------------	-------------------------------

### Hydraulic System

Capacity	75.1 gal / 284.2 L
----------	--------------------

## STANDARD FEATURES

- 12V-DC Auxiliary Power
- 173 Degrees Hydraulic Platform Rotator
- 3 Selectable Steering Modes
- AC Receptacle in Platform
- All Motion Alarm
- ClearSky Smart Fleet™ Hardware (CS550)\*\*
- Control ADE® System
- Drive-Out Extendable Axles
- Engine Distress Warning/Shutdown—Selectable via JLG Analyzer
- Full-Time 4WD
- Glow Plugs
- Gull-Wing Steel Hoods
- Hourmeter
- LED Motion/Amber Beacon (CS550)\*\*
- Lifting/Tie Down Lugs
- Load Sensing System
- LCD Panel at Operator's Platform Control Console
- Platform 36 x 96-in (.91 x 2.44-m) Side Entry
- Proportional Controls
- Platform Console Machine Status Light Panel\*\*\*
- Selectable Capacity Envelope
- Swing-Out Engine Tray
- SkyGuard SkyLine™
- Tilt Light and Alarm

\*Certain Options or Country Standards Increase Weight

\*\*Standard Beacon and ClearSky Smart Fleet Hardware Availability Varies by Model Throughout 2025

\*\*\*Provides Indicator Lights at Platform Control Console for System Distress, Low Fuel, Degree Tilt Light and Load Weight Status.

1. Includes extreme cold engine oil, fuel conditioner, engine block heater, battery blanket, glow plugs, hydraulic tank heater, and oversized footswitch.

2. Includes battery blanket, hydraulic tank heater, block heater.

3. Includes console cover, boom wipers and cylinder bellows.

Additional accessories and options available via JLG Aftermarket.

Shown with Optional Mesh to Top Rail

ORIGINAL



# 1850SJ

TELESCOPIC ULTRA BOOM

BOOM LIFT



## DIMENSIONS

## REACH DIAGRAM

All dimensions are approximate

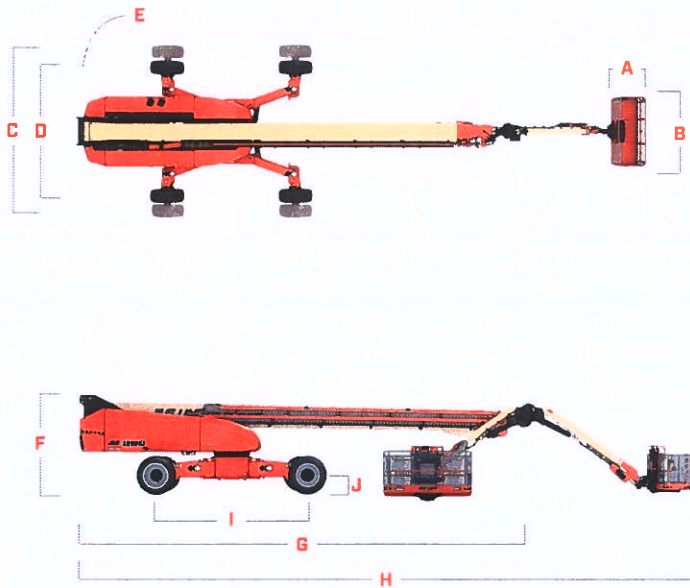

A. Platform Width	36-in / 91-cm
B. Platform Length	96-in / 2.44-m
C. Machine Width - Axles Extended	16-ft 6-in / 5-m
D. Machine Width - Axles Retracted	8-ft 2-in / 2.49-m
E. Tailswing	7-ft 7-in / 2.32-m
F. Machine Height	10-ft / 3.05-m
G. Machine Length - Stowed	47-ft 9.5-in / 14.57-m
H. Machine Length - Overall	63-ft 10-in / 19.45-m
I. Wheelbase	17-ft 1.5-in / 5.22-m
J. Ground Clearance	13.5-in / 34-cm - Axle 16.25-in / 41-cm - Chassis

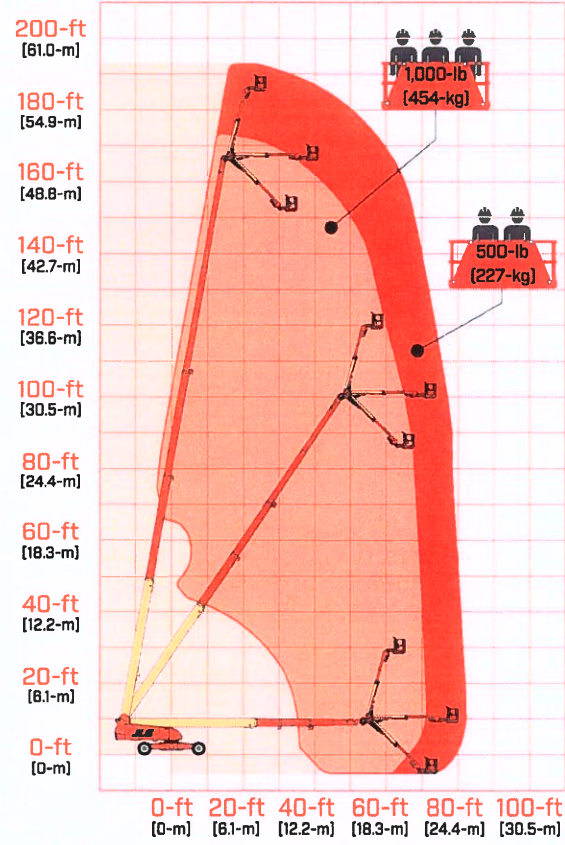

Sales, Rental, Parts and Service  
 197 Ypao Road Tamuning, Guam 96913  
 Tel: 649-1946 Fax: 649-1947  
 Website: [www.morricequipment.com](http://www.morricequipment.com)



We provide coverage for one (1) full year, and cover all specified major structural components for five (5) years. Due to continuous product improvements, we reserve the right to make specification and/or equipment changes without prior notification. This machine meets or exceeds applicable ANSI and CSA requirements based on machine configuration as originally manufactured for intended applications. Please reference the serial number plate on the machine for additional information.



JLG INDUSTRIES, INC.  
 Toll-free US 877-JLG-LIFT  
 JLG.com  
 An Oshkosh Corporation Company



# WARRANTY POLICIES AND GUIDELINES

North America  
January 2023



**JLG**  
ORIGINAL

### JLG NEW PRODUCT WARRANTY AMERICAS

JLG Industries, Inc. ("JLG") warrants its new products made by it to be free from defects in material or workmanship for twelve (12) months from the warranty start date.

In addition, JLG further warrants the structural elements of each new Boom Lift, Scissor Lift, Vertical Mast, Telehandler, Power Tower, Trailer, and Trailer Boom (JLG LiftPod product excluded) made by it, as defined in its then current warranty policies and procedures, to be free from defects in material or workmanship for five (5) years from the warranty start date.

JLG further warrants the powertrain of each of the new telescopic handlers made by it, as defined in its then current warranty policies and procedures, to be free from defects in material and workmanship for twenty-four (24) months or 2,000 hours, whichever occurs first.

JLG agrees only to repair or replaced at its own expense, F.O.B. (E.X.W.), the place or places of manufacture, any part or parts of the product found to be defective in material or workmanship, provided JLG is notified of such defect or defects within the applicable warranty period and given a reasonable time to correct the defect. In no case shall any warranty extend to defects in materials, components, or services furnished by third parties. Defects caused by chemical action or the presence of abrasive materials and defects arising following the operation beyond rated capacity or the improper use or application of any products shall not be considered defects within the scope of this warranty. If any repairs or alterations are made or any parts are replaced during the applicable warranty periods by anyone other than JLG or an entity authorized by JLG in accordance with authorized JLG service manuals or with parts, accessories, or attachments other than authorized by JLG for use in its products, customer shall pay for such repairs or parts without recourse against JLG, and JLG shall be relieved of responsibility for fulfillment of this warranty with respect to such repairs, alterations, or replacements so made. JLG's obligations under this warranty shall at all times be subject to its then current warranty policies and procedures. The above-mentioned warranty shall not apply to replacement or service parts made and sold to a customer by JLG. Routine maintenance, routine maintenance items (including paint and decals), and minor adjustments are excluded from this warranty. Certain components, including, but not limited to, engines, tires, and batteries, which may be a part of the product are not manufactured or warranted by JLG. Any applicable warranty for such components is provided through the original manufacturer of the component or its distributor organization.

JLG further warrants that each unit is designed, built, and equipped to meet United States Environmental Protection Agency ("EPA") and, where applicable, California Air Resources Board ("CARB") emissions requirements in effect on the date of manufacture. JLG further warrants that the unit is free from defects in material and workmanship that might prevent the unit from meeting applicable EPA and CARB requirements. Policy holders may obtain such emissions warranty service at no cost, including parts, labor, and diagnostic services, for their equipment from an authorized JLG Servicer or any authorized servicer of the Engine OEM. Please also note that this Emissions Control System Warranty is required by EPA, and in certain equipment applications, by CARB, and is a distinct and additional warranty from the general commercial warranty described herein that JLG and its engine suppliers provide to customers who purchase JLG equipment and associated engines. Please refer to the "JLG Emissions Warranty Guidelines," available for download at [www.JLG.com](http://www.JLG.com), for additional details specific to your machine. End users may also perform their own repairs of emissions-related components, although the cost of labor and diagnostic services provided by other than an authorized JLG servicer or OEM are outside the scope of this warranty and will not be paid for by JLG free of charge. The proper performance of routine maintenance by the customer or a third-party service shall not invalidate this emissions warranty.

### JLG NEW PRODUCT WARRANTY NORTH AMERICA

JLG Warranty Policy covers Parts, Labor, and Travel costs as outlined in JLG's then current warranty policies and procedures. JLG LiftPod Product is excluded from Travel coverage.

JLG Warranty Policy does not cover any duties, taxes, environmental fees, including without limitation, disposal or handling of tires, batteries, and petrochemical items.

Under no circumstances shall JLG be liable for any consequential or special damages which any person or entity may incur or claim to incur as a result of any defect in the product or in any correction or alteration thereof made or furnished by JLG or others. "Consequential" or "special damage" includes, but is not limited to costs of transportation, lost sales, lost orders, lost profits, lost income, increased overhead, labor and material costs, and cost of manufacturing variances and operational inefficiencies. JLG's maximum liability under this warranty shall be the purchase price paid to JLG with respect to the product to which such warranty is claimed. The limitation of liability provisions herein shall apply to any and all claims or suits brought against JLG, including any claim based upon negligence, breach of contract, breach of warranty, strict liability or any other theories upon which liability may be asserted against JLG.

This warranty constitutes JLG's entire and exclusive warranty as to the product and is the sole and exclusive remedy for product defects in material and workmanship. JLG does not assume (and has not authorized any other person to assume on its behalf) any other warranty or liability in connection with any product covered by this warranty. **JLG EXPRESSLY DISCLAIMS ANY AND ALL OTHER WARRANTIES OF ANY KIND WHATSOEVER AS TO THE PRODUCT FURNISHED HEREUNDER, INCLUDING BUT NOT LIMITED TO ANY EXPRESS WARRANTIES, EXCEPT FOR THE EXCLUSIVE WARRANTY PROVIDED HEREIN, OR IMPLIED WARRANTIES AS TO MERCHANTABILITY, OR FITNESS FOR ANY PARTICULAR PURPOSE.**

This warranty shall be void, if, upon the occurrence of any incident involving any product made by JLG and resulting in any personal injury or property damage, customer shall fail to notify JLG within 48 hours of such occurrence or permit JLG and its representatives to have immediate access to such product and all records of or within the control of customer relating to the product and occurrence.

3128772\_Americas\_English\_2022

ORIGINAL



# GENERAL WARRANTY COVERAGE

## WARRANTY OVERVIEW

JLG's warranty provides owner protection for product and part defects in material and workmanship during a specified period of time or product usage. The warranty also protects JLG and its Account Holders from unreasonable claims.

The commitments and limitations outlined in JLG's Warranty Statement are not subject to change or alteration. JLG's Warranty Statement is provided to JLG Account Holders and is included in Section A of this manual.

In response to valid warranty claims, JLG has the option of furnishing replacement part(s), crediting cost of part(s), or paying reasonable costs to repair any defective part(s).

JLG's product warranties are country or region specific and may be different from country to country. The warranty that applies is dependent on the country or region where the product is originally manufactured or sold.

## WARRANTY STATEMENT DISCLAIMER

The Warranty Statement contains a disclaimer that you should read carefully and note. Two important points in the JLG Warranty Disclaimer are: 1) no other warranty or promise can be implied except for what is expressly stated; and 2) any incidental and consequential damages experienced in connection with the use of a machine or product are specifically excluded.

## WARRANTY REGISTRATION

Warranty Registration Forms MUST be completed and received within six (6) months of the ship date for machines purchased with a Standard Warranty, and within two (2) months of the ship date for machines purchased with an Extended Warranty. Warranty Registration Forms are included with the packet of materials shipped with each machine and can also be found on Online Express. Completed forms can be mailed via U.S. Mail, postage prepaid to JLG Industries, Attn: Warranty Department; faxed to 717-485-6032; or e-mailed to [JLGWarranty@jlg.com](mailto:JLGWarranty@jlg.com). Warranty registrations can be submitted online through Online Express as well.

If the Warranty Registration Form is not timely received, the machine ship date of the unit will be used as the Warranty Start Date.

## WARRANTY COVERAGE

JLG processes warranty claims globally for:

- Standard Warranty
- Parts Warranty
- Structural Warranty
- Extended Warranty
- Reconditioned Warranty
- Service Campaign
- Safety Campaign

## WARRANTY COVERAGE Continued

The warranty tab selection located on Online Express will direct you to the warranty module, which allows you to enter and inquire about warranty claims, return parts, and create and print reports. Paper submittal of claims is also available, although a service fee may be applied for any claim not submitted online. Warranty claims cannot be completed or processed over the phone.

Claim submittal and processing is performed through an Electronic Warranty System: <http://onlineexpress2.jlg.com> or [www.servicebench.com](http://www.servicebench.com).

## STANDARD WARRANTY

JLG's Standard Warranty provides the following coverage for defects in material and workmanship in JLG products:

- AWP – 12 months parts, labor, and travel
- Trailers – 12 months parts, labor, and travel
- Telehandlers – 12 months parts, labor, and travel
- LiftPod – 12 months parts and labor only on each component that makes up the LiftPod: platform, mast, and base.

In administering the warranty policy for valid claims, JLG reserves the right to furnish replacement part(s), credit the cost of the part(s) based on the net price paid by the Account Holder or pay reasonable cost to repair the defective part(s). If a repair is made by an outside dealer, an invoice is required at the time of submission of the claim. Parts and components requested to be returned to JLG in connection with a warranty claim shall be returned to a location designated by JLG. Any and all such components and parts shall become property of JLG.

Labor reimbursement will be in accordance with JLG's current warranty Labor Guidelines and with credit based on percentage assigned according to the Sales & Service Agreement.

Travel time will be reimbursed based on the percentage assigned according to the Sales & Service Agreement. The maximum travel allowance permitted for reimbursement is three (3) hours per eligible repair. Repairs completed at the Account Holder's repair facility are not eligible for travel reimbursement. Account holders must maintain valid work orders containing the travel time being requested. Travel reimbursement is not available for LiftPod warranty claims.

## POWERTRAIN WARRANTY

Powertrain Warranty applies only for JLG telehandler products and provides coverage for defects in material and workmanship for 24 months or 2,000 hours, whichever occurs first, from the Warranty Start Date. Powertrain Warranty covers the following components: Axle Housing, Drive Hub, Differential, Drive and Axle Shaft, Piston Pump, Power shift Transmission/Torque Converter and Drive Motor, and other components that are supplied as part of a Transmission Assembly. You must contact your JLG Representative prior to any powertrain repairs to verify warranty coverage and proper repair procedures.

*[Handwritten signature]*



## GENERAL WARRANTY COVERAGE Continued

### STRUCTURAL WARRANTY

All new JLG Products have a Structural Warranty covering the structural weldments of the unit for a sixty (60) month period from the Warranty Start Date. Structural components include

- Platform Support Weldments
- Boom Section Weldments
- Frame Weldments
- Extendable Axle Weldments
- Outrigger Weldments
- Scissor Arm Weldments
- Scissor Platform Deck Weldments
- Rear Axle Weldments
- Transfer Carriage
- Vertical Production Mast Section

Warranty reimbursement during the Structural Warranty period will be made for the replacement or repair of the defective component to the Account Holder. Your JLG Representative must be contacted for the proper repair procedures prior to any structural repairs. Labor and travel reimbursement will be compensated as described in the Standard Warranty Policy shown above. All structural claims estimated at \$5,000.00 and above will require either a return of defective part(s) or pictures of the defective part(s) at JLG's discretion.

### NEW PARTS WARRANTY

New Parts Warranty provides coverage for a replacement part that was installed on a unit and failed within six (6) months of installation. Labor and inbound shipping reimbursement is not available in connection with Parts Warranty claims.

We may require that parts and components be returned for diagnosis. If so, please refer to the Warranty Return Parts section for proper return information. All returned components and parts shall become property of JLG.

It is recommended that only genuine JLG replacement parts be used for any repairs on JLG units. This will ensure the parts meet JLG engineering design and quality control standards.

### RECONDITIONED PARTS WARRANTY

JLG's Reconditioned Parts Warranty provides coverage for reconditioned part(s) for defects in material and workmanship for a twelve (12) month period from the date of part installation. All reconditioned/remanufactured parts contain an EX at the end of the part number. All

Reconditioned Warranty Parts claims can be filed through JLG's Electronic Warranty System.

### USED MACHINE WARRANTIES

JLG currently offers several types of used warranty programs which involve a basic inspection of the unit as identified below:

- RECONDITIONED MACHINE WARRANTY – machines go through a comprehensive re-haul and are warrantied for three years/ 3,000 hours from purchase date.
- CERTIFIED MACHINE WARRANTY – machines go through an elevated inspection and are warrantied for two years/2,500 hours from purchase date

\*\*\*All used machine claims \$5000.00 or more require photos and pre-approval.

### EXTENDED WARRANTY

Extended Warranty coverage is based on the terms defined at the time of purchasing the unit. JLG's Extended Warranty Manual provides more details on Extended Warranty coverage.

### SERVICE CAMPAIGNS

Service Campaigns are notifications of product enhancements or improvements to specific models or product lines. In some circumstances, reimbursement for parts or labor may be allowed. Reimbursement and time for completion vary from campaign to campaign. Warranty Reimbursement will be honored in accordance with the release if completed within the specific time allotted for completion.

### SAFETY CAMPAIGNS

JLG may issue Safety Campaigns (letter campaigns, field memos, or letters) to address safety-related issues on certain units manufactured by JLG. JLG policy strictly follows the guidelines set forth by the safety campaign.

Reimbursement and time for completion vary from campaign to campaign and are honored in accordance with the release of the safety campaign.

Safety Campaigns must be completed in the time period as provided in the campaign.



## NON-WARRANTY

### MAINTENANCE & PDI'S

Routine maintenance, maintenance items (such as lubrication, filters, wear pads, crawler tracks, switches, and buttons), and pre-delivery inspections are not covered under the warranty policy. Pre-delivery inspections are conducted to verify the unit is operating properly prior to delivery to the account holder's customer.

Minor adjustments – such as loose fittings, loose hardware (bolts, nuts, screws), loose connections, recalibrations, and machine settings – are only covered under warranty when detected and repaired during initial machine delivery or 30 days after initial delivery from JLG.

### ENGINES, TIRES, AND NON-LITHIUM BATTERIES

The following components are excluded from JLG warranty: engines (except for GM engine), tires, and non-lithium batteries. We advise all Account Holders to contact the OEM suppliers directly for warranty repair consideration and coverage.

---

For lithium battery and GM engine installations contact JLG for warranty claims

---

The Account Holder is responsible for following any applicable OEM policies and procedures in administering warranty claims. Warranty consideration will be determined and honored by each OEM supplier.

---

Always refer to each respective OEM's Warranty Policies and Procedures for specific information and guidelines in Section G of this manual.

---

In the event you do not receive adequate response or assistance from an OEM, or for a current list of the excluded components, contact the JLG Warranty Team at 1-877-554-5438.

When filing warranty claims for engines, generators, and welders, ensure that the following information is readily available for the applicable OEM:

- Local Account Holder's Name and Contact Person
- Local Account Holder's Phone Number
- S/N of Component
- S/N of JLG Product
- Hours of Use
- A description of the Complaint/Failure

### DIAGNOSTIC & TROUBLESHOOTING TIME

Warranty Reimbursement covers defects in material and workmanship. Determining the problem or failure on the unit through diagnostic and troubleshooting time is not eligible for reimbursement. Analyzers are available along with troubleshooting guides, and training seminars to assist in performing diagnostics and troubleshooting failures. All fault code guides (model specific) along with the Service & Parts Manuals are also accessible through Online Express to assist in troubleshooting.

---

Online Express: <http://onlineexpress2.jlg.com>

---

### NORMAL WEAR, NORMAL MAINTENANCE, IMPROPER HANDLING, ENVIRONMENTAL CONDITIONS

JLG's warranty policy does NOT cover:

- Any failures caused by abuse, use in improper application, or use above rated capacity (e.g., hour meter/tachograph/odometer that has been tampered with, altered, or disconnected).
- Exposure to chemical, electrical, or radioactive elements or situations.
- Improper installation, use, fuels, lubricants, operation, maintenance, transportation, or packing.
- Improper preservation of unit due to exposure to abusive environmental conditions.
- Liability for bodily injury or property damage caused directly or indirectly by a machine failure or malfunction.
- Loss or damage caused by theft or any attempted theft.
- Loss or damage caused by events, such as war, invasion, acts of foreign enemies, acts of terrorism, hostilities, or warlike operations.
- Loss or damage resulting from external causes, such as, but not limited to, collision(s) with any object, dirt, earthquake, fire, flooding, hail, sand, windstorm, an Act of God, or exposure to weather conditions.
- Normal maintenance, service or the replacement or repair of parts required in the course of normal maintenance service.
- Normal wear and tear, contaminants exposure, corrosion, or prolonged or improper storage (i.e., paint and decal damage).
- Premium charges for overtime and shift labor.
- Repairs completed by Non-Account Holders.

ORIGINAL





## NON-WARRANTY Continued

### Other Excluded Items

In addition to diagnostic, maintenance, inspections and troubleshooting, the following items are also excluded from JLG Warranty Policy:

- Conducting of all inspections and daily walk-around inspections.
- Consequential, incidental, or special damages.
- Duties, shop supplies, taxes, environmental fees, and disposal and handling fees.
- Emergency order change(s).
- Equipment transport and part freight cost(s).
- Minor adjustments and modifications.
- Attachments and Carriages purchased after the initial sale of the machine.
- Oil/hydraulic fluids (machine fluids).
- Recalibrations/machine settings, personality settings.

### VOIDING WARRANTY

While JLG cannot void or cancel its product warranty, it can elect to not provide warranty coverage for a failure that was caused by misuse or modification (i.e., altered, added to, misadjusted), deemed not a result of a defect in factory material or workmanship, or if invalid or untrue information is submitted on a claim.

---

Customers must contact JLG's Product Safety and Reliability Department before making any modifications, alterations, or added adjustments to machines.

Email: [productsafety@jlg.com](mailto:productsafety@jlg.com)  
Call: 1-877-JLG-SAFE.

---

Account Holders can complete a Product Modification and Application Request form online through Online Express.

There may be times when circumstances dictate issuing credit for an apparent warranted repair before a complete or thorough analysis of the failed part can be performed. If, upon return of the requested part(s) to JLG and completion of the analysis, the parts do not prove to be defective, the repair will not be covered under warranty and a debit invoice will be issued for the previously allowed credit against the submitted claim.





# INSPECTIONS

## DELIVERY INSPECTIONS

The carrier is responsible for any damage that has occurred on the machine during transit.

Upon delivery of a new product to a facility, a visual walk around inspection should be completed before accepting the unit from the carrier. If any damage is found, the carrier MUST be advised via the bill of lading.

Under NO CIRCUMSTANCES should the Account Holder sign the Bill of Lading or CMR without noting the damage on the form.

If the Bill of Lading or CMR is signed without designating the damages, the carrier has the right to deny repair reimbursement, and JLG reserves the right to deny any related warranty claims. Freight damage is the responsibility of the carrier.

## COUNTRY REQUIRED INSPECTIONS

Machine inspections vary from country to country. The Account Holder has the responsibility to verify the countries requirements on certifications and inspections and complete the inspections as required.



## NEW MACHINE INSPECTIONS (NMI)

New Machine Inspections (NMI) is required upon arrival of the unit at the Account Holder's location and used to monitor the quality of the unit upon arrival. All discrepancies should be noted on the form, detailing the location and type of discrepancy. The NMI is in the manual packet supplied with each unit.

You may request additional forms by contacting the JLG Warranty Department at 1-877-JLG-LIFT.

OR

NMI forms are available on Online Express:

<http://onlineexpress2.jlg.com>

### NMI FORM PART NUMBERS

Scissor	3124178
Boom	3124178
Vertical Mast	3124177
Telehandler	3124290
Trailer	3124178
LiftPod	3126620

**\*Submittal of a New Machine Inspection form does not start the warranty on a unit\***

## ANNUAL MACHINE INSPECTIONS (ANSI)

The American National Standards Institute (ANSI) requires that the owner of an aerial work platform perform an inspection of each unit owned on an annual basis. Although JLG does not require Annual Machine Inspection forms to be submitted to JLG, it does provide forms for Account Holders.

Forms are available through JLG Parts Department  
OR

ANSI forms are available on the JLG website:

<http://www.JLG.com> under the Service and Parts tab.

### ANSI FORM PART NUMBERS

Boom Lift, Trailer, Trailer Mounted Boom Lift	3124166
Scissor	3124167
Vertical Products, VP, VPSP, DVL, DVSP, SSV, MSP	3124169
TF6-42, Material Handler	3124107
LiftPod	3126620







# DEUTZ Limited Warranty Statement

DEUTZ ENGINE, DEUTZ XCHANGE® ENGINE,  
GENUINE DEUTZ PART OR GENUINE DEUTZ XCHANGE® PART

1. DEUTZ Corporation (“DC”) warrants that each new DEUTZ engine or genuine DEUTZ XCHANGE® Engine (“Engine”) or genuine new DEUTZ spare or replacement part or DEUTZ XCHANGE® (“Part”) supplied by DC or an authorized distributor of DC, purchased by the customer and properly installed in an application, will be free from defects in material and workmanship under normal use and service. If, during the warranty period following the delivery of the Engine or Part, it is shown there is a defect in material or workmanship caused solely by failure of DC’s manufacturer (DEUTZ AG) to meet such standards, and customer has notified DC in writing of such defect within that period, DC shall repair or replace, at DC’s cost and option, such defective Engine or Part. Such repair or replacement will be made without charge to the customer at customer’s premises or, at the option of DC, at such other location as DC may designate. Any Engine or Part that is replaced shall become the property of DC. Any repaired or replaced Engine or Part shall be warranted until the expiration of the original warranty period. DC’s warranty obligation is expressly conditioned upon the customer fulfilling all obligations pursuant to customer’s purchase order, including, without limitation, all payment obligations.

2. ENGINES NEW and DEUTZ XCHANGE®  
Warranty coverage is provided for the DEUTZ engine series listed below:

Warranty Period	Operating Hours	Warranty Coverage
12 months	Unlimited	All components
24 months	1.2, 1.7 1000h 1011, 1011F, 2011 2000h 2.2, 2.9, 3.6 2000h 1012, 2012, 1013, 2013 3000h 912, 913, 914, 4.1, 6.1, 7.8 4500h 913 and 914 gas engines 4000h 413, 513, 1015, 2015, 2015 gas engine 5000h 9.0, 12.0, 13.5, 12.0 V, 16.0 V, 18.0 5000h	All components of the engine
36 months	1.2, 1.7 1500h 1011, 1011F, 2011 3000h 2.2, 2.9, 3.6 3000h 1012, 2012, 1013, 2013 4500h 912, 913, 914, 4.1, 6.1, 7.8 4500h 913 and 914 gas engines 4500h 413, 513, 1015, 2015, 2015 gas engine 7500h 9.0, 12.0, 13.5, 12.0 V, 16.0 V, 18.0 7500h	Main engine components, Crankcase, Crankshaft, Camshaft, Connecting Rods, Cylinder Head Casting

The Engine warranty will commence: At the date of sale to the original retail customer, OR One Year from the date of manufacture, Whichever Occurs First.

3. PARTS: Warranty coverage is provided for each Genuine DEUTZ Part or DEUTZ XCHANGE® Part for a period of 12 months from the date of sale to the original retail customer.

4. This warranty does not cover the following: (i) wear and tear or contaminants; (ii) exposure, corrosion or prolonged or improper storage; (iii) normal maintenance service or the replacement or repair of parts required to be replaced or repaired in the course of normal maintenance service; (iv) improper installation, use, fuels, lubricants, operation, maintenance, transportation or packing; (v) misuse, alteration, negligence and accidents; (vi) chemical or electrical action; and (vii) unauthorized repairs FDSFDA

5. This warranty does not cover any components manufactured by someone other than DC or DEUTZ AG, and DC makes no warranty whatsoever with respect to such components. Such components will be covered only by the warranties, if any, as may be issued by such suppliers themselves, which warranties will be made available to customer upon request. This warranty does not cover any components added by DC’s customers before reselling it to the end-customer, and DC makes no warranty whatsoever with respect to such components.

6. The warranties, obligations, liabilities and remedies of the parties, as provided herein, are exclusive and in lieu of any others available at law or in equity. DC’s total aggregate liability with respect to any defective Engine or Part shall not exceed the amount paid by the customer for such Engine or Part and customer agrees to release, defend, indemnify and hold DC harmless from and against any and all further liability in excess thereof arising in any manner from any alleged defective Engine or Part. To the fullest extent allowed by law, releases from, and limitations of liability shall apply notwithstanding breach of contract, tort (including negligence), strict liability or other theory of legal liability of the party released or whose liability is limited. The laws of the State of Georgia shall govern this warranty.

7. Under no circumstances will the customer be entitled to rescission or to a reduction in the purchase price. Customer waives any and all claim for loss of time, replacement power, increased cost, inconvenience, loss of use or profit, loss of goodwill, cost of capital, cost of rentals or any other direct, indirect, punitive, special, exemplary, incidental or consequential damages whatsoever.

8. This warranty and the DEUTZ emission warranties for EPA certified DEUTZ engines and genuine DEUTZ parts installed in such engines are in lieu of all other express or implied warranties of DC and DEUTZ AG with respect to DEUTZ engines and genuine DEUTZ parts, including, without limitation, any implied warranty of merchantability or fitness for any particular purpose. Neither DC nor DEUTZ AG assume, nor authorize any distributor or other person to assume, on their behalf, any other obligation or liability.

9. For details of the DEUTZ warranty contact:

DEUTZ Corporation  
Warranty Department  
3883 Steve Reynolds Blvd  
Norcross GA 30093 USA  
Phone: 770-564-7100  
[www.deutzusa.com](http://www.deutzusa.com)

ORIGINAL



## FEDERAL EMISSION CONTROL WARRANTY STATEMENT

This Federal Emission Control Warranty applies to the following engine power ranges manufactured on or after the Implementation date:

Engine Gross Horsepower	Implementation Date
> 750 hp	Jan 1, 2000
≥ 175 hp ≤ 750 hp	Jan 1, 1996
≥ 100 hp < 175 hp	Jan 1, 1997
≥ 50 hp < 100 hp	Jan 1, 1998
≥ 25 hp < 50 hp	Jan 1, 1999
> 0 hp < 25 hp	Jan 1, 2000

### Emissions Warranty

DEUTZ Corporation (DEUTZ) warrants to the initial owner and subsequent owner of a certified non-road diesel engine (powering non-road equipment), that such engine is:

1. Designed, built and equipped so as to conform, at time of sale, with all applicable regulations adopted by the United States Environmental Protection Agency (EPA).
2. Free from defects in materials and workmanship of specific emission-related components for the appropriate period of years or hours of operation (as specified in the following table) after date of delivery to the initial owner.

Engine Gross Horsepower	Engine Category	Warranty Period (Whichever occurs first)
> 0 hp < 25 hp	All engine types	2 years / 1500 hrs.
≥ 25 hp < 50 hp	Genset engines ≥ 3000 rpm's	2 years / 1500 hrs.
≥ 25 hp < 50 hp	All engine types except Genset engines ≥ 3000 rpm's	5 years / 3000 hrs.
≥ 50 hp	All engine types	5 years / 3000 hrs.

If an emission-related component fails during the warranty period, it will be repaired or replaced. Any such component repaired or replaced under warranty is warranted for the remainder of the warranty period.

During the term of this warranty DEUTZ will provide, through a DEUTZ distributor or other DEUTZ-authorized facility, repair or replacement of any warranted part at no charge to the non-road engine owner.

In an emergency, repairs may be performed at any facility, or by the owner, using any replacement part.

DEUTZ AG

DEUTZ Corporation

3883 Steve Reynolds Blvd. Norcross, GA 30093

Phone: 770-564-9886 Fax: 770-564-7222

E-mail: [service.support@DEUTZusa.com](mailto:service.support@DEUTZusa.com) [www.DEUTZamericas.com](http://www.DEUTZamericas.com)

ORIGINAL

The engine company.





DEUTZ will reimburse the owner for their expenses, including diagnostic charges for such emergency repair. These expenses shall not exceed DEUTZ suggested retail price for all warranted parts replaced, and labor charges based on standard DEUTZ repair time and standard labor rate.

As a condition of reimbursement, replaced parts and receipted invoices must be presented at a DEUTZ distributor facility or other authorized DEUTZ facility.

### **Limitations and Responsibilities**

The warranty is subject to the following conditions:

#### **DEUTZ Responsibilities:**

During the Federal emission warranty period, if a defect in material or workmanship of an emission-related component is found, DEUTZ will provide:

1. New, remanufactured, or repaired components, approved pursuant to EPA regulations, required to correct the defect. Parts replaced under this warranty become the property of DEUTZ.
2. Reasonable and customary labor, during normal working hours, required to make the warranted repair. This includes labor to remove and install the engine, if necessary.

#### **Owner Responsibilities:**

**If you have any questions regarding your warranty rights and responsibilities or the location of the nearest authorized dealer or distributor, you should contact the DEUTZ Service Desk at 1-800-241-9886.**

During the Federal emission warranty period the owner is responsible for:

1. Premium or overtime labor costs.
2. Costs to investigate engine conditions which are not caused by a defect in DEUTZ material or workmanship.
3. Providing timely notice of a warrantable failure and promptly making the product available for repair.
4. Proper maintenance as required in the owner's manual, at owner's expense, such as valve adjustment, fuel and oil filter changes, oil changes, and any other part or service procedure related to emission control.

#### **Limitations:**

DEUTZ is not responsible for resulting damages to an emission-related component resulting from:

1. Any application or installation DEUTZ deems improper.
2. Attachments, accessory items or parts not sold nor approved by DEUTZ.
3. Improper engine maintenance or repair. Engine abuse.
4. Owner's unreasonable delay in making the product available after being notified of a potential product problem.

This warranty is in addition to the DEUTZ standard warranty, applicable to the engine involved. Remedies under this warranty are limited to the provision of material and services as specified herein. DEUTZ is not responsible for incidental or consequential damages.

ORIGINAL



## YOUR WARRANTY RIGHTS AND OBLIGATIONS (Applies only to new engines sold for use in California)

### MODEL YEAR (MY) 2020

The California Air Resources Board (ARB) is pleased to explain the emission control system warranty on your MY 2020 engine. In California, new heavy-duty off-road engines must be designed, built and equipped to meet the State's stringent anti-smog standards. DEUTZ AG (DEUTZ Corporation) must warrant the emission control system on your engine for the periods of time listed below provided there has been no abuse, neglect or improper maintenance of your engine.

Where a warrantable condition exists, DEUTZ will repair your heavy-duty off-road engine at no cost to you including diagnosis, parts and labor at a DEUTZ authorized service dealer.

### MANUFACTURER'S WARRANTY COVERAGE:

The 2020 heavy-duty off-road engines are warranted for five years or 3,000 operating hours, whichever occurs first, from the date the engine is delivered to the ultimate purchaser and each subsequent purchaser for all engines rated at 19kW and greater, except as noted below. In the absence of a device to measure hours of use, the engine shall be warranted for a period of five years. For all engines rated less than 19kW, and for constant-speed engines rated less than 37kW with rated speeds higher than or equal to 3,000 rpm, the period of two years or 1,500 operating hours, whichever occurs first, shall apply. In the absence of a device to measure hours of use, the engine shall be warranted for a period of two years. If any emission-related part on your engine is defective, the part and any other part damaged by it, will be repaired or replaced by DEUTZ.

### OWNER'S WARRANTY RESPONSIBILITIES:

As the heavy-duty off-road engine owner, you are responsible for the performance of the required maintenance listed in your owner's manual. DEUTZ recommends that you retain all receipts covering maintenance on your heavy-duty off-road engine, but DEUTZ cannot deny warranty solely for the lack of receipts or for your failure to ensure the performance of all scheduled maintenance.

As the heavy-duty off-road engine owner, you should however be aware that DEUTZ may deny you warranty coverage if your heavy-duty off-road engine or a part has failed due to abuse, neglect, improper maintenance or unapproved modifications.

Your engine is designed to operate on diesel fuel only. Use of any other fuel may result in your engine no longer operating in compliance with California's emissions requirements.

You are responsible for initiating the warranty process. The ARB suggests that you present your heavy-duty off-road engine to a DEUTZ dealer or distributor as soon as a problem exists. The warranty repairs should be completed by the dealer or distributor as expeditiously as possible.

If you have any questions regarding your warranty rights and responsibilities or the location of the nearest authorized dealer or distributor, you should contact the DEUTZ Service Desk at [1-800-241-9886](tel:1-800-241-9886).

ORIGINAL

**DEUTZ AG**

**DEUTZ Corporation**

3883 Steve Reynolds Blvd. Norcross, GA 30093

Phone: 770-564-9886 Fax: 770-564-7222

E-mail: [service.support@DEUTZusa.com](mailto:service.support@DEUTZusa.com) [www.DEUTZamericas.com](http://www.DEUTZamericas.com)

The engine company.





## CALIFORNIA EMISSION CONTROL WARRANTY STATEMENT

### WARRANTY COVERAGE:

DEUTZ warrants that any MY 2020 heavy-duty off-road diesel cycle engine certified for sale and registered in the State of California is designed, built, and equipped so as to conform with all applicable regulations adopted by the ARB as stated in Manufacturer's warranty coverage above.

The owner shall not be charged for diagnostic labor which leads to the determination that a warranted part is in fact defective, provided that such diagnostic work is performed at an authorized DEUTZ dealer or distributor.

If a warranted part fails because of a defect, DEUTZ will repair or replace it at any authorized DEUTZ dealer or distributor. Any other parts damaged by the failure of a defective part will also be repaired or replaced at no charge to the owner.

Any warranted part which is scheduled for replacement as required maintenance is warranted for the period of time prior to the first scheduled replacement point for that part.

The owner may elect to have the maintenance, replacement or repair of the certified systems and emission control components by using parts other than DEUTZ parts without invalidating this warranty. However, the costs for such services and parts will not be covered under the warranty.

### WARRANTED PARTS:

The following lists of parts are warranted under this California Emissions Control Warranty Statement if applied to the engine:

Emission-related components include any engine parts related to the following systems

#### (1) Fuel Metring system

- (A) Fuel injection system
- (B) Air/fuel ratio feedback and control system.
- (C) Cold start enrichment system.

#### (2) Air Induction System

- (A) Controlled hot air intake system.
- (B) Intake manifold.
- (C) Heat Riser Valve and Assembly.
- (D) Turbocharger/Supercharger Systems.
- (E) Charge Air Cooling Systems.

#### (3) Exhaust Gas Recirculation (EGR) System

- (A) EGR valve body, and carburetor spacer if applicable.
- (B) EGR rate feedback and control system.

#### (4) Air injection System

- (A) Air pump or pulse valve.
- (B) Valves affecting distribution of flow.
- (C) Distribution manifold.

#### (5) Catalyst or Thermal Reactor System

- (A) Catalytic converter.
- (B) Thermal reactor.
- (C) Exhaust manifold

ORIGINAL



## (6) Particulate Controls

- (A) Traps filters, precipitators, and any other device used to capture particulate emissions.
- (B) Regenerators, oxidizers, fuel additive devices, and any other device used to regenerate or aid in the regeneration of - the particulate control device.
- (C) Control Device Enclosures and Manifolding.
- (D) Smoke Puff Limiters.

## (7) Advanced Oxides of Nitrogen (NOx) Controls

- (A) NOx Adsorbers
- (B) Lean NOx Catalysts
- (C) Selective Catalyst Reduction
- (D) Reductant (urea/fuel) containers/dispensing systems

## (8) Positive Crankcase Ventilation (PCV) System

- (A) PCV Valve.
- (B) Oil Filler Cap.

## (9) Miscellaneous items Used in Above Systems

- (A) Vacuum, temperature, and time sensitive valves and switches.
- (B) Electronic control units, sensors, solenoids, and wiring harnesses.
- (C) Hoses, belts, connectors, assemblies, clamps, fittings, tubing, sealing gaskets or devices, and mounting hardware
- (D) Pulleys, belts and idlers.
- (E) Emission Control Information Labels.
- (F) Any other part with the primary purpose of reducing emissions or that can increase emissions during failure without significantly degrading engine performance.

## EXCLUSIONS:

This warranty does not cover:

Any application or installation or maintenance DEUTZ deems improper.

Add-on or modified parts, as defined in Section 1900(b)(1) and (b)(10), Title 13, that are not exempted by the Air Resources Board may not be used. The use of any non-exempted add-on or modified parts shall be grounds for disallowing a warranty claim made in accordance with this article. DEUTZ AG as engine manufacturer shall not be liable under this article to warrant failures of warranted parts caused by the use of a non-exempted add-on or modified part.

Owner's unreasonable delay in making the product available after being notified of a potential product problem.

Damage resulting from fire, accident, negligence, act of God or other events beyond the control of DEUTZ.

Consequential damages such as loss of use of the engine or equipment powered by the engine, towing, loss of time, down time, inconvenience, telephone, travel, lodging, or any other indirect or direct damages.

Loss or damage to personal property, loss of revenue, commercial loss or any other matters not specifically included in this warranty statement.

Damages resulting from use of non-genuine DEUTZ parts or failure to maintain the engine as required in the Operator's Manual.

ORIGINAL

## Exhibit A

### **PORT AUTHORITY OF GUAM FEDERAL CONTRACT SUPPLEMENT**

All boxes marked below are terms and conditions applicable to the Agreement entered by the Port Authority of Guam ("PAG") and Contractor, which is funded in whole or in part by federal award funds, as supplemented with these federally required terms. To the extent that any of the contractual terms, provisions, or conditions of the Agreement are inconsistent with the applicable terms, provisions, or conditions of this Federal Contract Supplement, the applicable terms of this Federal Contract Supplement shall govern.

**DOMESTIC PRODUCTS PREFERENCE**

As appropriate and to the extent consistent with law, there is a preference for the purchase, acquisition, or use of goods, products, or materials produced in the United States (including but not limited to iron, aluminum, steel, cement, and other manufactured products). The requirements of this section must be included in all subcontracts, including all purchase orders for work or products under this subaward. For purposes of this section: "Produced in the United States" means, for iron and steel products, that all manufacturing processes, from the initial melting stage through the application of coatings, occurred in the United States.

**PROHIBITION ON CERTAIN TELECOMMUNICATIONS AND VIDEO SURVEILLANCE SERVICES AND EQUIPMENT**

For the purpose of public safety, security of government facilities, physical security surveillance of critical infrastructure, and other national security purposes, Contractor and all subcontractors are prohibited from procuring, obtaining, or purchasing: 1) equipment, services, or systems that uses covered telecommunications equipment or services as a substantial or essential component of any system, or as critical technology as part of any system. As described in Public Law 115-232, section 889, covered telecommunications equipment is telecommunications equipment produced by Huawei Technologies Company or ZTE Corporation (or any subsidiary or affiliate of such entities); 2) video surveillance and telecommunications equipment produced by Hytera Communications Corporation, Hangzhou Hikvision Digital Technology Company, or Dahua Technology Company (or any subsidiary or affiliate of such entities); 3) telecommunications or video surveillance services provided by such entities or using such equipment; and 4) telecommunications or video surveillance equipment or services produced or provided by an entity that the Secretary of Defense, in consultation with the Director of the National Intelligence or the Director of the Federal Bureau of Investigation, reasonably believes to be an entity owned or controlled by, or otherwise connected to, the government of a covered foreign country.

**PROCUREMENT OF RECOVERED MATERIALS**

Contractor and all subcontractors must comply with section 6002 of the Solid Waste Disposal Act, as amended by the Resource Conservation and Recovery Act. The requirements of Section 6002 include procuring only items designated in guidelines of the Environmental Protection Agency (EPA) at 40 CFR part 247 that contain the highest percentage of recovered materials practicable, consistent with maintaining a satisfactory level of competition, where the purchase price of the item exceeds \$10,000 or the value of the quantity acquired during the preceding fiscal year exceeded \$10,000; procuring solid waste management services in a manner that maximizes energy and resource recovery; and establishing an affirmative procurement program for procurement of recovered materials identified in the EPA guidelines.

**UNALLOWABLE COSTS**

Contractor agrees to comply with all applicable laws, regulations, policies, and guidance (including specific cost limits, prior approval and reporting requirements, where applicable) governing the use of federal funds. Costs that are expressly unallowable under federal funding laws, or costs which specifically become designated as unallowable as a result of a written decision furnished by a contracting officer pursuant to contract dispute procedures, or costs which are mutually agreed to be unallowable, including mutually agreed to be unallowable directly associated costs, shall be identified and excluded from any invoice, billing, claim, or proposal applicable to a federally funded contract. A directly associated cost is any cost which is generated solely as a result of incurring another cost, and which would not have been incurred had the other cost not been incurred. When an

unallowable cost is incurred, its directly associated costs are also unallowable. Contractor agrees to pay any penalties associated with any unallowable costs.

**NO OBLIGATION BY THE FEDERAL GOVERNMENT**

PAG and Contractor acknowledge and agree that, notwithstanding any concurrence by the Federal Government in or approval of the solicitation or award of the underlying Agreement, absent the express written consent by the Federal Government, the Federal Government is not a party to this contract and shall not be subject to any obligations or liabilities to PAG. Contractor, or any other party (whether or not a party to the contract) pertaining to any matter resulting from the underlying contract. Contractor agrees to include the above clause in each subcontract financed in whole or in part with Federal funds under this Agreement. It is further agreed that the clause shall not be modified, except to identify the subcontractor who will be subject to its provisions.

**FEDERAL LOBBYING**

The Contractor certifies, to the best of his or her knowledge and belief, that:

A. No Federal appropriated funds have been paid or will be paid, by or on behalf of the undersigned, to any person for influencing or attempting to influence an officer or employee of an agency, a Member of Congress, an officer or employee of Congress, or an employee of a Member of Congress in connection with the awarding of this Agreement, the making of any Federal grant, the making of any Federal loan, the entering into of any cooperative agreement, and the extension, continuation, renewal, amendment, or modification of this Agreement or any Federal grant, loan, or cooperative agreement.

B. If any funds other than Federal appropriated funds have been paid or will be paid to any person for making lobbying contacts to an officer or employee of any agency, a Member of Congress, an officer or employee of Congress, or an employee of a Member of Congress in connection with this Agreement, or any Federal grant, loan, or cooperative agreement, the undersigned shall complete and submit Standard Form--LLL, "Disclosure Form to Report Lobbying," in accordance with its instructions [as amended by "Government wide Guidance for New Restrictions on Lobbying," 61 Fed. Reg. 1413 (1/19/96). Note: Language in paragraph (2) herein has been modified in accordance with Section 10 of the Lobbying Disclosure Act of 1995 (P.L. 104-65, to be codified at 2 U.S.C. 1601, et seq.)]

C. The Contractor shall require that the language of this certification be included in the award documents for all subawards at all tiers (including subcontracts, subgrants, and contracts under grants, loans, and cooperative agreements) and that all subcontractors shall certify and disclose accordingly.

D. This certification is a material representation of fact upon which reliance was placed when this transaction was made or entered into. Submission of this certification is a prerequisite for making or entering into this Agreement. The Contractor certifies or affirms the truthfulness and accuracy of each statement of this certification and disclosure. In addition, the Contractor understands and agrees that the provisions of 31 U.S.C. A 3801, et seq., apply to this certification and disclosure.

**ALL PUBLISHED ITEMS AND DELIVERABLES MUST INCLUDE NAME OF FEDERAL AWARDING AGENCY AND AWARD NUMBER**

Contractor agrees to include the Program logo and the logos of the Federal Awarding Agency, the PAG, and the government of Guam on any materials developed for publication. Contractor further agrees to ensure statements, press releases, public service announcements, media interviews, requests for proposals, bid solicitations, and other documents or activities carried out in whole or part with program funds shall clearly state: (1) the dollar amount of federal funds for the project; (2) the Federal Award Number; and (3) the involvement of the Federal Awarding Agency, the PAG, and the government of Guam.

**DEBARMENT (GUAM AND FEDERAL)**

A. **Guam Debarment and Suspension.** Contractor warrants that it will comply with the provisions of 5 GCA Chapter 5 Articles 9 and 11, subject to debarment or suspension, and that it will not employ any subcontractors who have been federally debarred or debarred by the Government of Guam.

B. **Federal Debarment and Suspension (Executive Orders 12549 and 12689).** A contract award (see 2 CFR 180.220) must not be made to parties listed on the government-wide exclusions in the System for Award



Management (SAM), in accordance with the OMB guidelines at 2 CFR 180 that implement Executive Orders 12549 (3 CFR part 1986 Comp., p. 189) and 12689 (3 CFR part 1989 Comp., p. 235), "Debarment and Suspension." SAM Exclusions contains the names of parties debarred, suspended, or otherwise excluded by agencies, as well as parties declared ineligible under statutory or regulatory authority other than Executive Order 12549. As required by Executive Order 12549, Debarment and Suspension, and implemented at 34 CFR Part 85, for prospective participants in primary covered transactions, as defined at 34 CFR Part 85, Sections 85.105 and 85.110. The Contractor certifies that it and its principals: 1) Are not presently debarred, suspended, proposed for debarment, declared ineligible, or voluntarily excluded from covered transactions by any federal department or agency; 2) Have not within a three-year period preceding this application been convicted of or had a civil judgment rendered against them for commission of fraud or a criminal offense in connection with obtaining, attempting to obtain, or performing a public (federal, state, or local) transaction or contract under a public transaction; violation of federal or state antitrust statutes or commission of embezzlement, theft, forgery, bribery, falsification or destruction of records, making false statements, or receiving stolen property; 3) Are not presently indicted for or otherwise criminally or civilly charged by a governmental entity (federal, state, or local) with commission of any of the offenses enumerated above; and 4) Have not within a three-year period preceding this application had one or more public transactions (federal, state, or local) terminated for cause or default. Contractor further warrants that it is not a party listed on the government wide exclusions in the System for Award Management (SAM), and will comply with the provisions of Subpart C of 2 CFR Part 1326, "Nonprocurement Debarment and Suspension," (published in the Federal Register on December 21, 2006, 71 FR 76573) which generally prohibits entities that have been debarred, suspended, or voluntarily excluded from participating in nonprocurement transactions either through primary or lower tier covered transactions, and which sets forth the responsibilities of recipients of federal financial assistance regarding transactions with other persons, including subrecipients and contractors. Contractor will provide a Certification Regarding Debarment, Suspension, Ineligibility, and Voluntary Exclusion, Lower Tier Covered Transaction (Sub-Recipient), which is a material representation of fact. Submission of this certification is a pre-requisite for entering into this Agreement, imposed by Executive Order 12549, 28 CFR Part 67, Section 67.510.

**ACCESS TO RECORDS, INSPECTION, AND AUDIT REVIEW**

A. **Access to Records.** The Contractor, including its subcontractors, if any, shall maintain all books, documents, papers, accounting records and other evidence pertaining to costs incurred and to make such materials available at their respective office at all reasonable times during the contract period and for three (3) years from the date of final payment under this Formal Agreement, for inspection by the PAG. Each subcontract by the Contractor pursuant to this Agreement shall include a provision containing the conditions of this Section.

B. **Right to Audit.** Contractor shall establish and maintain a reasonable accounting system that enables the PAG to readily identify Contractor's assets, expenses, costs of goods, and use of funds. the PAG and its authorized representatives shall have the right to audit, to examine, and to make copies of or extracts from all financial and related records (in whatever form they may be kept, whether written, electronic, or other) relating to or pertaining to this Agreement kept by or under the control of the Contractor, including, but not limited to those kept by the Contractor, its employees, agents, assigns, successors, and subcontractors. Such records shall include, but not be limited to, accounting records, written policies and procedures; subcontract files (including proposals of successful and unsuccessful bidders, bid recaps, etc.); all paid vouchers including those for out-of-pocket expenses; other reimbursement supported by invoices; ledgers; cancelled checks; deposit slips; bank statements; journals; original estimates; estimating work sheets; contract amendments and change order files; backcharge logs and supporting documentation; insurance documents; payroll documents; timesheets; memoranda; and correspondence. Contractor shall, at all times during the term of this Agreement and for a period of ten years after the completion of this Agreement, maintain such records, together with such supporting or underlying documents and materials. The Contractor shall at any time requested by the PAG, whether during or after completion of this Agreement, and at Contractor's own expense make such records available for inspection and audit (including copies and extracts of records as required) by the PAG. Such records shall be made available to the PAG during normal business hours at the Contractor's office or place of business and [subject to a three-day written notice/without prior notice]. In the event that no such location is available, then the financial records, together with the supporting or underlying documents and records, shall be made available for audit at a time and location that is convenient for the PAG. Contractor shall ensure the PAG has these rights with Contractor's employees, agents, assigns, successors, and subcontractors, and the obligations of these rights shall be explicitly included in any subcontracts or agreements formed between the Contractor and any subcontractors to the extent that those subcontracts or agreements relate to fulfillment of the Contractor's obligations to the PAG. Costs of any audits conducted under the authority of this right to audit and not addressed elsewhere will be borne by the PAG unless certain exemption criteria are met. If the audit identifies overpricing or overcharges (of any nature) by the Contractor to the PAG in excess of one-half of one percent (.5%) of the total contract billings, the Contractor shall reimburse the PAG for the total costs of the audit. If the audit discovers substantive findings related to fraud, misrepresentation, or non-performance, the PAG may recoup the costs of the audit work from the Contractor. Any adjustments and/or payments that must be made as a result of any such audit or inspection of the Contractor's

invoices and/or records shall be made within a reasonable amount of time (not to exceed 90 days) from presentation of the PAG's findings to Contractor.

C. **Right to Enter and Inspect.** the PAG may, at any time, without notice, enter and inspect a Contractor's or subcontractor's facilities, place(s) of business, or any place(s) of performance of this Agreement. the PAG may enter and inspect any plans, supplies, services, equipment, work and records at these locations which are related to the performance of this Agreement, and may conduct any testing deemed necessary to determine whether the Contractor's or subcontractor's compliance or conformity to the solicitation or contract requirements. Guam may enter and audit the cost or pricing data, books, and records of the Contractor or any subcontractor, and/or investigate in connection with an action to debar or suspend a person from consideration for award of contracts pursuant to §9102 (Authority to Debar or Suspend) of the Guam Procurement Rules and Regulations.

**FEDERAL REQUIREMENTS**

Contractor agrees to comply with all applicable federal law, regulations, and executive orders, all standards, orders, requirements set forth under the federal award that is funding this Agreement, and all policies, procedures, and directives issued by the Federal Awarding Agency.

**MODIFICATION**

This Agreement may only be amended, modified, or extended in accordance with the applicable federal law, the terms and conditions of the federal award that is funding this Agreement, and the policies and procedures of the Federal Awarding Agency. Deviations from budget, project scope, objective, and/or time of performance require notification to the Federal Awarding Agency, and may require prior approval of the Federal Awarding Agency.

**FALSE CLAIMS AND WHISTLEBLOWERS**

Contractor acknowledges that 31 U.S.C. Chap. 38 (Administrative Remedies for False Claims and Statements) and Title 5 GCA Chapter 37, the False Claims and Whistleblower Act applies to this Agreement and to all Contractor's actions pertaining to this Agreement. The False Claims and Whistleblower Act was passed as Public Law 34-116, Chapter III, Section 20 (lapsed into law August 24, 2018) and codified at Title 5 GCA Chapter 37.

**IMPLEMENTATION OF CLEAN AIR ACT AND FEDERAL WATER POLLUTION CONTROL ACT**

(APPLICABLE TO ALL CONTRACTS AND SUBCONTRACTS EXCEEDING \$150,000)

Contractor agrees to comply with all applicable standards, orders, or requirements issued under Section 306 of the Clean Air Act (42 USC, 1857H), Section 508 of the Clean Water Act (33 USC, 1368), Executive Order 11378, and Environmental Protection Agency regulations (40 C.F.R., Part 15), which prohibit the use under nonexempt federal contracts, grants, or loans of facilities included on the EPA list of Violating Facilities. Contractor shall report violations to the PAG and to the USEPA Assistant Administrator for Enforcement (ENO329).

By executing this contract, and any subcontracts, as appropriate, the Contractor and any subcontractors will be deemed to have stipulated as follows:

A. That any person who is or will be utilized in the performance of this contract is not prohibited from receiving an award due to a violation of Section 508 of the Clean Water Act or Section 306 of the Clean Air Act.

B. That the Contractor agrees to include or cause to be included the requirements of paragraph (A) of this Section in every subcontract, and further agrees to take such action as the contracting agency may direct as a means of enforcing such requirements.

**EQUAL EMPLOYMENT OPPORTUNITY COMPLIANCE**

(APPLICABLE TO ALL CONSTRUCTION CONTRACTS AND SUBCONTRACTS)

The Contractor and all subcontractors must comply with the following policies: Executive Order 11246, 41 CFR 60, 29 CFR 1625-1627, Title 23 USC Section 140, the Rehabilitation Act of 1973, as amended (29 USC 794), Title VI of the Civil Rights Act of 1964, as amended, and related regulations including 49 CFR Parts 21, 26 and 27; and 23 CFR Parts 200, 230, and 633.

The Contractor and all subcontractors must also comply with: the requirements of the Equal Opportunity Clause in 41 CFR 60-1.4(b) and, for all construction contracts exceeding \$10,000, the Standard Federal Equal Employment Opportunity Construction Contract Specifications in 41 CFR 60-4.3.

A. Equal Employment Opportunity: Equal employment opportunity (EEO) requirements not to discriminate and to take affirmative action to assure equal opportunity as set forth under laws, executive orders, rules, regulations (28 CFR 35, 29 CFR 1630, 29 CFR 1625-1627, 41 CFR 60 and 49 CFR 27) and orders of the Secretary of Labor as modified by the provisions prescribed herein, and imposed pursuant to 23 U.S.C. 140 shall constitute the EEO and specific affirmative action standards for the Contractor's project activities under this contract. The provisions of the Americans with Disabilities Act of 1990 (42 U.S.C. 12101 et seq.) set forth under 28 CFR 35 and 29 CFR 1630 are incorporated by reference in this contract. In the execution of this contract, the Contractor agrees to comply with the following minimum specific requirement activities of EEO:

1) The Contractor will work with the PAG and the Federal Government to ensure that it has made every good faith effort to provide equal opportunity with respect to all of its terms and conditions of employment and in their review of activities under the contract.

2) The Contractor will accept as its operating policy the following statement:

"It is the policy of this Company to assure that applicants are employed, and that employees are treated during employment, without regard to their race, religion, sex, color, national origin, age or disability. Such action shall include: employment, upgrading, demotion, or transfer; recruitment or recruitment advertising; layoff or termination; rates of pay or other forms of compensation; and selection for training, including apprenticeship, pre-apprenticeship, and/or on-the-job training."

B. EEO Officer: The Contractor will designate and make known to the contracting officers an EEO Officer who will have the responsibility for and must be capable of effectively administering and promoting an active EEO program and who must be assigned adequate authority and responsibility to do so.

C. Dissemination of Policy: All members of the Contractor's staff who are authorized to hire, supervise, promote, and discharge employees, or who recommend such action, or who are substantially involved in such action, will be made fully cognizant of, and will implement, the Contractor's EEO policy and contractual responsibilities to provide EEO in each grade and classification of employment. To ensure that the above agreement will be met, the following actions will be taken as a minimum:

1) Periodic meetings of supervisory and personnel office employees will be conducted before the start of work and then not less often than once every six months, at which time the Contractor's EEO policy and its implementation will be reviewed and explained. The meetings will be conducted by the EEO Officer.

2) All new supervisory or personnel office employees will be given a thorough indoctrination by the EEO Officer, covering all major aspects of the Contractor's EEO obligations within thirty days following their reporting for duty with the Contractor.

3) All personnel who are engaged in direct recruitment for the project will be instructed by the EEO Officer in the Contractor's procedures for locating and hiring minorities and women.

4) Notices and posters setting forth the Contractor's EEO policy will be placed in areas readily accessible to employees, applicants for employment and potential employees.

5) The Contractor's EEO policy and the procedures to implement such policy will be brought to the attention of employees by means of meetings, employee handbooks, or other appropriate means.

D. Recruitment: When advertising for employees, the Contractor will include in all advertisements for employees the notation: "An Equal Opportunity Employer." All such advertisements will be placed in publications having a large circulation among minorities and women in the area from which the project work force would normally be derived.

1) The Contractor will, unless precluded by a valid bargaining agreement, conduct systematic and direct recruitment through public and private employee referral sources likely to yield qualified minorities and women. To meet this requirement, the Contractor will identify sources of potential minority group employees, and establish with such identified sources procedures whereby minority and women applicants may be referred to the Contractor for employment consideration.

2) In the event the Contractor has a valid bargaining agreement providing for exclusive hiring hall referrals, the Contractor is expected to observe the provisions of that agreement to the extent that the system meets the Contractor's compliance with EEO contract provisions. Where implementation of such an agreement has the effect of discriminating against minorities or women, or obligates the Contractor to do the same, such implementation violates Federal nondiscrimination provisions.

3) The Contractor will encourage its present employees to refer minorities and women as applicants for employment. Information and procedures with regard to referring such applicants will be discussed with employees.

E. Personnel Actions: Wages, working conditions, and employee benefits shall be established and administered, and personnel actions of every type, including hiring, upgrading, promotion, transfer, demotion, layoff, and termination, shall be taken without regard to race, color, religion, sex, national origin, age or disability. The following procedures shall be followed:

1) The Contractor will conduct periodic inspections of project sites to insure that working conditions and employee facilities do not indicate discriminatory treatment of project site personnel.

2) The Contractor will periodically evaluate the spread of wages paid within each classification to determine any evidence of discriminatory wage practices.

3) The Contractor will periodically review selected personnel actions in depth to determine whether there is evidence of discrimination. Where evidence is found, the Contractor will promptly take corrective action. If the review indicates that the discrimination may extend beyond the actions reviewed, such corrective action shall include all affected persons.

4) The Contractor will promptly investigate all complaints of alleged discrimination made to the Contractor in connection with its obligations under this Agreement, will attempt to resolve such complaints, and will take appropriate corrective action within a reasonable time. If the investigation indicates that the discrimination may affect persons other than the complainant, such corrective action shall include such other persons. Upon completion of each investigation, the Contractor will inform every complainant of all of their avenues of appeal.

F. Training and Promotion:

1) The Contractor will assist in locating, qualifying, and increasing the skills of minorities and women who are applicants for employment or current employees. Such efforts should be aimed at developing full journey level status employees in the type of trade or job classification involved.

2) Consistent with the Contractor's work force requirements and as permissible under Federal and State regulations, the Contractor shall make full use of training programs, i.e., apprenticeship, and on-the-job training programs for the geographical area of contract performance. In the event a special provision for training is provided under this Agreement, this subparagraph will be superseded as indicated in the special provision. the PAG may reserve training positions for persons who receive welfare assistance in accordance with 23 U.S.C. 140(a).

3) The Contractor will advise employees and applicants for employment of available training programs and entrance requirements for each.

4) The Contractor will periodically review the training and promotion potential of employees who are minorities and women and will encourage eligible employees to apply for such training and promotion.

G. Unions: If the Contractor relies in whole or in part upon unions as a source of employees, the Contractor will use good faith efforts to obtain the cooperation of such unions to increase opportunities for minorities and women. Actions by the Contractor, either directly or through a contractor's association acting as agent, will include the procedures set forth below:

1) The Contractor will use good faith efforts to develop, in cooperation with the unions, joint training programs aimed toward qualifying more minorities and women for membership in the unions and increasing the skills of minorities and women so that they may qualify for higher paying employment.

2) The Contractor will use good faith efforts to incorporate an EEO clause into each union agreement to the end that such union will be contractually bound to refer applicants without regard to their race, color, religion, sex, national origin, age or disability.

3) The Contractor is to obtain information as to the referral practices and policies of the labor union except that to the extent such information is within the exclusive possession of the labor union and such labor union refuses to furnish such information to the Contractor, the Contractor shall so certify to the PAG and shall set forth what efforts have been made to obtain such information.

4) In the event the union is unable to provide the Contractor with a reasonable flow of referrals within the time limit set forth in the collective bargaining agreement, the Contractor will, through independent recruitment efforts, fill the employment vacancies without regard to race, color, religion, sex, national origin, age or disability; making full efforts to obtain qualified and/or qualifiable minorities and women. The failure of a union to provide sufficient referrals (even though it is obligated to provide exclusive referrals under the terms of a collective bargaining agreement) does not relieve the Contractor from the requirements of this paragraph. In the event the union referral practice prevents the Contractor from meeting the obligations pursuant to Executive Order 11246, as amended, and these special provisions, the Contractor shall immediately notify the PAG.

H. Reasonable Accommodation for Applicants/Employees with Disabilities: The Contractor must be familiar with the requirements for and comply with the Americans with Disabilities Act and all rules and regulations established thereunder. Employers must provide reasonable accommodation in all employment activities unless to do so would cause an undue hardship.

I. Selection of Subcontractors, Procurement of Materials and Leasing of Equipment: The Contractor shall not discriminate on the grounds of race, color, religion, sex, national origin, age or disability in the selection and retention of subcontractors, including procurement of materials and leases of equipment. The Contractor shall take all necessary and reasonable steps to ensure nondiscrimination in the administration of this Agreement.

1) The Contractor shall notify all potential subcontractors and suppliers and lessors of their EEO obligations under this Agreement.

2) The Contractor will use good faith efforts to ensure subcontractor compliance with their EEO obligations.

J. Records and Reports: The Contractor shall keep such records as necessary to document compliance with the EEO requirements. Such records shall be retained for a period of three years following the date of the final payment to the Contractor for all the Work under this Agreement and shall be available at reasonable times and places for inspection by authorized representatives of the PAG.

1) The records kept by the Contractor shall document the following:

(a) The number and work hours of minority and non-minority group members and women employed in each work classification on the project;

(b) The progress and efforts being made in cooperation with unions, when applicable, to increase employment opportunities for minorities and women; and

(c) The progress and efforts being made in locating, hiring, training, qualifying, and upgrading minorities and women;

2) The Contractor and any subcontractors will submit an annual report to the PAG each July for the duration of the Project, indicating the number of minority, women, and non-minority group employees currently engaged in each work classification required by the Work under this Agreement. The staffing data should represent the project work force on board in all or any part of the last payroll period preceding the end of July. If on-the-job training is being required by special provision, the Contractor will be required to collect and report training data. The employment data should reflect the work force on board during all or any part of the last payroll period preceding the end of July.

**NONSEGREGATED FACILITIES**

(APPLICABLE TO ALL CONSTRUCTION CONTRACTS AND SUBCONTRACTS)

The Contractor must ensure that facilities provided for employees are provided in such a manner that segregation on the basis of race, color, religion, sex, or national origin cannot result. The Contractor may neither require such segregated use by written or oral policies nor tolerate such use by employee custom. The Contractor's obligation extends further to ensure that its employees are not assigned to perform their services at any location, under the Contractor's control, where the facilities are segregated. The term "facilities" includes waiting rooms, work areas, restaurants and other eating areas, time clocks, restrooms, washrooms, locker rooms, and other storage or dressing areas, parking lots, drinking fountains, recreation or entertainment areas, transportation, and housing provided for employees. The Contractor shall provide separate or single-user restrooms and necessary dressing or sleeping areas to assure privacy between sexes.

**DAVIS-BACON ACT COMPLIANCE**

(APPLICABLE TO ALL CONSTRUCTION CONTRACTS AND SUBCONTRACTS EXCEEDING \$2,000)

**A. Minimum wages**

1) All laborers and mechanics employed or working upon the site of the work, will be paid unconditionally and not less often than once a week, and without subsequent deduction or rebate on any account (except such payroll deductions as are permitted by regulations issued by the Secretary of Labor under the Copeland Act (29 CFR part 3)), the full amount of wages and bona fide fringe benefits (or cash equivalents thereof) due at time of payment computed at rates not less than those contained in the wage determination of the Secretary of Labor which is attached hereto and made a part hereof, regardless of any contractual relationship which may be alleged to exist between the Contractor and such laborers and mechanics.

Contributions made or costs reasonably anticipated for bona fide fringe benefits under section 1(b)(2) of the Davis-Bacon Act on behalf of laborers or mechanics are considered wages paid to such laborers or mechanics, subject to the provisions of paragraph 1.d. of this section; also, regular contributions made or costs incurred for more than a weekly period (but not less often than quarterly) under plans, funds, or programs which cover the

particular weekly period, are deemed to be constructively made or incurred during such weekly period. Such laborers and mechanics shall be paid the appropriate wage rate and fringe benefits on the wage determination for the classification of work actually performed, without regard to skill, except as provided in 29 CFR 5.5(a)(4). Laborers or mechanics performing work in more than one classification may be compensated at the rate specified for each classification for the time actually worked therein: Provided, That the employer's payroll records accurately set forth the time spent in each classification in which work is performed. The wage determination (including any additional classification and wage rates conformed under paragraph 1.b. of this section) and the Davis-Bacon poster (WH-1321) shall be posted at all times by the Contractor and its subcontractors at the site of the work in a prominent and accessible place where it can be easily seen by the workers.

2) The contracting officer shall require that any class of laborers or mechanics, including helpers, which is not listed in the wage determination and which is to be employed under the contract shall be classified in conformance with the wage determination. The contracting officer shall approve an additional classification and wage rate and fringe benefits therefore only when the following criteria have been met:

- (i) The work to be performed by the classification requested is not performed by a classification in the wage determination; and
- (ii) The classification is utilized in the area by the construction industry; and
- (iii) The proposed wage rate, including any bona fide fringe benefits, bears a reasonable relationship to the wage rates contained in the wage determination.

3) If the Contractor and the laborers and mechanics to be employed in the classification (if known), or their representatives, and the contracting officer agree on the classification and wage rate (including the amount designated for fringe benefits where appropriate), a report of the action taken shall be sent by the contracting officer to the Administrator of the Wage and Hour Division, Employment Standards Administration, U.S. Department of Labor, Washington, DC 20210. The Administrator, or an authorized representative, will approve, modify, or disapprove every additional classification action within 30 days of receipt and so advise the contracting officer or will notify the contracting officer within the 30-day period that additional time is necessary.

4) In the event the Contractor, the laborers or mechanics to be employed in the classification or their representatives, and the contracting officer do not agree on the proposed classification and wage rate (including the amount designated for fringe benefits, where appropriate), the contracting officer shall refer the questions, including the views of all interested parties and the recommendation of the contracting officer, to the Wage and Hour Administrator for determination. The Wage and Hour Administrator, or an authorized representative, will issue a determination within 30 days of receipt and so advise the contracting officer or will notify the contracting officer within the 30-day period that additional time is necessary.

5) The wage rate (including fringe benefits where appropriate) determined pursuant to paragraphs 1.b.(2) or 1.b.(3) of this section, shall be paid to all workers performing work in the classification under this contract from the first day on which work is performed in the classification.

6) Whenever the minimum wage rate prescribed in the contract for a class of laborers or mechanics includes a fringe benefit which is not expressed as an hourly rate, the Contractor shall either pay the benefit as stated in the wage determination or shall pay another bona fide fringe benefit or an hourly cash equivalent thereof.

7) If the Contractor does not make payments to a trustee or other third person, the Contractor may consider as part of the wages of any laborer or mechanic the amount of any costs reasonably anticipated in providing bona fide fringe benefits under a plan or program, Provided, That the Secretary of Labor has found, upon the written request of the Contractor, that the applicable standards of the Davis-Bacon Act have been met. The Secretary of Labor may require the Contractor to set aside, in a separate account, assets for the meeting of obligations under the plan or program.

## **B. Withholding**

The contracting agency shall upon its own action or upon written request of an authorized representative of the Department of Labor, withhold or cause to be withheld from the Contractor under this contract, or any other Federal contract with the same prime Contractor, or any other federally-assisted contract subject to Davis-Bacon prevailing wage requirements, which is held by the same prime Contractor, so much of the accrued payments or advances as may be considered necessary to pay laborers and mechanics, including apprentices, trainees, and helpers, employed by the Contractor or any subcontractor the full amount of wages required by the contract. In the event of failure to pay any laborer or mechanic, including any apprentice, trainee, or helper, employed or working on the site of the work, all or part of the wages required by the contract, the PAG may, after written

notice to the Contractor, take such action as may be necessary to cause the suspension of any further payment, advance, or guarantee of funds until such violations have ceased.

### C. Payrolls and Basic Records

1) Payrolls and basic records relating thereto shall be maintained by the Contractor during the course of the work and preserved for a period of three years thereafter for all laborers and mechanics working at the site of the work. Such records shall contain the name, address, and social security number of each such worker, his or her correct classification, hourly rates of wages paid (including rates of contributions or costs anticipated for bona fide fringe benefits or cash equivalents thereof of the types described in section 1(b)(2)(B) of the Davis-Bacon Act), daily and weekly number of hours worked, deductions made and actual wages paid. Whenever the Secretary of Labor has found under 29 CFR 5.5(a)(1)(iv) that the wages of any laborer or mechanic include the amount of any costs reasonably anticipated in providing benefits under a plan or program described in section 1(b)(2)(B) of the Davis-Bacon Act, the Contractor shall maintain records which show that the commitment to provide such benefits is enforceable, that the plan or program is financially responsible, and that the plan or program has been communicated in writing to the laborers or mechanics affected, and records which show the costs anticipated or the actual cost incurred in providing such benefits. Contractors employing apprentices or trainees under approved programs shall maintain written evidence of the registration of apprenticeship programs and certification of trainee programs, the registration of the apprentices and trainees, and the ratios and wage rates prescribed in the applicable programs.

2) The Contractor shall submit weekly for each week in which any contract work is performed a copy of all payrolls to the PAG. The payrolls submitted shall set out accurately and completely all of the information required to be maintained under 29 CFR 5.5(a)(3)(i), except that full social security numbers and home addresses shall not be included on weekly transmittals. Instead the payrolls shall only need to include an individually identifying number for each employee (e.g., the last four digits of the employee's social security number). The required weekly payroll information may be submitted in any form desired. Optional Form WH-347 is available for this purpose from the Wage and Hour Division Web site at <http://www.dol.gov/esa/whd/forms/wh347instr.htm> or its successor site. The prime Contractor is responsible for the submission of copies of payrolls by all subcontractors. Contractors and subcontractors shall maintain the full social security number and current address of each covered worker, and shall provide them upon request to the PAG for transmission to the Wage and Hour Division of the Department of Labor for purposes of an investigation or audit of compliance with prevailing wage requirements. It is not a violation of this section for a prime contractor to require a subcontractor to provide addresses and social security numbers to the prime contractor for its own records, without weekly submission to the PAG.

3) Each payroll submitted shall be accompanied by a "Statement of Compliance," signed by the Contractor or subcontractor or his or her agent who pays or supervises the payment of the persons employed under the contract and shall certify the following:

- (i) That the payroll for the payroll period contains the information required to be provided under §5.5(a)(3)(ii) of Regulations, 29 CFR part 5, the appropriate information is being maintained under §5.5(a)(3)(i) of Regulations, 29 CFR part 5, and that such information is correct and complete;
- (ii) That each laborer or mechanic (including each helper, apprentice, and trainee) employed on the contract during the payroll period has been paid the full weekly wages earned, without rebate, either directly or indirectly, and that no deductions have been made either directly or indirectly from the full wages earned, other than permissible deductions as set forth in Regulations, 29 CFR part 3;
- (iii) That each laborer or mechanic has been paid not less than the applicable wage rates and fringe benefits or cash equivalents for the classification of work performed, as specified in the applicable wage determination incorporated into the contract.

4) The weekly submission of a properly executed certification set forth on the reverse side of Optional Form WH-347 shall satisfy the requirement for submission of the "Statement of Compliance" required by paragraph 3.b.(2) of this section.

5) The falsification of any of the above certifications may subject the Contractor or subcontractor to civil or criminal prosecution under section 1001 of title 18 and section 231 of title 31 of the United States Code.

6) The Contractor or subcontractor shall make the records required under this section available for inspection, copying, or transcription by authorized representatives of the contracting agency or the Department of Labor, and shall permit such representatives to interview employees during working hours on the job. If the Contractor or subcontractor fails to submit the required records or to make them available, the Federal granting agency may, after written notice to the Contractor, or the contracting agency, take such action as may be necessary to cause the suspension of any further payment, advance, or guarantee of funds. Furthermore, failure to submit the required

records upon request or to make such records available may be grounds for debarment action pursuant to 29 CFR 5.12.

**D. Apprentices and trainees**

1) Apprentices (programs of the USDOL).

Apprentices will be permitted to work at less than the predetermined rate for the work they performed when they are employed pursuant to and individually registered in a bona fide apprenticeship program registered with the U.S. Department of Labor, Employment and Training Administration, Office of Apprenticeship Training, Employer and Labor Services, or with a State Apprenticeship Agency recognized by the Office, or if a person is employed in his or her first 90 days of probationary employment as an apprentice in such an apprenticeship program, who is not individually registered in the program, but who has been certified by the Office of Apprenticeship Training, Employer and Labor Services or a State Apprenticeship Agency (where appropriate) to be eligible for probationary employment as an apprentice.

The allowable ratio of apprentices to journeymen on the job site in any craft classification shall not be greater than the ratio permitted to the Contractor as to the entire work force under the registered program. Any worker listed on a payroll at an apprentice wage rate, who is not registered or otherwise employed as stated above, shall be paid not less than the applicable wage rate on the wage determination for the classification of work actually performed. In addition, any apprentice performing work on the job site in excess of the ratio permitted under the registered program shall be paid not less than the applicable wage rate on the wage determination for the work actually performed. Where a contractor is performing construction on a project in a locality other than that in which its program is registered, the ratios and wage rates (expressed in percentages of the journeyman's hourly rate) specified in the Contractor's or subcontractor's registered program shall be observed.

Every apprentice must be paid at not less than the rate specified in the registered program for the apprentice's level of progress, expressed as a percentage of the journeymen hourly rate specified in the applicable wage determination. Apprentices shall be paid fringe benefits in accordance with the provisions of the apprenticeship program. If the apprenticeship program does not specify fringe benefits, apprentices must be paid the full amount of fringe benefits listed on the wage determination for the applicable classification. If the Administrator determines that a different practice prevails for the applicable apprentice classification, fringes shall be paid in accordance with that determination.

In the event the Office of Apprenticeship Training, Employer and Labor Services, or a State Apprenticeship Agency recognized by the Office, withdraws approval of an apprenticeship program, the Contractor will no longer be permitted to utilize apprentices at less than the applicable predetermined rate for the work performed until an acceptable program is approved.

2) Trainees (programs of the USDOL).

Except as provided in 29 CFR 5.16, trainees will not be permitted to work at less than the predetermined rate for the work performed unless they are employed pursuant to and individually registered in a program which has received prior approval, evidenced by formal certification by the U.S. Department of Labor, Employment and Training Administration.

The ratio of trainees to journeymen on the job site shall not be greater than permitted under the plan approved by the Employment and Training Administration.

Every trainee must be paid at not less than the rate specified in the approved program for the trainee's level of progress, expressed as a percentage of the journeyman hourly rate specified in the applicable wage determination. Trainees shall be paid fringe benefits in accordance with the provisions of the trainee program. If the trainee program does not mention fringe benefits, trainees shall be paid the full amount of fringe benefits listed on the wage determination unless the Administrator of the Wage and Hour Division determines that there is an apprenticeship program associated with the corresponding journeyman wage rate on the wage determination which provides for less than full fringe benefits for apprentices. Any employee listed on the payroll at a trainee rate who is not registered and participating in a training plan approved by the Employment and Training Administration shall be paid not less than the applicable wage rate on the wage determination for the classification of work actually performed. In addition, any trainee performing work on the job site in excess of the ratio permitted under the registered program shall be paid not less than the applicable wage rate on the wage determination for the work actually performed.

In the event the Employment and Training Administration withdraws approval of a training program, the Contractor will no longer be permitted to utilize trainees at less than the applicable predetermined rate for the work performed until an acceptable program is approved.



3) Equal employment opportunity. The utilization of apprentices, trainees and journeymen under this part shall be in conformity with the equal employment opportunity requirements of Executive Order 11246, as amended, and 29 CFR part 30.

**E. Compliance with Copeland Act requirements.** The Contractor shall comply with the requirements of 29 CFR part 3, which are incorporated by reference in this contract.

**F. Subcontracts.** The Contractor or subcontractor shall insert in any subcontracts the clauses contained in 29 CFR 5.5(a)(1) through (10) and such other clauses as the (write in the name of the Federal agency) may by appropriate instructions require, and also a clause requiring the subcontractors to include these clauses in any lower tier subcontracts. The prime Contractor shall be responsible for the compliance by any subcontractor or lower tier subcontractor with all the contract clauses in 29 CFR 5.5.

**G. Contract termination: debarment.** A breach of the contract clauses in 29 CFR 5.5 may be grounds for termination of the contract, and for debarment as a contractor and a subcontractor as provided in 29 CFR 5.12.

**H. Compliance with Davis-Bacon and Related Act requirements.** All rulings and interpretations of the Davis-Bacon and Related Acts contained in 29 CFR parts 1, 3, and 5 are herein incorporated by reference in this contract.

**I. Disputes concerning labor standards.** Disputes arising out of the labor standards provisions of this contract shall not be subject to the general disputes clause of this contract. Such disputes shall be resolved in accordance with the procedures of the Department of Labor set forth in 29 CFR parts 5, 6, and 7. Disputes within the meaning of this clause include disputes between the Contractor (or any of its subcontractors) and the PAG, the U.S. Department of Labor, or the employees or their representatives.

**J. Certification of eligibility.**

1) By entering into this contract, the Contractor certifies that neither it (nor he or she) nor any person or firm who has an interest in the Contractor's firm is a person or firm ineligible to be awarded Government contracts by virtue of section 3(a) of the Davis-Bacon Act or 29 CFR 5.12(a)(1).

2) No part of this contract shall be subcontracted to any person or firm ineligible for award of a Government contract by virtue of section 3(a) of the Davis-Bacon Act or 29 CFR 5.12(a)(1).

3) The penalty for making false statements is prescribed in the U.S. Criminal Code, 18 U.S.C. 1001.

**CONTRACT WORK HOURS AND SAFETY STANDARDS ACT**  
(APPLICABLE TO ALL CONTRACTS AND SUBCONTRACTS EXCEEDING \$100,000 AND INVOLVING EMPLOYMENT OF MECHANICS AND LABORERS)

As used in these paragraphs, the terms laborers and mechanics include watchmen and guards.

**A. Overtime requirements.** No contractor or subcontractor contracting for any part of the contract Work which may require or involve the employment of laborers or mechanics shall require or permit any such laborer or mechanic in any workweek in which he or she is employed on such work to work in excess of forty hours in such workweek unless such laborer or mechanic receives compensation at a rate not less than one and one-half times the basic rate of pay for all hours worked in excess of forty hours in such workweek.

**B. Violation; liability for unpaid wages; liquidated damages.** In the event of any violation of this section, the Contractor and any subcontractor responsible therefore shall be liable for the unpaid wages. In addition, such Contractor and subcontractor shall be liable to the United States (in the case of work done under contract for the District of Columbia or a territory, to such District or to such territory), for liquidated damages. Such liquidated damages shall be computed with respect to each individual laborer or mechanic, including watchmen and guards, employed in violation of the clause set forth in this section, in the sum of \$10 for each calendar day on which such individual was required or permitted to work in excess of the standard workweek of forty hours without payment of the overtime wages required by this section.

**C. Withholding for unpaid wages and liquidated damages.** the PAG shall upon its own action or upon written request of an authorized representative of the Department of Labor withhold or cause to be withheld, from any moneys payable on account of work performed by the Contractor or subcontractor under any such contract or any other Federal contract with the same prime Contractor, or any other federally-assisted contract subject to the Contract Work Hours and Safety Standards Act, which is held by the same prime Contractor, such sums as

ORIGINAL

may be determined to be necessary to satisfy any liabilities of such Contractor or subcontractor for unpaid wages and liquidated damages as provided in the clause set forth in this section.

**D. Subcontracts.** The Contractor or subcontractor shall insert in any subcontracts the clauses set forth in this section and also a clause requiring the subcontractors to include these clauses in any lower tier subcontracts. The prime Contractor shall be responsible for compliance by any subcontractor or lower tier subcontractor with the clauses set forth in this section.

**SAFETY: ACCIDENT PREVENTION**  
(APPLICABLE TO ALL CONSTRUCTION CONTRACTS AND SUBCONTRACTS EXCEEDING  
\$100,000)

A. In the performance of this contract the Contractor shall comply with all applicable Federal, State, and local laws governing safety, health, and sanitation. The Contractor shall provide all safeguards, safety devices and protective equipment and take any other needed actions as it determines, or as the contracting officer may determine, to be reasonably necessary to protect the life and health of employees on the job and the safety of the public and to protect property in connection with the performance of the work covered by the contract.

B. It is a condition of this contract, and shall be made a condition of each subcontract, which the Contractor enters into pursuant to this contract, that the Contractor and any subcontractor shall not permit any employee, in performance of the contract, to work in surroundings or under conditions which are unsanitary, hazardous or dangerous to his/her health or safety, as determined under construction safety and health standards (29 CFR 1926) promulgated by the Secretary of Labor, in accordance with Section 107 of the Contract Work Hours and Safety Standards Act (40 U.S.C. 3704).

C. Pursuant to 29 CFR 1926.3, it is a condition of this contract that the Secretary of Labor or authorized representative thereof, shall have right of entry to any site of contract performance to inspect or investigate the matter of compliance with the construction safety and health standards and to carry out the duties of the Secretary under Section 107 of the Contract Work Hours and Safety Standards Act (40 U.S.C.3704).

**D. Hazardous Materials.**

(1) The Contractor is responsible for compliance with any applicable Federal, State, and local laws or requirements regarding hazardous materials. If the Contractor encounters a hazardous material or substance not addressed in this Agreement and if reasonable precautions will be inadequate to prevent foreseeable bodily injury or death to persons resulting from a material or substance, including but not limited to asbestos or polychlorinated biphenyl (PCB), encountered on the site by the Contractor, the Contractor shall, upon recognizing the condition, immediately stop Work in the affected area and report the condition to the PAG and the Project Manager in writing.

(2) The Contractor shall indemnify the PAG for the cost and expense incurred: (1) for remediation of a material or substance the Contractor brings to the site and negligently handles; or (2) where the Contractor fails to perform its obligations, except to the extent that the cost and expense are due to the PAG's fault or negligence.

**E. Emergencies.** In an emergency affecting safety of persons or property, the Contractor shall act, at the Contractor's discretion, to prevent threatened damage, injury or loss.

**DRUG FREE WORKPLACE**

A. The Contractor shall, within 30 days after award:

(1) Publish a statement notifying its employees that the unlawful manufacture, distribution, dispensing, possession, or use of a controlled substance is prohibited in the Contractor's workplace and specifying the actions that will be taken against employees for violations of such prohibition; (2) Establish an ongoing drug-free awareness program to inform such employees about -

(i) The dangers of drug abuse in the workplace;

(ii) The Contractor's policy of maintaining a drug-free workplace;

(iii) Any available drug counseling, rehabilitation, and employee assistance programs; and

(iv) The penalties that may be imposed upon employees for drug abuse violations occurring in the workplace.

(3) Provide all employees engaged in performance of the contract with a copy of the statement required by paragraph (1) of this clause;

(4) Notify such employees in writing in the statement required by subparagraph (b)(1) of this clause that, as a condition of continued employment on this contract, the employee will -

(i) Abide by the terms of the statement; and

- (ii) Notify the employer in writing of the employee's conviction under a criminal drug statute for a violation occurring in the workplace no later than 5 days after such conviction.
- (5) Notify the Procurement Officer in writing within 10 days after receiving notice under subdivision (4)(ii) of this clause, from an employee or otherwise receiving actual notice of such conviction. The notice shall include the position title of the employee;
- (6) Within 30 days after receiving notice under subdivision (4)(ii) of this clause of a conviction, take one of the following actions with respect to any employee who is convicted of a drug abuse violation occurring in the workplace:
- (i) Taking appropriate personnel action against such employee, up to and including termination; or
  - (ii) Require such employee to satisfactorily participate in a drug abuse assistance or rehabilitation program approved for such purposes by a Federal, State, or local health, law enforcement, or other appropriate agency; and
- (7) Make a good faith effort to maintain a drug-free workplace through implementation of paragraphs (1) through (6) of this clause.

B. The Contractor, if an individual, agrees by award of the contract or acceptance of a purchase order, not to engage in the unlawful manufacture, distribution, dispensing, possession, or use of a controlled substance while performing this contract.

C. In addition to other remedies available to the PAG, the Contractor's failure to comply with the requirements of paragraph (B) or (C) of this clause may render the Contractor subject to suspension of contract payments, termination of the contract for default, and suspension or debarment.

**RIGHTS TO INVENTIONS MADE UNDER A CONTRACT OR AGREEMENT**  
(APPLICABLE TO ALL CONTRACTS INVOLVING EXPERIMENTAL, DEVELOPMENTAL, OR RESEARCH WORK BY A SMALL BUSINESS ENTITY OR NON-PROFIT ENTITY)

A. The Contractor must comply with all applicable requirements of 37 CFR Part 401, "Rights to Inventions Made by Nonprofit Organizations and Small Business Firms Under Government Grants, Contracts and Cooperative Agreements," and any implementing regulations issued by the OEA. The interpretation of this clause and this Agreement is subject to the definitions located at 37 CFR § 401.14.

B. The Contractor may retain the entire right, title, and interest throughout the world to each subject invention subject to the provisions of this clause and 35 U.S.C. 203. With respect to any subject invention in which the Contractor retains title, the Federal government shall have a nonexclusive, nontransferable, irrevocable, paid-up license to practice or have practiced for or on behalf of the United States the subject invention throughout the world.

C. **Invention Disclosure, Election of Title and Filing of Patent Application by Contractor**

1. The Contractor will disclose each subject invention to the OEA ("Federal Agency") within two months after the inventor discloses it in writing to Contractor personnel responsible for patent matters. The disclosure to the agency shall be in the form of a written report and shall identify the contract under which the invention was made and the inventor(s). It shall be sufficiently complete in technical detail to convey a clear understanding to the extent known at the time of the disclosure, of the nature, purpose, operation, and the physical, chemical, biological or electrical characteristics of the invention. The disclosure shall also identify any publication, on sale or public use of the invention and whether a manuscript describing the invention has been submitted for publication and, if so, whether it has been accepted for publication at the time of disclosure. In addition, after disclosure to the agency, the Contractor will promptly notify the agency of the acceptance of any manuscript describing the invention for publication or of any on sale or public use planned by the Contractor.

2. The Contractor will elect in writing whether or not to retain title to any such invention by notifying the Federal agency within two years of disclosure to the Federal agency. However, in any case where a patent, a printed publication, public use, sale, or other availability to the public has initiated the one year statutory period wherein valid patent protection can still be obtained in the United States, the period for election of title may be shortened by the agency to a date that is no more than 60 days prior to the end of the statutory period.

3. The Contractor will file its initial patent application on a subject invention to which it elects to retain title within one year after election of title or, if earlier, prior to the end of any statutory period wherein valid patent protection can be obtained in the United States after a publication, on sale, or public use. If the Contractor files a provisional application as its initial patent application, it shall file a non-provisional application within 10 months of the filing of the provisional application. The Contractor will file patent applications in additional countries or international patent offices within either ten months of the first filed patent application or six months from the date permission is granted by the Commissioner of Patents to file foreign patent applications where such filing has been prohibited by a Secrecy Order.

4. For any subject invention with Federal agency and Contractor co-inventors, where the Federal agency employing such co-inventor determines that it would be in the interest of the government, pursuant to 35

[U.S.C. 207\(a\)\(3\)](#), to file an [initial patent application](#) on the [subject invention](#), the Federal agency employing such co-inventor, at its discretion and in consultation with the Contractor, may file such application at its own expense, provided that the Contractor retains the ability to elect title pursuant to [35 U.S.C. 202\(a\)](#).

5. Requests for extension of the time for disclosure, election, and filing under paragraphs (1), (2), and (3) of this clause may, at the discretion of the Federal agency, be granted. When a Contractor has requested an extension for filing a non-provisional application after filing a provisional application, a one-year extension will be granted unless the Federal agency notifies the Contractor within 60 days of receiving the request.

#### **D. Conditions When the Government May Obtain Title**

The Contractor will convey to the Federal agency, upon written request, title to any [subject invention](#):

1. If the Contractor fails to disclose or elect title to the [subject invention](#) within the times specified in paragraph (C) of this clause, or elects not to retain title.

2. In those countries in which the Contractor fails to file [patent applications](#) within the times specified in paragraph (C) of this clause; provided, however, that if the Contractor has filed a [patent application](#) in a country after the times specified in paragraph (C) of this clause, but prior to its receipt of the written request of the Federal agency, the Contractor shall continue to retain title in that country.

3. In any country in which the Contractor decides not to continue the prosecution of any non-provisional [patent application](#) for, to pay a maintenance, annuity or renewal fee on, or to defend in a reexamination or opposition proceeding on, a patent on a [subject invention](#).

#### **E. Minimum Rights to Contractor and Protection of the Contractor Right to File**

1. The Contractor will retain a nonexclusive royalty-free license throughout the world in each [subject invention](#) to which the Government obtains title, except if the Contractor fails to disclose the [invention](#) within the times specified in (C), above. The Contractor's license extends to its domestic subsidiary and affiliates, if any, within the corporate structure of which the Contractor is a party and includes the right to grant sublicenses of the same scope to the extent the Contractor was legally obligated to do so at the time the contract was awarded. The license is transferable only with the approval of the Federal agency except when transferred to the successor of that party of the Contractor's business to which the [invention](#) pertains.

2. The Contractor's domestic license may be revoked or modified by the funding Federal agency to the extent necessary to achieve expeditious [practical application](#) of the [subject invention](#) pursuant to an application for an exclusive license submitted in accordance with applicable provisions at [37 CFR part 404](#) and agency licensing regulations (if any). This license will not be revoked in that field of use or the geographical areas in which the Contractor has achieved [practical application](#) and continues to make the benefits of the [invention](#) reasonably accessible to the public. The license in any foreign country may be revoked or modified at the discretion of the funding Federal agency to the extent the Contractor, its licensees, or the domestic subsidiaries or affiliates have failed to achieve [practical application](#) in that foreign country.

3. Before revocation or modification of the license, the funding Federal agency will furnish the Contractor a written notice of its intention to revoke or modify the license, and the Contractor will be allowed thirty days (or such other time as may be authorized by the funding Federal agency for good cause shown by the Contractor) after the notice to show cause why the license should not be revoked or modified. The Contractor has the right to appeal, in accordance with applicable regulations in [37 CFR part 404](#) and agency regulations (if any) concerning the licensing of Government-owned inventions, any decision concerning the revocation or modification of the license.

#### **F. Contractor Action to Protect the Government's Interest**

1. The Contractor agrees to execute or to have executed and promptly deliver to the Federal agency all instruments necessary to: (i) establish or confirm the rights the Government has throughout the world in those [subject inventions](#) to which the Contractor elects to retain title; and (ii) convey title to the Federal agency when requested under paragraph (D) above and to enable the government to obtain patent protection throughout the world in that [subject invention](#).

2. The Contractor agrees to require, by written agreement, its employees, other than clerical and nontechnical employees, to disclose promptly in writing to personnel identified as responsible for the administration of patent matters and in a format suggested by the Contractor each [subject invention made](#) under contract in order that the Contractor can comply with the disclosure provisions of paragraph (C) of this clause, to assign to the Contractor the entire right, title and interest in and to each [subject invention made](#) under contract, and to execute all papers necessary to file [patent applications](#) on [subject inventions](#) and to establish the government's rights in the [subject inventions](#). This disclosure format should require, as a minimum, the information required by paragraph (C)(1) of this clause. The Contractor shall instruct such employees through employee agreements or other suitable educational programs on the importance of reporting [inventions](#) in sufficient time to permit the filing of [patent applications](#) prior to U.S. or foreign statutory bars.

3. For each [subject invention](#), the Contractor will, no less than 60 days prior to the expiration of the statutory deadline, notify the Federal agency of any decision: Not to continue the prosecution of a non-provisional [patent application](#); not to pay a maintenance, annuity or renewal fee; not to defend in a reexamination or opposition proceeding on a patent, in any country; to request, be a party to, or take action in a trial proceeding before the Patent Trial and Appeals Board of the U.S. Patent and Trademark Office, including but not limited to

post-grant review, review of a business method patent, *inter partes* review, and derivation proceeding; or to request, be a party to, or take action in a non-trial submission of art or information at the U.S. Patent and Trademark Office, including but not limited to a pre-issuance submission, a post-issuance submission, and supplemental examination.

4. The Contractor agrees to include, within the specification of any United States [patent applications](#) and any patent issuing thereon covering a [subject invention](#), the following statement, "This [invention](#) was [made](#) with government support under the Agreement for Professional Technical Advisory Services between Contractor and OOG, awarded by the OOG under Federal Award Number HQ0005171035. The government has certain rights in the [invention](#)."

#### G. Subcontracts

1. The Contractor will include this clause, suitably modified to identify the parties, in all subcontracts, regardless of tier, for experimental, developmental or research work to be performed by a subcontractor. The subcontractor will retain all rights provided for the Contractor in this clause, and the Contractor will not, as part of the consideration for awarding the subcontract, obtain rights in the subcontractor's subject inventions.

2. The Contractor will include in all other subcontracts, regardless of tier, for experimental developmental or research work the patent rights clause required by the FAR or the Terms and Conditions of Federal Award Number HQ0005171035.

3. In the case of subcontracts, at any tier, when the prime award with the Federal agency was a contract (but not a grant or cooperative agreement), the OEA, subcontractor, and the [Contractor](#) agree that the mutual obligations of the parties created by this clause constitute a contract between the subcontractor and the Federal agency with respect to the matters covered by the clause; provided, however, that nothing in this paragraph is intended to confer any jurisdiction under the Contract Disputes Act in connection with proceedings under paragraph (J) of this clause.

#### H. Reporting on Utilization of Subject Inventions

The Contractor agrees to submit on request periodic reports no more frequently than annually on the utilization of a [subject invention](#) or on efforts at obtaining such utilization that are being [made](#) by the Contractor or its licensees or assignees. Such reports shall include information regarding the status of development, date of first commercial sale or use, gross royalties received by the [Contractor](#), and such other data and information as the agency may reasonably specify. The Contractor also agrees to provide additional reports as may be requested by the agency in connection with any march-in proceeding undertaken by the agency in accordance with paragraph (J) of this clause. As required by [35 U.S.C. 202\(c\)\(5\)](#), the agency agrees it will not disclose such information to persons outside the government without permission of the Contractor.

#### I. Preference for United States Industry

Notwithstanding any other provision of this clause, the Contractor agrees that neither it nor any assignee will grant to any person the exclusive right to use or sell any [subject inventions](#) in the United States unless such person agrees that any products embodying the [subject invention](#) or produced through the use of the [subject invention](#) will be manufactured substantially in the United States. However, in individual cases, the requirement for such an agreement may be waived by the Federal agency upon a showing by the Contractor or its assignee that reasonable but unsuccessful efforts have been [made](#) to grant licenses on similar terms to potential licensees that would be likely to manufacture substantially in the United States or that under the circumstances domestic manufacture is not commercially feasible.

#### J. March-in Rights

The Contractor agrees that with respect to any [subject invention](#) in which it has acquired title, the Federal agency has the right in accordance with the procedures in [37 CFR 401.6](#) and any supplemental regulations of the agency to require the Contractor, an assignee or exclusive licensee of a [subject invention](#) to grant a nonexclusive, partially exclusive, or exclusive license in any field of use to a responsible applicant or applicants, upon terms that are reasonable under the circumstances, and if the Contractor, assignee, or exclusive licensee refuses such a request the Federal agency has the right to grant such a license itself if the Federal agency determines that:

1. Such action is necessary because the Contractor or assignee has not taken, or is not expected to take within a reasonable time, effective steps to achieve [practical application](#) of the [subject invention](#) in such field of use.

2. Such action is necessary to alleviate health or safety needs which are not reasonably satisfied by the Contractor, assignee or their licensees;

3. Such action is necessary to meet requirements for public use specified by Federal regulations and such requirements are not reasonably satisfied by the Contractor, assignee or licensees; or

4. Such action is necessary because the agreement required by paragraph (I) of this clause has not been obtained or waived or because a licensee of the exclusive right to use or sell any [subject invention](#) in the United States is in breach of such agreement.



**PORT OF GUAM**

ATURIDAT / PUETTON GUAHAN

Jose D. Leon Guerrero Commercial Port

1026 Cabras Highway, Suite 201, Piti, Guam 96915

Telephone: 671-477-5931/35 Facsimile: 671-477-2689/4445

Website: [www.portguam.com](http://www.portguam.com)



Lourdes A. Leon Guerrero  
Governor of Guam

Joshua F. Tenorio  
Lieutenant Governor

February 14, 2024

INVITATION FOR BID IFB-PAG-004-24  
180' Telescopic Boom Lift  
Questions and Responses

Question submitted by Far East Equipment via e-mail on January 30, 2024

Question #1: Would a boom truck with a working height of 182'11" be acceptable in lieu of a telescopic boom lift? We recommend this option due to the greater versatility and mobility it can offer.

PAG's Response: No. The equipment indicated is approved as specified by the Federal Grantor

Question submitted by Morrico Equipment via e-mail on February 9, 2024

Question #1: Delivery Date a. IFB-PAG-004-24 Page 3 of 68 "Invitation for Bid": i. Required Delivery Date: (460 days ARO) upon receipt of purchase order. b. IFB-PAG-004-24 Page 48 of 68 "Deliver:" i. The successful bidder shall deliver one (1) 180' Boom Lift each be new fully assembled and ready for operation to the Port Authority of Guam within 120 days. Morrico requests the delivery date is confirmed at 460 day ARO due to advised manufacturing schedules.

PAG's Response: See Amendment #1

Rory J. Respicio  
General Manager

ORIGINAL

ACKNOWLEDGEMENT

NAME: Patrick Chargualaf

COMPANY: Morrigo Equipment LLC

DATE/TIME: 02/15/2024 @ 4:14 PM



**PORT OF GUAM**  
 ATURIDATI PUETTON GUAHAN  
**Jose D. Leon Guerrero Commercial Port**  
 1026 Cabras Highway, Suite 201, Piti, Guam 96915  
 Telephone: 671-477-5931/35 Facsimile: 671-477-2689/4445  
 Website: [www.portguam.com](http://www.portguam.com)



**Lourdes A. Leon Guerrero**  
 Governor of Guam  
**Joshua F. Tenorio**  
 Lieutenant Governor

**AMENDMENT NO. 1**

DATE: February 14, 2024

**INVITATION FOR BID No. PAG-004-24**  
**180' Telescopic Boom Lift**

**NOTICE TO OFFERORS:** The IFB documents of the above referenced project are hereby amended to include the following as part of IFB documents:

Amend to change on page 48 of 68 under deliver **TO READ FROM:** The successful bidder shall deliver one(1) 180' Boom Lift each be new fully assembled and ready for operation to the Port Authority of Guam within 120 days **TO NOW READ:** The successful bidder shall deliver one(1) 180' Boom Lift fully assembled and ready for operation to the Port Authority of Guam within 460 days.

**\*\*\* END OF AMENDMENT NO. 1, ALL OTHERS REMAIN THE SAME \*\*\***

Issued by:

Rory J. Respicio  
 General Manager

NAME OF OFFEROR: Morrice Equipment LLC

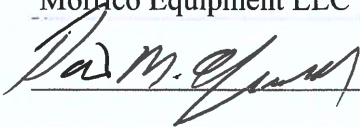
AUTHORIZED SIGNATURE: 

PRINT NAME: Patrick Chargualaf

DATE/ TIME: 02/15/2023 @ 4:12 PM

**ORIGINAL**

Re: Amendment No. 1 and Questions & Concerns IFB-PAG-004-24 180' Telescopic Boom Lift

Mark A. Cabrera <macabrera@portofguam.com>

Thu 2/15/2024 4:36 PM

To: Patrick Chargualaf <Patrick@morricequipment.com>

Cc: algsablan <algsablan@portofguam.com>; PAG Procurement <pagprocurement@portofguam.com>; Jesse Munoz <Jesse.Munoz@morricequipment.com>; Joel Lesh <Joel.Lesh@MorricoEquipment.com>

📎 1 attachments (14 KB)

logo.jpeg;

---

**This Message Is From an External Sender**

This message came from outside your organization.

Hello Patrick,

Received.

Thank You,

Mark A. Cabrera  
Procurement Buyer Supervisor

Port Authority of Guam  
1026 Cabras Highway  
Suite 201 Piti GU 96915  
(671)477-5931 ext. 252  
macabrera@portofguam.com

---

**From:** "Patrick Chargualaf" <Patrick@morricequipment.com>  
**To:** "Mark A. Cabrera" <macabrera@portofguam.com>, "algsablan" <algsablan@portofguam.com>, "PAG Procurement" <pagprocurement@portofguam.com>  
**Cc:** "Jesse Munoz" <Jesse.Munoz@morricequipment.com>, "Joel Lesh" <Joel.Lesh@MorricoEquipment.com>  
**Sent:** Thursday, February 15, 2024 4:33:54 PM  
**Subject:** Re: Amendment No. 1 and Questions & Concerns IFB-PAG-004-24 180' Telescopic Boom Lift

Mark,

ORIGINAL

Good afternoon.



Attached for review signed

- Amendment #1 and
- Q&C responses

From Morrigo Equipment.

Please confirm receipt and kindly reply with any questions or concerns.

**Patrick Mafnas Chargualaf**

Generator And Equipment Sales

Office: 671.649.1946

Mobile: 671.688.0309

This message and any attachments are intended only for the use of the addressee and may contain information that is privileged and confidential.

If the reader of the message is not the intended recipient or an authorized representative of the intended recipient, you are hereby notified

that any dissemination of this communication is strictly prohibited. If you have received this communication in error, please notify us immediately

by e-mail and delete the message and any attachments from your system.

---

**From:** Mark A. Cabrera <macabrera@portofguam.com>

**Sent:** Thursday, February 15, 2024 3:35 PM

**To:** algsablan <algsablan@portofguam.com>

**Cc:** PAG Procurement <pagprocurement@portofguam.com>

**Subject:** Amendment No. 1 and Questions & Concerns IFB-PAG-004-24 180' Telescopic Boom Lift

Hafa Adai All Bidders,

Please acknowledge by signing and returning each of the attachments.

Thank You,

Mark A. Cabrera

Procurement Buyer Supervisor

Port Authority of Guam

1026 Cabras Highway

Suite 201 Piti GU 96915

(671)477-5931 ext. 252

macabrera@portofguam.com

ORIGINAL



**DEPARTMENT OF REVENUE AND TAXATION**  
 GOVERNMENT OF GUAM  
 P.O. Box 23607  
 Barrigada, Guam 96921  
 www.guamtax.com

**BUSINESS LICENSE**

Serial# 2501589

R

Ltd Liability Company

Retail

**EXPIRES:** 1/31/2025

**ACCOUNT NO.** 30-200400017-001

**ISSUED TO:** MORRICO EQUIPMENT, L.L.C.

**DOING BUSINESS AS:** MORRICO EQUIPMENT, L.L.C.

**TYPE OF LICENSE:** SALE OF TRUCKS, FORKLIFTS, GENERATORS, & OTHER HEAVY EQUIPMENT & RELATED PARTS

**BUSINESS LOCATION:** LOT 2144-1B-R5-NEW1 & RW

TAMUNING GUAM

**MAILING ADDRESS:** 197 YPAO RD

TAMUNING GUAM

**TELEPHONE:** HOME 0

96913

**BUSINESS** 6491946

2/2/2024

<b>FEE</b>	1000.00
<b>PENALTY</b>	2.00
<b>TOTAL FEE</b>	1002.00

**PAID**

FEB 02 2024

Treasurer of Guam  
 #111

KEEP POSTED IN A CONSPICUOUS PLACE.  
 LICENSE MUST BE PRODUCED UPON DEMAND TO ANY AUTHORIZED GOV'T OFFICIAL.

*Marie P. Lizama*  
 Marie P. Lizama  
 ACTING DIRECTOR

ACTING DIRECTOR OF REVENUE AND TAXATION

ORIGINAL



**DEPARTMENT OF REVENUE AND TAXATION**  
 GOVERNMENT OF GUAM  
 P.O. Box 23607  
 Barrigada, Guam 96921  
 www.guamtax.com

**BUSINESS LICENSE**

Serial# 2501585

R

Ltd Liability Company

Service

**EXPIRES:** 1/31/2025

**ACCOUNT NO.** 13-200400017-001

**ISSUED TO:** MORRICO EQUIPMENT, L.L.C.

**DOING BUSINESS AS:** MORRICO EQUIPMENT, L.L.C.

**TYPE OF LICENSE:** REPAIR OF HEAVY EQUIPMENT

**BUSINESS LOCATION:** LOT 2144-1B-R5-NEW1 & RAW

TAMUNING GUAM

**MAILING ADDRESS:** 197 YPAO RD

TAMUNING GUAM

**TELEPHONE:** HOME 0

96913

**BUSINESS** 6481946

<b>FEE</b>	50 00
------------	-------

<b>PENALTY</b>	2 00
----------------	------

<b>TOTAL FEE</b>	52 00
------------------	-------

**PAID**

FEB 02 2024

Treasurer of Guam

#11

*Marie P. Lizama*  
 Marie P. Lizama  
 ACTING DIRECTOR

Marie P. Lizama

ACTING DIRECTOR OF REVENUE AND TAXATION

KEEP POSTED IN A CONSPICUOUS PLACE.  
 LICENSE MUST BE PRODUCED UPON DEMAND TO ANY AUTHORIZED GOV'T OFFICIAL.

ORIGINAL



DEPARTMENT OF REVENUE AND TAXATION

GOVERNMENT OF GUAM  
P.O. Box 23607  
Barrigada, Guam 96921  
www.guamtax.com

**BUSINESS LICENSE**

Serial# 2501588

R

Ltd Liability Company

Wholesale

EXPIRES: 1/31/2025

ACCOUNT NO. 20-200400017-001

ISSUED TO: MORRICO EQUIPMENT, L.L.C.

DOING BUSINESS AS: MORRICO EQUIPMENT, L.L.C.

TYPE OF LICENSE: WHOLESALE OF EQUIPMENT SPARE PARTS  
& RELATED ITEMS

BUSINESS LOCATION: LOT 2144-1B-R5-NEW1 & RW

TAMUNING GUAM

MAILING ADDRESS: 197 YPAO RD

TAMUNING GUAM

TELEPHONE: HOME 0

96913

BUSINESS 6481946

2/2/2024

FEE	800.00
PENALTY	2.00
<b>TOTAL FEE</b>	<b>802.00</b>

**PAID**

FEB 02 2024

Treasurer of Guam

#11

KEEP POSTED IN A CONSPICUOUS PLACE.  
LICENSE MUST BE PRODUCED UPON DEMAND TO ANY AUTHORIZED GOV'T OFFICIAL.

*Mario P. Lizama*  
Mario P. Lizama  
ACTING DIRECTOR

ACTING DIRECTOR OF REVENUE AND TAXATION

ORIGINAL



• EQUIPMENT •

Sales, Rental, Parts and Service

ADDRESS: 197 Ypao Road, Tamuning  
Guam 96913  
OFFICE: Phone: 1-671-649-1946  
FAX: 1-671-649-1947  
SPARE PARTS: Phone: 1-671-646-7914  
Fax: 1-671-646-7900  
WEB: www.morricequipment.com



TO: Mr. Rory J. Respicio  
General Manager  
Port Authority of Guam  
1026 Cabras Highway, Suite 201  
Piti, Guam 96915

CC: PAG Procurement  
Ms. Annie L.G. Sablan  
Inventory Management Administrator  
Mr. Mark A. Cabrera  
Buyer Supervisor

VIA: [rjrespicio@portofguam.com](mailto:rjrespicio@portofguam.com); [pagprocurement@portofguam.com](mailto:pagprocurement@portofguam.com);  
[algsablan@portofguam.com](mailto:algsablan@portofguam.com); [macabrera@portofguam.com](mailto:macabrera@portofguam.com)

DATE: 15 February 2024

FROM: Patrick Chargualaf / Jesse Munoz / Ross Morrison

PAGES: 1

RE: LETTER OF DEVIATION for IFB PAG-004-24 180' TELESCOPIC BOOM LIFT from MORRICO EQUIPMENT

Port Authority of Guam General Manager Mr. Respicio,

Hafa Adai.

Morrigo Equipment is submitting letter of deviation for IFB PAG-004-24 180' Telescopic Boom Lift regarding

- 1. Item 1.1 Telescopic Boom Lift, 180' Reach Full time 4WD
  - o Specifications:
    - Fuel Tank: The fuel tank furnished shall be Min 50. Gallon
- JLG 1850SJ proposed by Morrigo Equipment has 45 gallon fuel tank.

Please contact me at 649-1946 or 688-0309 if you have any questions.

Regards,

Patrick Chargualaf  
Generator and Equipment Sales  
Morrigo Equipment LLC

IFB PAG-004-24 180ft Telescopic Boom Lift\Deviation Letter IFB PAG-004-24 180 ft Telescopic Boom Lift dtd 15 Feb 2024

ORIGINAL

ON-SITE DIESEL DELIVERY



6a



**PORT OF GUAM**  
ATURIDAT I PUETTON GUAHAN  
Jose D. Leon Guerrero Commercial Port  
1026 Cabras Highway, Suite 201, Piti, Guam 96915  
Telephone: 671-477-5931/35 Facsimile: 671-477-2689/4445  
Website: [www.portguam.com](http://www.portguam.com)



Lourdes A. Leon Guerrero  
Governor of Guam  
Joshua F. Tenorio  
Lieutenant Governor

## NOTICE OF REJECTION OF BID

TO: Morrico, Equipment, LLC  
ADDRESS: 197 Ypao Road, Tamuning, GU 96913  
VIA EMAIL: Patrick@morricequipment.com  
FROM: Procurement Officer  
DATE: March 19, 2024  
RE: IFB-PAG-004-24 re: Procurement of 180' Telescopic Boom Lift  
SUBJECT: Notice of Rejection of Bid

Håfa Ådai Mr. Patrick M. Chargualaf,

The Port Authority of Guam ("PAG") finds that the bid submitted by Morrico Equipment, LLC ("Morrico") for IFB-PAG-004-24 exceeds the funding available for this IFB. It has been determined that rejection of the bid is required in the best interests of the government of Guam. Therefore, Morrico's bid is rejected pursuant to 2 GARR, Div. 4 § 3115(e).

It has been determined that need for the 180' Telescopic Boom Lift continues, and there is adequate time to resolicit in order to afford bidders time to respond to the re-solicitation. Therefore, it is determined that no award shall be made for this IFB, and it shall be cancelled pursuant to 2 GAR, Div. 4, § 3115(d)(2), in order to allow for re-solicitation. All registered prospective bidders and bidders shall be given notice and the opportunity to compete on the re-solicitation.

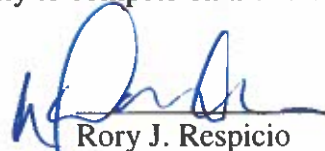
 3/20/24  
Rory J. Respicio  
General Manager/Procurement Officer,  
Port Authority of Guam



**PORT OF GUAM**  
ATURIDAT I PUETTON GUAHAN  
Jose D. Leon Guerrero Commercial Port  
1026 Cabras Highway, Suite 201, Piti, Guam 96915  
Telephone: 671-477-5931/35 Facsimile: 671-477-2689/4445  
Website: [www.portguam.com](http://www.portguam.com)



Lourdes A. Leon Guerrero  
Governor of Guam  
Joshua F. Tenorio  
Lieutenant Governor

Accountability \* Impartiality \* Competence \* Openness \* Value

## BID STATUS

March 19, 2024

Mr. Patrick M. Chargualaf  
Generator and Equipment Sales  
Morricco Equipment  
197 Ypao Road  
Tamuning, GU 96913  
Cellular: 671-688-0309  
Email: [patrick@morriccoequipment.com](mailto:patrick@morriccoequipment.com)

BID INVITATION NO.: IFB/PAG-004-24      OPENING DATE: February 16, 2024

180' Telescopic Boom Lift Invitation for Bid

The following is the result of the above-mentioned bid. Refer to the items checked below.

- [ ] Cancelled (in its entirety), or partially cancelled due to:
- ( ) Insufficient funds:
  - ( ) Change of specifications; or
  - ( ) Insufficient number of bidders.
- [ X ] Rejected due to:
- ( ) Late submission the of bid;
  - (X) High Price
  - ( ) Not meeting the delivery requirement as stated in the IFB
  - ( ) Non-conformance with the requirements of the IFB; See Remarks
  - ( ) Others:

**REMARKS:** The Port may issue a re-bid and will inform Morricco Equipment at such time.

  
\_\_\_\_\_  
RORY J. RESPICIO  
General Manager

Please Print  
Acknowledgement Copy  
Received by:  
Date:  
Company Name:  
Email To: [algsablan@portofguam.com](mailto:algsablan@portofguam.com), [macabrera@portofguam.com](mailto:macabrera@portofguam.com)



6b



**PORT OF GUAM**  
ATURIDAT I PUETTON GUAHAN  
**Jose D. Leon Guerrero Commercial Port**  
1026 Cabras Highway, Suite 201, Piti, Guam 96915  
Telephone: 671-477-5931/35 Facsimile: 671-477-2689/4445  
Website: [www.portguam.com](http://www.portguam.com)



**Lourdes A. Leon Guerrero**  
Governor of Guam  
**Joshua F. Tenorio**  
Lieutenant Governor

February 15, 2024

Mr. Reynold T. Leung  
VP Operations  
Surface Solutions  
928 Marine Corps Drive Suite 101,  
Tamuning GU 96913

RE: Request for 14-day extension of bid submission

Dear Mr. Leung:

We are in receipt of your letter dated February 15, 2024 in regards to extending the bid submittal for IFB-PAG-004-24 180' Telescopic Boom Lift. We appreciate your interest and efforts to submit a bid offer and understand that you may have some challenges in meeting our requirements. Unfortunately, we have other registered bidders whom have submitted questions and are prepared to submit a bid for this project. Timelines for these projects are highly critical in meeting the Port's objectives. Therefore, in the best interest of the Port and the territory we will have to deny your request.

We hope that you may still do your best to participate in this bid, or at least participate in Port's future bids and solicitations.

Respectfully,

  
**RORY J. RESPICIO**  
General Manager

7a

**SUBJECT TO RETURN, DUE TO POSSIBLE  
CONFLICT**

RECEIVED  
3:24 pm 03/02/24  
OFFICE OF THE ATTORNEY GENERAL  
CIVIL DIVISION  
*[Signature]*

**FOWLER & VISOSKY LLP  
ATTORNEYS AT LAW**

1026 CORPS DRIVE, SUITE 201  
HAGATNA, GUAM 96913  
PHONE: (671) 646-1222  
FAX: (671) 646-1223

www.guamlawoffice.com

Of Counsel:  
**MELINDA S. SWAVELY**

Writer's Direct Email:  
fowler@guamlawoffice.com

March 5, 2024

## **PROCUREMENT PROTEST**

### **VIA FACSIMILE TRANSMISSION and HAND DELIVERY**

Mark A. Cabrera  
Procurement Buyer Supervisor  
**PORT AUTHORITY OF GUAM**  
1026 Cabras Highway, Suite 201  
Piti Guam, 96915

**RE: IFB-PAG-004-24 180' Telescopic Boom Lift**

Dear Mr. Cabrera,

This office represents Morrigo Equipment, LLC ("Morrigo"), 197 Ypao Road, Tamuning, Guam 96913, with respect to IFB-PAG-004-24 180' Telescopic Boom Lift (the "IFB"). Morrigo hereby files its protest with respect to the IFB. The reasons for this protest are as follows.

The Port Authority of Guam ("PAG"), let the subject IFB. Morrigo was the only bidder for the IFB and presented the PAG with the lowest responsive bid. On or about February 20, 2024, the PAG inquired of Morrigo whether it would agree to lower the price of its bid to a number below that which Morrigo provided in its bid submission. After February 20, 2024, Morrigo advised PAG that it could not lower its bid. The PAG thereafter asked Morrigo whether it was sure it did not want to lower its price and Morrigo responded that it could not lower its price.

The Guam procurement code and the Guam procurement regulations do not contain provisions for the negotiations of bid price after bid opening on an IFB. *See, e.g.*, 5 GCA Section 5211(e) ("Bids shall be unconditionally accepted without alteration or correction."); 2 GAR Section 3109(n)(5) ("this Section does not permit negotiations with any bidder."). Accordingly, Morrigo could not by law negotiate the price of its bid after bid opening.

The PAG has not issued an award of the IFB to Morrigo despite Morrigo submitting the lowest responsive bid. As Morrigo submitted the lowest responsive bid for the IFB, the PAG was required to award the IFB to Morrigo. Accordingly, based on the foregoing, Morrigo respectfully requests that the PAG award it the subject IFB.

7b

ROBERTS FOWLER & VISOSKY LLP  
ATTORNEYS AT LAW

TIM ROBERTS  
KEVIN J. FOWLER  
JON A. VISOSKY  
SETH FORMAN

865 SOUTH MARINE CORPS DRIVE, SUITE 201  
TAMUNING, GUAM 96913  
TELEPHONE: (671) 646-1222  
FACSIMILE: (671) 646-1223  
www.guamlawoffice.com

Of Counsel:  
MELINDA S. SWAVELY

Writer's Direct Email:  
fowler@guamlawoffice.com

March 6, 2024

**AMENDED PROCUREMENT PROTEST**

**VIA FACSIMILE TRANSMISSION**  
**and HAND DELIVERY**

Rory J. Respicio  
General Manager  
**PORT AUTHORITY OF GUAM**  
1026 Cabras Highway, Suite 201  
Piti Guam, 96915

**RE: IFB-PAG-004-24 180' Telescopic Boom Lift**

Dear Mr. Respicio,

This office represents Morrico Equipment, LLC ("Morrico"), 197 Ypao Road, Tamuning, Guam 96913, with respect to IFB-PAG-004-24 180' Telescopic Boom Lift (the "IFB"). Morrico hereby files its protest with respect to the IFB. The reasons for this protest are as follows.

The Port Authority of Guam ("PAG"), let the subject IFB. Morrico was the only bidder for the IFB and presented the PAG with the lowest responsive bid. On or about February 20, 2024, the PAG inquired of Morrico whether it would agree to lower the price of its bid to a number below that which Morrico provided in its bid submission. After February 20, 2024, Morrico advised PAG that it could not lower its bid. The PAG thereafter asked Morrico whether it was sure it did not want to lower its price and Morrico responded that it could not lower its price.

The Guam procurement code and the Guam procurement regulations do not contain provisions for the negotiations of bid price after bid opening on an IFB. *See, e.g.,* 5 GCA Section 5211(e) ("Bids shall be unconditionally accepted without alteration or correction."); 2 GAR Section 3109(n)(5) ("this Section does not permit negotiations with any bidder."). Accordingly, Morrico could not by law negotiate the price of its bid after bid opening.

The PAG has not issued an award of the IFB to Morrico despite Morrico submitting the lowest responsive bid. As Morrico submitted the lowest responsive bid for the IFB, the PAG was required to award the IFB to Morrico. Accordingly, based on the foregoing, Morrico respectfully requests that the PAG award it the subject IFB.

Please be advised that pursuant to 5 G.C.A. § 5425, you are not to proceed further with the procurement or award of a procurement contract prior to resolution of this bid protest.

Sincerely,

ROBERTS FOWLER & VISOSKY, LLP



Kevin J. Fowler

7c





**PORT OF GUAM**  
ATURIDAT I PUETTON GUAHAN  
Jose D. Leon Guerrero Commercial Port  
1026 Cabras Highway, Suite 201, Piti, Guam 96915  
Telephone: 671-477-5931/35 Facsimile: 671-477-2689/4445  
Website: [www.portguam.com](http://www.portguam.com)



Lourdes A. Leon Guerrero  
Governor of Guam  
Joshua F. Tenorio  
Lieutenant Governor

### NOTICE OF CANCELLATION

**TO:** All Registered Potential Bidders who received an IFB package  
**FROM:** Procurement Officer  
**DATE:** March 19, 2024  
**RE:** IFB-PAG-004-24 re: Procurement of 180' Telescopic Boom Lift  
**SUBJECT:** Notice of Cancellation

Håfa Ådai,

Thank you for your interest in the IFB referenced above. Your company is receiving this notice because our records indicate that your company registered for a copy of IFB-PAG-004-24. Please be advised that it has been determined that in the best interests of Guam and all involved in this solicitation, IFB-PAG-004-24 is being cancelled. However, the government of Guam will re-solicit the services required for this project and you are invited to submit a bid when the new IFB is announced.

Sincerely,

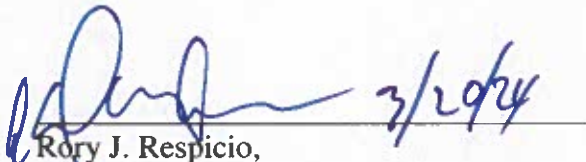
  
Rory J. Respicio,  
Procurement Officer/General Manager,  
Port Authority of Guam

ACKNOWLEDGEMENT	
COMPANY:	_____
NAME:	_____
DATE:	_____
TIME:	_____

7d



**PORT OF GUAM**  
ATURIDAT I PUEYTON GUAHAN  
Jose D. Leon Guerrero Commercial Port  
1026 Cabras Highway, Suite 201, Piti, Guam 96915  
Telephone: 671-477-5931/35 Facsimile: 671-477-2689/4445  
Website: [www.portguam.com](http://www.portguam.com)



Lourdes A. Leon Guerrero  
Governor of Guam  
Joshua F. Tenorio  
Lieutenant Governor

## DETERMINATION RE: REJECTION OF BID AND CANCELLATION

### MEMORANDUM

TO: Procurement Record  
FROM: Procurement Officer  
DATE: March 19, 2024  
RE: IFB-PAG-004-24 re: Procurement of 180' Telescopic Boom Lift  
SUBJECT: Determination Regarding Rejection of Bid and Cancellation

### STATEMENT OF FINDINGS:

The Port Authority of Guam ("PAG") finds that the bid submitted by Morrico Equipment, LLC ("Morrico") for IFB-PAG-004-24 exceeds the funding available for this IFB. It has been determined that rejection of the bid is required in the best interests of the government of Guam. Therefore, Morrico's bid is rejected pursuant to 2 GARR, Div. 4 § 3115(e).

It has been determined that need for the 180' Telescopic Boom Lift continues, and there is adequate time to resolicit in order to afford bidders time to respond to the re-solicitation. Therefore, it is determined that no award shall be made for this IFB, and it shall be cancelled pursuant to 2 GAR, Div. 4, § 3115(d)(2), in order to allow for re-solicitation. All registered prospective bidders and bidders shall be given notice and the opportunity to compete on the re-solicitation.

Rory J. Respicio  
General Manager/Procurement Officer,  
Port Authority of Guam

7e



**PORT OF GUAM**  
ATURIDAT I PUETTON GUAHAN  
Jose D. Leon Guerrero Commercial Port  
1026 Cabras Highway, Suite 201, Piti, Guam 96915  
Telephone: 671-477-5931/35 Facsimile: 671-477-2689/4445  
Website: [www.portguam.com](http://www.portguam.com)



Lourdes A. Leon Guerrero  
Governor of Guam  
Joshua F. Tenorio  
Lieutenant Governor

## **TRANSMITTAL**

March 21, 2024

**TO:** Honorable Douglas B. Moylan  
Attorney General of Guam  
Attn: Civil Division

**FROM:** Rory J. Respicio  
General Manager

**SUBJECT:** NOTICE OF CANCELLATION – **IFB/PAG-004-24** Procurement of 180' Telescopic Boom Lift

---

*Transmitted herewith is the following:*

- Notice of Cancellation

**PAG COPY**

**Acknowledgement Receipt:**

Name:	<u>Tillie Takao</u>
Date:	<u>3/21/24</u>
Time:	<u>12:30</u>

3/21  
**RECEIVED**  
OFFICE OF THE ATTORNEY GENERAL  
CIVIL DIVISION

8a











**PORT OF GUAM**  
 ATURIDATI PUETTON GUAHAN  
**Jose D. Leon Guerrero Commercial Port**  
 1026 Cabras Highway, Suite 201, Piti, Guam 96915  
 Telephone: 671-477-5931/35 Facsimile: 671-477-2689/4445  
 Website: [www.portguam.com](http://www.portguam.com)



*TAB 2+9*

**Lourdes A. Leon Guerrero**  
 Governor of Guam  
**Joshua F. Tenorio**  
 Lieutenant Governor

February 14, 2024

**INVITATION FOR BID IFB-PAG-004-24**  
**180' Telescopic Boom Lift**  
**Questions and Responses**

Question submitted by Far East Equipment via e-mail on January 30, 2024

**Question #1:** Would a boom truck with a working height of 182'11" be acceptable in lieu of a telescopic boom lift? We recommend this option due to the greater versatility and mobility it can offer.

**PAG's Response:** No. The equipment indicated is approved as specified by the Federal Grantor

Question submitted by Morrico Equipment via e-mail on February 9, 2024

**Question #1:** Delivery Date a. IFB-PAG-004-24 Page 3 of 68 "Invitation for Bid": i. Required Delivery Date: (460 days ARO) upon receipt of purchase order. b. IFB-PAG-004-24 Page 48 of 68 "Deliver:" i. The successful bidder shall deliver one (1) 180' Boom Lift each be new fully assembled and ready for operation to the Port Authority of Guam within 120 days. - Morrico requests the delivery date is confirmed at 460 day ARO due to advised manufacturing schedules.

**PAG's Response:** See Amendment #1

Rory J. Respicio  
 General Manager

<b>ACKNOWLEDGEMENT</b>
NAME: _____
COMPANY: _____
DATE/TIME: _____



**PORT OF GUAM**  
 ATURIDAT I PUETTON GUAHAN  
**Jose D. Leon Guerrero Commercial Port**  
 1026 Cabras Highway, Suite 201, Piti, Guam 96915  
 Telephone: 671-477-5931/35 Facsimile: 671-477-2689/4445  
 Website: [www.portguam.com](http://www.portguam.com)



**Lourdes A. Leon Guerrero**  
 Governor of Guam  
**Joshua F. Tenorio**  
 Lieutenant Governor

**AMENDMENT NO. 1**

DATE: February 14, 2024

**INVITATION FOR BID No. PAG-004-24**  
**180' Telescopic Boom Lift**

**NOTICE TO OFFERORS:** The IFB documents of the above referenced project are hereby amended to include the following as part of IFB documents:

Amend to change on page 48 of 68 under deliver **TO READ FROM:** The successful bidder shall deliver one(1) 180' Boom Lift each be new fully assembled and ready for operation to the Port Authority of Guam within 120 days **TO NOW READ:** The successful bidder shall deliver one(1) 180' Boom Lift fully assembled and ready for operation to the Port Authority of Guam within 460 days.

**\*\*\* END OF AMENDMENT NO. 1, ALL OTHERS REMAIN THE SAME \*\*\***

Issued by:

Rory J. Respicio  
 General Manager

NAME OF OFFEROR: \_\_\_\_\_

AUTHORIZED SIGNATURE: \_\_\_\_\_

PRINT NAME: \_\_\_\_\_

DATE/ TIME: \_\_\_\_\_

**RECEIVED** *mp 2/14/24*  
 General Manager's Office  
 Port Authority of Guam

<b>PROCUREMENT DIVISION</b>			FY24 ROUTING # <u>57</u>
Procurement Staff: <u>Mark</u>		Proc. Received Date:	
Date Out: <u>2/14/2024</u>	Time: <u>3:10pm</u>	Initial/Time: <u> / </u>	
Division	Initials	Date	Notes
Procurement Division	<i>AMS</i>	<u>2/14/2024</u>	<u>Amend 1 + Q&amp;C</u>
DGM - Admin & Finance	<i>pm</i>	<u>2/15/24</u>	
General Manager - (signature)			
SUBJECT: <u>1PB-PAG-004-24 180' Telescopic Boom Lift</u>			

URGENT

GM SIGNATURE

PLEASE RETURN TO PROCUREMENT

ITEM NO.	DESCRIPTION	QUANTITY	UNIT	UNIT PRICE	EXTENSION
1.1	Telescopic Boom Lift, 180' Reach Full time 4WD	1	EA.	\$ _____	\$ _____

**GENERALS:** These specifications have been written, to describe minimum equipment and performance requirements to be supplied by the equipment manufacture bidding. Reasonable test may be conducted upon delivery before acceptance.

The successful bidder shall furnish all necessary and desirable information and instructions for the proper operation of the equipment.

The government reserves the right to accept and/or reject any and all bids, to waive any defects, irregularities, or specification discrepancies and to award the bid as council deems to be in the best interest of the government.

**DISCREPANCIES**

**LISTED:** Should any bidder have deviations from these specifications in his bid and cannot meet every requirement of the specifications, he shall submit a letter and attach it to the bid, explaining the deviations, failure to do so will cause the bid to be rejected as being non-responsive.

**DELIVER:** The successful bidder shall deliver one (1) 180' Boom Lift each be new fully assembled and ready for operation to the Port Authority of Guam within 120 days.

**SPECIFICATIONS:**

**BIDDING AND OR REMARKS:**

<b>Engine:</b>	74 hp minimum, Diesel Engine Engine shutoff protection system (Low Oil Pressure, High Engine Temperature High Transmission Temperature)	_____
<b>Fuel Type:</b>	Diesel (Ultra Low Sulfur) Tier IV	_____
<b>Fuel Tank:</b>	The fuel tank furnished shall be Min. 50 gallon	_____
<b>Platform reach:</b>	180ft & 10ft jib	_____
<b>Platform Dimensions:</b>	36 x 96 with railing & side entry	_____
<b>Platform Capacity:</b>	Unrestricted - 500 lbs	_____
	Restricted - 750 lbs	_____
<b>Platform Rotation:</b>	160 degrees	_____
<b>Swing:</b>	360 degrees continuous	_____
<b>Steering:</b>	Selectable Steering (ground level or platform)	_____
<b>Axles:</b>	Extendable front and rear	_____
<b>Gauges:</b>	Air, Fuel, Hour, Volt, Temp, and Oil	_____
<b>Lights:</b>	2 Headlights in facing forward with protective guard, 2 Headlights facing rear with protective guard 2 work lights on platform	_____
<b>Tires:</b>	Protector Lug Foam Filled tires	_____
<b>Manlift Accessories:</b>	Platform to be plumbed with air lines for use of pneumatic Tools	_____
	Hostile Weather/Environment Kit	_____
	AC plug/outlet in platform	_____

**RE: Q&C for IFB-PAG-004-24 180' Telescopic Boom Lift**

**From :** Shine A. San Agustin <सानागुस्तिन@पोर्टऑफगुआम.कॉम> Tue, Feb 13, 2024 03:30 PM  
**Subject :** RE: Q&C for IFB-PAG-004-24 180' Telescopic Boom Lift 3 attachments  
**To :** algsablan <अल्सब्लान@पोर्टऑफगुआम.कॉम>  
**Cc :** Joaquin P. Pangelinan <ज्वाकिनप.पंगेलिनान@पोर्टऑफगुआम.कॉम>, Mark A. Cabrera <मार्क.ए.कैब्रेरा@पोर्टऑफगुआम.कॉम>, Christopher J. Aguon <क्रिस्टोफर.जे.आगुऑन@पोर्टऑफगुआम.कॉम>, Raymond B. Santos <रैमोन्ड.बी.सैंटोस@पोर्टऑफगुआम.कॉम>

Sorry for the late response.

- 1) Boom Truck will not be acceptable
- 2) 460 days for delivery will suffice

Thank you

v/r,



**Shine A. San Agustin**  
**Manager, Equipment Support Services**  
Port Authority of Guam  
1026 Cabras Highway, Ste. 201  
Piti, Guam 96925  
Tel: (671) 477-5931 EXT 401  
Email: [सानागुस्तिन@पोर्टऑफगुआम.कॉम](mailto:सानागुस्तिन@पोर्टऑफगुआम.कॉम)

\*\*\*\* CONFIDENTIALITY NOTICE \*\*\*\* For Official Use Only.

The information contained in this e-mail and any accompanying attachments may contain sensitive information, which is protected from mandatory disclosure under the Freedom of Information Act (FOIA), 5USC 522. It should not be released to unauthorized persons. If you are not the intended recipient of this information, any disclosure, copying, distribution, or the taking of any action in reliance on this information is prohibited. Classification: UNCLASSIFIED Caveats: FOUO

---

**From:** Joaquin P. Pangelinan <jppangelinan@portofguam.com>  
**Sent:** Tuesday, February 13, 2024 11:35 AM  
**To:** Shine A. San Agustin <sasanagustin@portofguam.com>  
**Subject:** Re: Q&C for IFB-PAG-004-24 180' Telescopic Boom Lift

Sir,  
My thoughts on questions  
1) `Boom Truck will not be acceptable  
2) 460 days for delivery  
let me know what you think.  
Kin

---

**From:** "Shine A. San Agustin" <sasanagustin@portofguam.com>  
**To:** "Raymond B. Santos" <rbsantos@portofguam.com>, "Mark A. Cabrera" <macabrera@portofguam.com>, "Joaquin Pangelinan" <jppangelinan@portofguam.com>  
**Cc:** "Christopher J. Aguon" <cjaguon@portofguam.com>, "Annie Sablan" <algsablan@portofguam.com>  
**Sent:** Tuesday, February 13, 2024 11:22:31 AM  
**Subject:** RE: Q&C for IFB-PAG-004-24 180' Telescopic Boom Lift

We will sir give us some time other issues in the work as well

Thank you



**Shine A. San Agustin**  
**Manager, Equipment Support Services**  
Port Authority of Guam  
1026 Cabras Highway, Ste. 201  
Piti, Guam 96925  
Tel: (671) 477-5931 EXT 401  
Email: [sasanagustin@portofguam.com](mailto:sasanagustin@portofguam.com)

\*\*\*\* CONFIDENTIALITY NOTICE \*\*\*\* For Official Use Only.

The information contained in this e-mail and any accompanying attachments may contain sensitive information, which is protected from mandatory disclosure under the Freedom of Information Act (FOIA), 5USC 522. It should not be released to unauthorized persons. If you are not the intended recipient of this information, any disclosure, copying, distribution, or the taking of any action in reliance on this information is prohibited. Classification: UNCLASSIFIED Caveats: FOUO

---

**From:** Raymond B. Santos <rbsantos@portofguam.com>  
**Sent:** Tuesday, February 13, 2024 11:21 AM

**To:** Mark A. Cabrera <[macabrera@portofguam.com](mailto:macabrera@portofguam.com)>; Shine A. Agustin <[sasanagustin@portofguam.com](mailto:sasanagustin@portofguam.com)>; Joaquin P. Pangelinan <[jppangelinan@portofguam.com](mailto:jppangelinan@portofguam.com)>  
**Cc:** Christopher J. Aguon <[cjaguon@portofguam.com](mailto:cjaguon@portofguam.com)>; algsablan <[algsablan@portofguam.com](mailto:algsablan@portofguam.com)>  
**Subject:** Re: Q&C for IFB-PAG-004-24 180' Telescopic Boom Lift

Kin and Shine,  
Could you respond to the questions from the vendor.

Thanks,  
Ray

---

**From:** Mark <[macabrera@portofguam.com](mailto:macabrera@portofguam.com)>  
**To:** Raymond <[rbsantos@portofguam.com](mailto:rbsantos@portofguam.com)>; Shine <[sasanagustin@portofguam.com](mailto:sasanagustin@portofguam.com)>; Joaquin <[jppangelinan@portofguam.com](mailto:jppangelinan@portofguam.com)>  
**Cc:** Christopher <[cjaguon@portofguam.com](mailto:cjaguon@portofguam.com)>; algsablan <[algsablan@portofguam.com](mailto:algsablan@portofguam.com)>  
**Date:** Monday, 12 February 2024 1:58 PM ChST  
**Subject:** Q&C for IFB-PAG-004-24 180' Telescopic Boom Lift

Hafa Adai Ray/Shine/ and Kin-

Below are the questions received for IFB-PAG-004-24 180' Telescopic Boom Lift. Procurement needs responses.

1. Would a boom truck with a working height of 182' 11" be acceptable in lieu of a telescopic boom lift? we recommend this option due to the greater versatility and mobility it can offer.
2. Required delivery indicated on the bid page 3 of 68 is (460) days. On page 48 of 68 delivery reads 120 days. Bidder request to confirm that 460 days ARO is the correct delivery.

As for the 2nd question, based on the market research, 15 months may be required for delivery on a build to order by the manufacturer. Please provide procurement with response no later than tomorrow 2/13/2024.

Respectfully,

Mark A. Cabrera  
Procurement Buyer Supervisor



Port Authority of Guam  
1026 Cabras Highway  
Suite 201 Piti GU 96915  
(671)477-5931 ext. 252  
[macabrera@portofguam.com](mailto:macabrera@portofguam.com)





100



---



**PORT OF GUAM**  
ATURIDAT I PUEITON GUAHAN  
Jose D. Leon Guerrero Commercial Port  
1026 Cabras Highway, Suite 201, Piti, Guam 96915  
Telephone: 671-477-5931/35 Facsimile: 671-477-2689/4445  
Website: [www.portguam.com](http://www.portguam.com)



TAB 819

Lourdes A. Leon Guerrero  
Governor of Guam  
Joshua F. Tenorio  
Lieutenant Governor

February 15, 2024

Mr. Reynold T. Leung  
VP Operations  
Surface Solutions  
928 Marine Corps Drive Suite 101,  
Tamuning GU 96913

RE: Request for 14-day extension of bid submission

Dear Mr. Leung:

We are in receipt of your letter dated February 15, 2024 in regards to extending the bid submittal for IFB-PAG-004-24 180' Telescopic Boom Lift. We appreciate your interest and efforts to submit a bid offer and understand that you may have some challenges in meeting our requirements. Unfortunately, we have other registered bidders whom have submitted questions and are prepared to submit a bid for this project. Timelines for these projects are highly critical in meeting the Port's objectives. Therefore, in the best interest of the Port and the territory we will have to deny your request.

We hope that you may still do your best to participate in this bid, or at least participate in Port's future bids and solicitations.

Respectfully,

  
RORY J. RESPICIO  
General Manager



**A SPECIALTY CONSTRUCTION COMPANY**

February 15, 2024

**TO:** Port of Guam  
1<sup>st</sup> Floor , PAG Admin Bldg.

**ATTN:** Mr. Mark Cabrera  
Procurement Office

**PROJECT:** IFB PAG-004-24  
180' Telescopic Boom Lift

**SUBJECT:** Request for the extension of due date of bid submission by at least 14 days

Dear Sir Mark Cabrera,

We hereby respectfully request for a 14 days' time extension for the submission of bid due to we are still waiting for the proposal from our vendors and our insurance for bonding is also requesting for additional time in processing our bid bond request.

We look forward to your kind consideration.

Sincerely:

A handwritten signature in blue ink, appearing to be "R. Leung", is written over a horizontal line.

REYNOLD T. LEUNG  
VP OPERATIONS / SURFACE SOLUTIONS

928 N Marine Corps Drive Suite 101, Tamuning GU 96913  
◆ 671-898-1741 ◆ Email [surfacesolutionspacific@gmail.com](mailto:surfacesolutionspacific@gmail.com)

PROCUREMENT DIVISION			FY24 ROUTING # <u>58</u>
Procurement Staff: <u>Mark</u>		Proc. Received Date: _____	
Date Out: <u>2/15/2024</u>	Time: <u>3:00 pm</u>		Initial/Time: _____
Division	Initials	Date	Notes
Procurement Division	<u>me MW</u>	<u>2/15/24</u>	<u>Response to extension request.</u>
DGM - Admin & Finance			
General Manager - (signature)	<u>[Signature]</u>	<u>2/15/24</u>	
SUBJECT: <u>IFB-PAG-004-24 180' Telescopic Boom Lift</u> <u>Letter to Surface Solutions</u>			
<input type="checkbox"/> URGENT			<input type="checkbox"/> GM SIGNATURE
<input checked="" type="checkbox"/> PLEASE RETURN TO PROCUREMENT			

**RECEIVED**  
 General Manager's Office  
 Port Authority of Guam  
*2/15/24*

---

**Documents requiring preparation for Bid Rejection and Cancellation of IFB**

---

**From :** Jessica L. Toft <jtoft@portofguam.com>

Fri, Mar 15, 2024 04:39 PM

**Subject :** Documents requiring preparation for Bid Rejection and Cancellation of IFB 4 attachments**To :** Mark A. Cabrera <macabrera@portofguam.com>

Hi Mark,

In addition to the rejection of bid (GSA) form that you are preparing, please prepare these three documents for finalization and signature:

- 1) Written Determination for Rejection and Cancellation (to be placed in the Record behind Tab 21)
- 2) Notice of Rejection of Bid for Morrico (to be sent to Morrico and copy placed in the record behind Tab 18)
- 3) Notice of Cancellation (to be sent to all registered prospective bidders, including Morrico, and copy placed behind Tab 18)

Sincerely,



Jessica Toft  
Port Staff Attorney  
Port Authority of Guam  
1026 Cabras Highway, Ste. 201  
Piti, Guam 96925  
Tel: (671) 472-1054  
Fax: (671) 477-4445  
Email: jtoft@portofguam.com  
Website: www.portofguam.com

**\*\*\* CONFIDENTIALITY NOTICE \*\*\*\***

This email and any files transmitted with it are confidential and intended solely for the use of the individual or entity to whom they are addressed. If you have received this email in error, please notify the system manager. This message contains confidential information and is intended only for the individual named. If you are not the named addressee you should not disseminate, distribute or copy this e-mail. Please notify the sender immediately by e-mail if you have received this e-mail by mistake and delete this e-mail from your system. If you are not the intended recipient you are notified that disclosing, copying, distributing or taking any action in reliance on the contents of this information is strictly prohibited.

---

 **Letter (Notice) of Rejection of Bid to Morrico.docx**  
19 KB

 **Letter (Notice) of Cancellation.docx**  
19 KB

**Determination of Rejection of Bid and Cancellation.docx**  
19 KB

---

---

**Word Document Telescopic Boom Lift req#21658-ON**

---

**From :** Jacqueline A. Cruz <jcruz@portofguam.com>  
**Subject :** Word Document Telescopic Boom Lift req#21658-ON  
**To :** PAG Procurement <pagprocurement@portofguam.com>  
**Cc :** Raymond B. Santos <rbsantos@portofguam.com>,  
Estefanie C. Cordero <eccordero@portofguam.com>,  
Kevin R. Sanchez <krsanchez@portofguam.com>,  
Joaquin P. Pangelinan <jppangelinan@portofguam.com>

Mon, Oct 23, 2023 04:06 PM

 2 attachments

Hafa Adai!

Please see attached document:

Word Document Bid Specs for Telescopic Boom Lift

Be advised documents are routing for signatures.

*Jacqueline A Cruz*

Program Coordinator II | Transportation Division  
Port Authority of Guam  
1026 Cabras Highway, Suite #201  
Piti, Guam 96915  
(671) 477-5931 extension 295

---

*Jacqueline A Cruz*

**name1.png**  
4 KB

 **180 boom lift specs (3).docx**  
21 KB

---



---

**Boom Lift Specs**

---

**From :** Joaquin P. Pangelinan <jppangelinan@portofguam.com> Wed, Oct 18, 2023 03:00 PM  
**Subject :** Boom Lift Specs  1 attachment  
**To :** Raymond B. Santos <rbsantos@portofguam.com>  
**Cc :** Shine A. San Agustin <sasanagustin@portofguam.com>, Christopher J. Aguon <cjaguon@portofguam.com>, Mark A. Cabrera <macabrera@portofguam.com>

Ray,  
Please review and forward Boom Lift Bid Spec's to Public Works for Approval and Signature,

Respectfully  
Joaquin P. Pangelinan  
Manager Equipment Support Services  
Maintenance Department  
Port Authority of Guam  
1026 Cabras Highway, Ste. 201 Piti, GU 96925  
Phone (671)477-5931 ex. 223  
jppangelinan@portofguam.com

---

 **180 boom lift specs.docx**  
20 KB

---



**Market Survey**

---

**From :** Joaquin P. Pangelinan <jppangelinan@portofguam.com> Mon, Sep 18, 2023 01:21 PM  
**Subject :** Market Survey  1 attachment  
**To :** Mark A. Cabrera <macabrera@portofguam.com>  
**Cc :** Evelyn G. Pangelinan <egpangelinan@portofguam.com>

Mark,  
Please review Telescopic Boom Lift Market Survey.

Respectfully  
Joaquin P. Pangelinan  
Manager Equipment Support Services  
Maintenance Department  
Port Authority of Guam  
1026 Cabras Highway, Ste. 201 Piti, GU 96925  
Phone (671)477-5931 ex. 223  
jppangelinan@portofguam.com

---

 **Market Survey; 180 Boom Lift.docx**  
246 KB

---

Zimbra

macabrera@portofguam.com

---

**Tenda Availability 180 Boom Lift Bid**

---

**From :** Denise <djcalvo@portofguam.com>

Mon, Nov 06, 2023 04:16 PM

**Subject :** Tenda Availability 180 Boom Lift Bid

 1 attachment

**To :** 'Raymond Bamba'  
<Raymond.Bamba@gsadoa.guam.gov>

**Cc :** 'PAG Procurement' <pagprocurement@portofguam.com>

H Hi Mr. Ray,

I hope all is well. Please let me know if the attached bid line items are available in Tenda.

Please see the file attached.

If you have any questions, please let me know.

Thank you,

Denise

---

 **180 boom lift specs (3).docx**  
21 KB

---



**PORT OF GUAM**  
ATURIDAT I PUETTON GUAHAN  
**Jose D. Leon Guerrero Commercial Port**  
1026 Cabras Highway, Suite 201, Piti, Guam 96915  
Telephone: 671-477-5931/35 Facsimile: 671-477-2689/4445  
Website: [www.portguam.com](http://www.portguam.com)



**Lourdes A. Leon Guerrero**  
Governor of Guam  
**Joshua F. Tenorio**  
Lieutenant Governor

November 22, 2023

The Honorable Douglas B. Moylan  
Attorney General of Guam  
Attn: Civil Division  
Office of the Attorney General of Guam  
590 S. Marine Corps Dr., Suite 901  
Tamuning, Guam 96913

Re: Notification of Solicitation for Project Number-IFB-PAG-004-24  
(Acquisition of 180' Telescopic Boom Lift)

---

Hafa Adai Attorney General Moylan,

This letter is to inform you that the Port Authority of Guam ("PAG") is currently ready to begin the solicitation for this acquisition. Therefore, the PAG hereby provides this formal notification. Should you have any questions, or should you like to request any documents, please contact this office.

Respectfully,

*Signed Copy delivered to A.G.*

**RORY J. RESPICIO**  
General Manager



**PORT OF GUAM**  
ATURIDATI PUETTON GUAHAN  
Jose D. Leon Guerrero Commercial Port  
1026 Cabras Highway, Suite 201, Piti, Guam 96915  
Telephone: 671-477-5931/35 Facsimile: 671-477-2689/4445  
Website: [www.portguam.com](http://www.portguam.com)



Lourdes A. Leon Guerrero  
Governor of Guam  
Joshua F. Tenorio  
Lieutenant Governor

November 22, 2023

The Honorable Douglas B. Moylan  
Attorney General of Guam  
Attn: Civil Division  
Office of the Attorney General of Guam  
590 S. Marine Corps Dr., Suite 901  
Tamuning, Guam 96913

Re: Notification of Procurement Over \$500,000 for Project Number-IFB/PAG-004-24  
(Acquisition of 180' Telescopic Boom Lift)

---

Hafa Adai Attorney General Moylan,

This letter is to inform you that the Port of Guam ("PAG") has initiated a procurement, Project Number IFB-PAG-004-24, and has estimated the total cost of acquisition to exceed \$500,000.00. Thus, pursuant to 5 GCA § 5150, the Port hereby makes this formal notification for the above-referenced procurement to the Office of the Attorney General ("OAG").

The purpose of this procurement is to acquire a new 180' Telescopic Boom Lift to replace the PAG's current Boom Lift.

The cost of this acquisition is currently estimated at \$655,500.00 and will be grant-funded by the MARAD FY 2022 American Marine Highway (AMH) Grant# 693JF72340007. Therefore, the Uniform Requirements of 2 CFR Part 200 and 5 GCA § 5004(b) apply to this procurement.

The PAG is currently ready to begin the first phase of this acquisition. Therefore, the PAG hereby provides this formal notification of the procurement, along with the submission of AG Form 014. Should you have any questions, or should you like to request any documents, please contact this office.

Respectfully,

*Signed copy delivered to A.G.*

RORY J. RESPICIO  
General Manager

Enclosure: AG Form 014

**Project Title: IFB-PAG-004-024 180 Telescopic Boom Lift**

<u>Item/ Phase</u>	<u>Description</u>	<u>Date</u>	<u>Day</u>	<u>Time</u>
<b>Bid Submittal Target</b>	Sealed Packet w/ all required documents	February 16, 2024	Friday	2:00 PM
<b>RFI Deadline</b>	Final receipt of questions for Port's response	February 9, 2024	Friday	5:00 PM
<b>Publication Date</b>	Date the Ad is published, at least 2 days prior to publish	Jan 26, 2024 <del>February 1, 2024</del>	Friday <del>Thursday</del>	
<b>Ad Block Review</b>	Reviewed by Upper Management	24 <del>January 30, 2024</del>	<del>Tuesday</del>	
<b>PUC Review</b>	N/A			
<b>SAAG Review</b>	Yes, Notice of Procurement			
<b>Board Review</b>	N/A			



**PORT OF GUAM**  
 ATURIDAT I PUETTON GUAHAN  
 Jose D. Leon Guerrero Commercial Port  
 1026 Cabras Highway, Suite 201, Piti, Guam 96915  
 Telephone: 671-477-5931/35 Facsimile: 671-477-2689/4445  
 Website: www.portguam.com



Lourdes A. Leon Guerrero  
 Governor of Guam  
 Joshua F. Tenorio  
 Lieutenant Governor

**RECEIVED**  
 General Manager's Office  
 Port Authority of Guam  
 Port Of Guam  
 Jose D. Leon Guerrero Commercial Port

OCT 25 2023  
 Received  
 Procurement and Supply Division

October 24, 2023

**INTER-OFFICE MEMORANDUM**

**TO:** General Manager  
**Via:** Procurement & Supply Manager  
**From:** Program Coordinator II  
**Subject:** **180' Telescopic Boom Lift**

*for AG Subl  
 Amante*

Transmitted for your review are the following documents for the procurement of a telescopic boom lift:

1. Requisition #21658 ON
2. Determination of Need
3. Transmittal of Planning Procurement Record to PAG Procurement
4. AG Form 014 – Declaration Re Compliance with 5 GCA § 5150
5. Market Research Survey
6. Scope of Services (signed by End-User/Division Head)
7. Scope of Services Soft Copy e-mailed to Procurement
8. Advertisement BPA PDN or Daily Post (Procurement)
9. Communication Log (Includes email copies or any other correspondence record)

Thank you in advance for your continued support in our efforts to secure the procurement of much needed E1 Technician Consultant.

Should you have any questions or need more information, please feel free to contact me.

*Si Yu'as Ma'ase*  
  
 Jacqueline Cruz

[ / ] Concur:

*Rory J. Respicio*

Rory J. Respicio



R43500

Port Authority of Guam  
Purchase Order Print

06/04/2024

Page - 1

Order Company 00050

Order Number 21658 000 ON

Shipped From Port Authority of Guam  
1026 Cabras Highway  
Piti GU 96925

Ship To Port Authority of Guam  
1026 Cabras Hywy, Ste 201  
Piti GU

Branch/Plant PAG01

Ordered 10/23/2023 Freight  
Requested 10/23/2023 Order Taken By Currency Code  
Delivery URGENTLY NEED

Line	Rev	Description /Supplier Item	Ordered	UOM	Unit Price	PU UM	Extended Price	Request Date	Order No	Ty
1.000	0	TELESCOPIC BOOM LIFT	1	EA	655,500.0000	EA	655,500.00	10/23/2023		

TELESCOPIC BOOM LIFT, 180' REACH FULL TIME 4WD

PLEASE SEE ATTACHED BID SPECIFICATIONS AND OTHER DOCUMENTS.

POC:JACQUE CRUZ, RAYMOND SANTOS (671)477-5931/5 EXTENSIONS 295 OR 294.

Total Order 655,500.00

Total Order

Term	Net Due - 30 Days	Tax Rate	*NA*	.00	655,500.00
------	-------------------	----------	------	-----	------------

**Reqs.Awaiting Approval -  
Work With Approval Status Summary**

Personal Form: (No Personalization) Layout: (No Layout) Query: All Records

Tools One View

Order Number 21658 ON 00050

Records 1 - 7

	 Approval Route Code	Person Responsible	Status	Released Date	Released Time
<input checked="" type="radio"/>	PAG10	<b>Budget Approver</b>	Approved	10/23/2023	145506
<input type="radio"/>	PAG10	SANTOS, RAYMOND B.	Approved	10/23/2023	152325
<input type="radio"/>	PAG10	NELSON, GLENN B.	Approved	10/23/2023	152430
<input type="radio"/>	PAG10	BAMBA, VINCENT C.	Approved	10/23/2023	152709
<input type="radio"/>	PAG10	PAG Buyer Supervisor	Approved	10/24/2023	83548
<input type="radio"/>	PAG10	PAG Buyer Manager	Approved	10/24/2023	110047
<input type="radio"/>	PAG10	RESPICIO, RORY J.	Approved	10/24/2023	141318



## TRANSMITTAL OF PLANNING PROCUREMENT RECORD TO GSA

**Instructions:** After ascertaining the statement's accuracy and truthfulness, the agency's (director or head of agency) must sign the Certification below to indicate that the agency has kept and will keep a complete procurement record of all documents required by law as to its planning of the procurement; and is in fact transmitting a full and complete record of the planning of the procurement to GSA in accompaniment with this transmittal form as of the date this form is signed.

**Requesting/Using Agency:** Port Authority of Guam

**Re:** Telescopic Boom Lift, 180' feet Reach Full time 4WD

### 5 GCA §5249 Record of Procurement Actions

Each procurement officer shall maintain a complete record of each procurement. The record shall include the following:

- (a) the date, time, subject matter and names of participants at any meeting including government employees that is in any way related to a particular procurement;
- (b) a log of all communications between government employees and any member of the public, potential bidder, vendor or manufacturer which is in any way related to the procurement;
- (c) sound recordings of all pre-bid conferences; negotiations arising from a request for proposals and discussions with vendors concerning small purchase procurement;
- (d) brochures and submittals of potential vendors, manufacturers or contractors, and all drafts, signed and dated by the draftsman, and other papers or materials used in the development of specifications; and
- (e) the requesting agency's determination of need.

### 5 GCA §5132. Retention of Electronic Mail Correspondences

All incoming and outgoing electronic mail (email) correspondences pertaining to matters related to the procurement of goods and services as governed by this Chapter shall be retained for a period of not less than five (5) years. Such electronic mail (email) correspondences may be used for evidentiary purposes in the appellate procedures contained in this Chapter.

### 5 GCA § 10102 (d). Definition of Public Records

Public Records includes any writing containing information relating to the conduct of public business prepared, owned, used, or retained by any state or local agency in any format, including in electronic format.

The specifications for this procurement were prepared by Joaquin P. Pangelinan in keeping with the above and all applicable Guam Procurement Laws and Regulations; and, he/she/they have included all records, meeting notes and any other materials in their/its possession in developing the specifications/statement of work/scope of services/technical specification as well as any of the above procurement records items. Additionally included is the written determination of need of the need the agency for this procurement (signed by director or head or the agency) and if applicable the board or commission minutes of the approval of this procurement. Please include research as to the availability of services, market availability. In the event this procurement is funded in whole or in part with federal funds a copy of the notice of grant award and any required federal terms and conditions or forms.

**CERTIFICATION:** I hereby certify under penalty of perjury that I am responsible for the planning procurement record and I have caused to be prepared and now transmit a full and complete record of the planning procurement records as required by law. I have obtained the signed verification of all individuals involved as the preparation of the specification that this is a true and accurate statement, and that this transmittal to GSA is complete. I acknowledge that there are continuing responsibilities within the requesting/using agency as to public records related to this procurement and will make sure they are maintained as required above.

Signature: 

Print Name: Joaquin P. Pangelinan

Date: Oct 24, 23

**DECLARATION RE COMPLIANCE WITH 5 GCA § 5150**

I, RORY J. RESPICIO, make this declaration on 10/23/2023  
*[print name clearly]* *[enter today's date]*  
regarding Procurement No. REQ#: 21658-ON, and do hereby **certify under penalty of perjury** that:  
*[enter procurement no.]*

(1) I am the procurement officer (Chief Procurement Officer; Director of Public Works; or head of a purchasing agency) for this procurement;

(2) I have caused an estimate to be made of the cost of the services or supplies being procured, and for which a contract will be entered into or a purchase order will be issued, whichever is appropriate as the case may be;

(3) My estimate of the total cost of the contract or purchase order, whichever is appropriate as the case may be, is *[please check one]*:

less than \$500,000; or

\$500,000 or more;

(4) If the total estimated cost of the procurement is \$500,000 or more, I understand that I must be advised by legal counsel designated by the Attorney General (which may be an Assistant Attorney General or other legal counsel designated as Special Assistant Attorney General ("SAAG") under 5 GCA § 5150) during each and every phase of the procurement process, beginning with the planning stage and before any request for proposal or invitation to bid is issued or notice published, or before any sole source procurement or emergency procurement is undertaken;

(5) If the total estimated cost of the procurement is \$500,000 or more, I understand I may not proceed with any phase of the procurement unless I have been advised by an Assistant Attorney General or a SAAG to proceed;

(6) If the total estimated cost of the procurement is less than \$500,000 initially when the procurement is begun, but the total cost increases to \$500,000 or more at some later point in time, I understand I must contact the Attorney General's Office as soon as I become aware that the procurement will actually cost \$500,000 or more, and that I may not proceed further without the assistance of the Attorney General's Office or a SAAG; and

(7) I understand if I do not comply with the requirements of 5 GCA § 5150 and the Attorney General's Office or a SAAG has not acted as legal counsel during all phases of a procurement estimated to cost \$500,000 or more, the Attorney General or SAAG may disapprove the contract, or the procurement may be subject to cancellation, or any award, contract or purchase order made or entered into may be subject to termination.

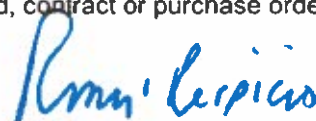

RORY J. RESPICIO

*[Declarant's Signature]*

## **180' Boom Lift Activity log**

September 18, 23 – Sent Mark Market Survey for approval

- Sent Ray Bamba email checking if GSA had any 180' Boom Lift available

September 19, 23 – Sent out Market Survey to

- Hawthorne
- Morrigo
- Far east
- LMS

September 26, - follow up calls to

- Morrigo
- Hawthorne
- LMS

October 2, followed up calls to

- Hawthorne
- Received Morrigo Market Survey

October 3, 23

- received response from Hawthorne
- received Morrigo BABAA document

October 5, 23 – received Morico Estimated cost

October 12, 23 – received LMS market Survey

October 20, 23 – received Signed Specifications from DPW

Zimbra

jppangelinan@portofguam.com

---

**180' Boom Lift Survey**

---

**From :** Joaquin P. Pangelinan  
<jppangelinan@portofguam.com>

Mon, Sep 18, 2023 02:44 PM

**Subject :** 180' Boom Lift Survey

**To :** Raymond Bamba <raymond.bamba@gsa.guam.gov>

**Cc :** Evelyn G. Pangelinan  
<egpangelinan@portofguam.com>

Good Afternoon Ray,  
Researching/Sourcing for a New 180' Boom Lift, does GSA have such equipment in stock?

Respectfully  
Joaquin P. Pangelinan  
Manager Equipment Support Services  
Maintenance Department  
Port Authority of Guam  
1026 Cabras Highway, Ste. 201 Piti, GU 96925  
Phone (671)477-5931 ex. 223  
jppangelinan@portofguam.com

---

Zimbra

jppangelinan@portofguam.com

---

**Re: Boom Lift Market Survey**

---

**From :** Patrick Chargualaf <Patrick@morricoequipment.com> Thu, Oct 05, 2023 08:05 AM  
**Subject :** Re: Boom Lift Market Survey   
**To :** Joaquin P. Pangelinan <jppangelinan@portofguam.com>  6 attachments  
**Cc :** Ross Morrison <Ross@morricoequipment.com>, Jesse Munoz <Jesse.Munoz@morricoequipment.com>

On Market Survey, page 8, cost \$ 640,500.00

Regards,

Patrick Mafnas Chargualaf  
Generator and Equipment Sales  
Morrico Equipment

+1 (671) 649-1946 Office  
+1 (671) 649-1947 Fax  
+1 (671) 688-0309 Cell



<http://www.morricoequipment.com>

**IMPORTANT:** The sender intends that this electronic message is for exclusive use by the person to whom it is addressed. This message may contain information that is confidential or privileged and exempt from disclosure under applicable law. If the reader of this message is not an intended recipient, be aware that any disclosure, dissemination, distribution or copying of this communication, or the use of its contents, is prohibited. If you have received this message in error, please immediately notify the sender of your inadvertent receipt and delete this message from all data storage systems. Thank you

---

**From:** Joaquin P. Pangelinan <jppangelinan@portofguam.com>  
**Sent:** Thursday, October 5, 2023 8:03 AM  
**To:** Patrick Chargualaf <Patrick@morricoequipment.com>  
**Cc:** Ross Morrison <Ross@morricoequipment.com>; Jesse Munoz <Jesse.Munoz@morricoequipment.com>  
**Subject:** Re: Boom Lift Market Survey



Good Morning Pat,  
Thanks for the document, any idea of cost?  
Kin

---

**From:** "patrick" <Patrick@morricequipment.com>  
**To:** "Joaquin Pangelinan" <jppangelinan@portofguam.com>  
**Cc:** "Ross Morrison" <Ross@morricequipment.com>, "Jesse Munoz" <Jesse.Munoz@morricequipment.com>  
**Sent:** Wednesday, October 4, 2023 5:06:28 PM  
**Subject:** Re: Boom Lift Market Survey

Kin,

Good evening.

Attached sample COO From JLG for review.

Please advise if sufficient for BAA certification.

Regards,

Patrick Mafnas Chargualaf  
Generator and Equipment Sales  
Morrice Equipment

+1 (671) 649-1946 Office

+1 (671) 649-1947 Fax

+1 (671) 688-0309 Cell



<http://www.morricequipment.com>

**IMPORTANT:** The sender intends that this electronic message is for exclusive use by the person to whom it is addressed. This message may contain information that is confidential or privileged and exempt from disclosure under applicable law. If the reader of this message is not an intended recipient, be aware that any disclosure, dissemination, distribution or copying of this communication, or the use of its contents, is prohibited. If you have received this message in error, please immediately notify the sender of your inadvertent receipt and delete this message from all data storage systems. Thank you

---

**From:** Patrick Chargualaf <Patrick@morricequipment.com>  
**Sent:** Monday, October 2, 2023 5:57 PM  
**To:** Joaquin P. Pangelinan <jppangelinan@portofguam.com>  
**Cc:** Ross Morrison <Ross@morricequipment.com>; Jesse Munoz <Jesse.Munoz@morricequipment.com>  
**Subject:** Re: Boom Lift Market Survey

Kin,

Hafa Adai and good evening.

Apologies this is late.

Please see attached and kindly reply with any questions or concerns.

Regards,

Patrick Mafnas Chargualaf  
Generator and Equipment Sales  
Morrice Equipment

+1 (671) 649-1946 Office  
+1 (671) 649-1947 Fax  
+1 (671) 688-0309 Cell



<http://www.morricequipment.com>

**IMPORTANT:** The sender intends that this electronic message is for exclusive use by the person to whom it is addressed. This message may contain information that is confidential or privileged and exempt from disclosure under applicable law. If the reader of this message is not an intended recipient, be aware that any disclosure, dissemination, distribution or copying of this communication, or the use of its contents, is prohibited. If you have received this message in error, please immediately notify the sender of your inadvertent receipt and delete this message from all data storage systems. Thank you

---

**From:** Joaquin P. Pangelinan <jppangelinan@portofguam.com>  
**Sent:** Tuesday, September 26, 2023 9:15 AM  
**To:** Patrick Chargualaf <Patrick@morricequipment.com>  
**Subject:** Re: Boom Lift Market Survey

thanks Pat

---

**From:** "patrick" <Patrick@morricequipment.com>  
**To:** "Joaquin Pangelinan" <jppangelinan@portofguam.com>  
**Sent:** Tuesday, September 26, 2023 8:29:41 AM  
**Subject:** Re: Boom Lift Market Survey

Kin,

Have budget number and lead time and sending latest tomorrow.

Regards,

Patrick Mafnas Chargualaf  
Generator and Equipment Sales  
Morrice Equipment

+1 (671) 649-1946 Office  
+1 (671) 649-1947 Fax  
+1 (671) 688-0309 Cell



<http://www.morriceequipment.com>

**IMPORTANT:** The sender intends that this electronic message is for exclusive use by the person to whom it is addressed. This message may contain information that is confidential or privileged and exempt from disclosure under applicable law. If the reader of this message is not an intended recipient, be aware that any disclosure, dissemination, distribution or copying of this communication, or the use of its contents, is prohibited. If you have received this message in error, please immediately notify the sender of your inadvertent receipt and delete this message from all data storage systems. Thank you

---

**From:** Joaquin P. Pangelinan <jppangelinan@portofguam.com>  
**Sent:** Tuesday, September 26, 2023 8:28 AM  
**To:** Patrick Chargualaf <Patrick@morriceequipment.com>  
**Subject:** Re: Boom Lift Market Survey

Good Morning Pat,  
Following up on 180' Boom List market Survey.  
Thanks,  
Kin

**From:** "Joaquin Pangelinan" <jppangelinan@portofguam.com>  
**To:** "patrick" <Patrick@morricequipment.com>  
**Sent:** Wednesday, September 20, 2023 12:26:15 PM  
**Subject:** Re: Boom Lift Market Survey

Thanks Pat

---

**From:** "patrick" <Patrick@morricequipment.com>  
**To:** "Joaquin Pangelinan" <jppangelinan@portofguam.com>  
**Cc:** "Jesse Munoz" <Jesse.Munoz@morricequipment.com>  
**Sent:** Wednesday, September 20, 2023 12:11:52 PM  
**Subject:** Re: Boom Lift Market Survey

Kin,

Received and thank you.

I'll revalidate previous proposal and send ASAP.

Regards,

Patrick Mafnas Chargualaf  
Generator and Equipment Sales  
Morrice Equipment

+1 (671) 649-1946 Office  
+1 (671) 649-1947 Fax  
+1 (671) 688-0309 Cell



<http://www.morriceequipment.com>

**IMPORTANT:** The sender intends that this electronic message is for exclusive use by the person to whom it is addressed. This message may contain information that is confidential or privileged and exempt from disclosure under applicable law. If the reader of this message is not an intended recipient, be aware that any disclosure, dissemination, distribution or copying of this communication, or the use of its contents, is prohibited. If you have received this message in error, please immediately notify the sender of your inadvertent receipt and delete this message from all data storage systems. Thank you

---

**From:** Joaquin P. Pangelinan <jppangelinan@portofguam.com>

**Sent:** Wednesday, September 20, 2023 12:07 PM  
**To:** Patrick Chargualaf <patrick@morricoequipment.com>  
**Subject:** Boom Lift Market Survey

Good Morning Patrick,  
Sent this to Angel(not sure he's still there), so also sending to you.

Attached is a Market Survey for a 180' Boom Lift, please complete and return as soon as possible.

Respectfully  
Joaquin P. Pangelinan  
Manager Equipment Support Services  
Maintenance Department  
Port Authority of Guam  
1026 Cabras Highway, Ste. 201 Piti, GU 96925  
Phone (671)477-5931 ex. 223  
jppangelinan@portofguam.com

---

 **Market Survey; 180 Boom Lift - Morrico Equipment submitted 2 Oct 2023.pdf**  
277 KB

---



## CERTIFICATE OF ORIGIN

**DATE:** 12/13/2022

**TRADE NAME** JLG Industries, Inc.

**YEAR:** xxx

**MODEL:** 1850SJ Boom Lift

**SERIAL NO:** xxxxxxxx

**To Whom It May Concern:**

**JLG hereby declares that the goods purchased from JLG Industries, Inc.,  
McConnellsburg, PA have been manufactured in the United States and are products of  
the United States of America.**

**By: Alyssa Xu**  
Sales Analyst



**PORT OF GUAM**  
ATURIDATI PUETTON GUAHAN  
Jose D. Leon Guerrero Commercial Port  
1026 Cabras Highway, Suite 201, Piti, Guam 96915  
Telephone: 671-477-5931/35 Facsimile: 671-477-2689/4445  
Website: [www.portguam.com](http://www.portguam.com)



Lourdes A. Leon Guerrero  
Governor of Guam  
Joshua F. Tenorio  
Lieutenant Governor

**Market Research Survey**  
**180' Telescopic Boom Lift**  
**September 18, 2023**

**COMPANY NAME:**       Morrico Equipment      

Hafa Adai yan Buenas!

The Port Authority of Guam is interested in Purchasing a New Telescopic Boom Lift. We will be looking to purchase a Boom Lift with a reach of 180 feet and 750 lbs. Basket Capacity. We have a few requirements for Boom Lift. Below is a list of survey questions that we are requesting responses for. *(please refer to the non-disclosure agreement below)*

1. Is your Company an authorized service provider/dealer/ distributor for a Telescopic Boom Lift Manufacturer?
  - Yes, JLG
  
2. Does your company offer the above equipment and does it meet the Build American Buy American Act(BABAA).
  - Yes
  
3. Will your company be able a Build America Buy America Act Certificate from the manufacturer?
  - To be Confirmed
  
4. Does your company stock parts for said Boom Lifts?
  - Yes
  
5. What would your delivery time be for said Boom Lift?
  - 12 to 14 months
  
6. If you can supply unit, what are Warranty options?
  - Manufacturer's standard "1 and 5 Years"
  
7. Does your company employ certified technicians with proprietary software to troubleshoot, diagnose, repair Boom Lifts?
  - Yes

8. At what price range can you offer New Boom Lift? (optional, see non-disclosure agreement below)

- \$ 640,500.00 USD

Digitally signed by Patrick Mabret Chargualaf  
DN: cn=Patrick Mabret Chargualaf, o=Morocco Equipment LLC,  
ou=Generator and Equipment Sales,  
email=patrick.generator@equipment.com, c=GU  
Date: 2023.10.02 17:56:42 +1000

NAME OF INDIVIDUAL WHO COMPLETED THIS SURVEY: Patrick Chargualaf, Jesse Munoz, Ross Morrison

We thank you for your taking the time to complete this survey. Please forward your responses to [jppangelinan@portguam.com](mailto:jppangelinan@portguam.com) or [epbagaforo@portguam.com](mailto:epbagaforo@portguam.com)

The above website is for sample purposes only and not indicative of any budgetary or cost that the Port relies on.

Thank you for your taking the time to complete this survey. Please forward your responses to [paprocurement@portofguam.com](mailto:paprocurement@portofguam.com), [algsablan@portofguam.com](mailto:algsablan@portofguam.com), [macabrera@portofguam.com](mailto:macabrera@portofguam.com), [jppangelinan@portofguam.com](mailto:jppangelinan@portofguam.com), [egpangelinan@portofguam.com](mailto:egpangelinan@portofguam.com). *Non-disclosure Agreement: The purpose of this market research survey is to gauge the current market for the above services request, and to establish a budgetary amount. All information provided to the Port of Guam shall be kept strictly confidential and will not be shared, used, or distributed without written consent. The Port Authority of Guam will only use the information for the procurement planning and acquisition of the above request services. Taking this survey is completely optional and you have every right to refuse completing it. However, the information you provide will assist the Port Authority of Guam prepare the most effective method of procuring these services. The Port Authority of Guam promotes a fair and transparent procurement process and encourages all to participate.*



Zimbra

jppangelinan@portofguam.com

---

**Re: Boom Lift Market Survey**

---

**From :** Joaquin P. Pangelinan  
<jppangelinan@portofguam.com>

Tue, Sep 26, 2023 08:31 AM

**Subject :** Re: Boom Lift Market Survey

**To :** John Limtiaco <jlimtiaco@pacificunlimitedguam.com>

Good Morning John,  
Following up on 180' Boom List Market Survey.  
Thanks,  
Kin

---

**From:** "Joaquin Pangelinan" <jppangelinan@portofguam.com>  
**To:** "John Limtiaco" <jlimtiaco@pacificunlimitedguam.com>  
**Cc:** "Evelyn G. Pangelinan" <egpangelinan@portofguam.com>  
**Sent:** Tuesday, September 19, 2023 9:22:28 AM  
**Subject:** Boom Lift Market Survey

Good Morning John,

Attached is a Market Survey for a 180' Boom Lift, please complete and return as soon as possible.

Respectfully  
Joaquin P. Pangelinan  
Manager Equipment Support Services  
Maintenance Department  
Port Authority of Guam  
1026 Cabras Highway, Ste. 201 Piti, GU 96925  
Phone (671)477-5931 ex. 223  
jppangelinan@portofguam.com

---



**PORT OF GUAM**  
ATURIDATI PUEYI TON GUAHAN  
Jose D. Leon Guerrero Commercial Port  
1026 Cabras Highway, Suite 201, Piti, Guam 96915  
Telephone: 671-477-5931/35 Facsimile: 671-477-2689/4445  
Website: [www.portguam.com](http://www.portguam.com)



Lourdes A. Leon Guerrero  
Governor of Guam  
Joshua F. Tenorio  
Lieutenant Governor

## Market Research Survey 180' Telescopic Boom Lift September 18, 2023

**COMPANY NAME:** \_\_\_\_\_

Hafa Adai yan Buenas!

The Port Authority of Guam is interested in Purchasing a New Telescopic Boom Lift. We will be looking to purchase a Boom Lift with a reach of 180 feet and 750 lbs. Basket Capacity. We have a few requirements for Boom Lift. Below is a list of survey questions that we are requesting responses for. *(please refer to the non-disclosure agreement below)*

1. Is your Company an authorized service provider/dealer/ distributor for a Telescopic Boom Lift Manufacturer?
2. Does your company offer the above equipment and does it meet the Build American Buy American Act(BABAA).
3. Will your company be able a Build America Buy America Act Certificate from the manufacturer?
4. Does your company stock parts for said Boom Lifts?
5. What would your delivery time be for said Boom Lift?
6. If you can supply unit, what are Warranty options?
7. Does your company employ certified technicians with proprietary software to troubleshoot, diagnose, repair Boom Lifts?
8. At what price range can you offer New Boom Lift? (optional, see non-disclosure agreement below)

NAME OF INDIVIDUAL WHO COMPLETED THIS SURVEY: \_\_\_\_\_

We thank you for your taking the time to complete this survey. Please forward your responses to [jppangelinan@portguam.com](mailto:jppangelinan@portguam.com) or [epbagaforo@portguam.com](mailto:epbagaforo@portguam.com)

The above website is for sample purposes only and not indicative of any budgetary or cost that the Port relies on.

Thank you for your taking the time to complete this survey. Please forward your responses to [pagprocurement@portofguam.com](mailto:pagprocurement@portofguam.com), [algsablan@portofguam.com](mailto:algsablan@portofguam.com), [macabrera@portofguam.com](mailto:macabrera@portofguam.com), [jppangelinan@portofguam.com](mailto:jppangelinan@portofguam.com), [egpangelinan@portofguam.com](mailto:egpangelinan@portofguam.com). *Non-disclosure Agreement: The purpose of this market research survey is to gauge the current market for the above services request, and to establish a budgetary amount. All information provided to the Port of Guam shall be kept strictly confidential and will not be shared, used, or distributed without written consent. The Port Authority of Guam will only use the information for the procurement planning and acquisition of the above request services. Taking this survey is completely optional and you have every right to refuse completing it. However, the information you provide will assist the Port Authority of Guam prepare the most effective method of procuring these services. The Port Authority of Guam promotes a fair and transparent procurement process and encourages all to participate.*

Zimbra

jppangelinan@portofguam.com

---

**Boom Lift Market Survey**

---

**From :** Joaquin P. Pangelinan  
<jppangelinan@portofguam.com>

Tue, Sep 19, 2023 09:25 AM

 1 attachment

**Subject :** Boom Lift Market Survey

**To :** Dave Benavente <dave.benavente@lmsfm.com>

**Cc :** Evelyn G. Pangelinan  
<egpangelinan@portofguam.com>

Good Morning Dave,

Attached is a Market Survey for a 180' Boom Lift, please complete and return as soon as possible.

Respectfully  
Joaquin P. Pangelinan  
Manager Equipment Support Services  
Maintenance Department  
Port Authority of Guam  
1026 Cabras Highway, Ste. 201 Piti, GU 96925  
Phone (671)477-5931 ex. 223  
jppangelinan@portofguam.com

---

 **Market Survey; 180 Boom Lift.docx**  
246 KB

---

Zimbra

jppangelinan@portofguam.com

---

**Re: 180 Boom Lift Market Survey**

---

**From :** Joaquin P. Pangelinan  
<jppangelinan@portofguam.com>

Tue, Sep 26, 2023 08:30 AM

**Subject :** Re: 180 Boom Lift Market Survey

**To :** Dave Benavente <dave.benavente@lmsfm.com>

Good Morning Dave,  
Following up on 180' Boom List market Survey.  
Thanks,  
Kin

---

**From:** "Joaquin Pangelinan" <jppangelinan@portofguam.com>  
**To:** "Dave Benavente" <dave.benavente@lmsfm.com>  
**Sent:** Wednesday, September 20, 2023 12:11:21 PM  
**Subject:** 180 Boom Lift Market Survey

Dave,  
sent you a Market Survey, please confirm you received it.

Respectfully  
Joaquin P. Pangelinan  
Manager Equipment Support Services  
Maintenance Department  
Port Authority of Guam  
1026 Cabras Highway, Ste. 201 Piti, GU 96925  
Phone (671)477-5931 ex. 223  
jppangelinan@portofguam.com

---



**PORT OF GUAM**  
ATURIDAT I PUETTON GUAHAN  
Jose D. Leon Guerrero Commercial Port  
1026 Cabras Highway, Suite 201, Piti, Guam 96915  
Telephone: 671-477-5931/35 Facsimile: 671-477-2689/4445  
Website: [www.portguam.com](http://www.portguam.com)



Lourdes A. Leon Guerrero  
Governor of Guam  
Joshua F. Tenorio  
Lieutenant Governor

**Market Research Survey**  
**180' Telescopic Boom Lift**  
**September 18, 2023**

COMPANY NAME: LMS Guam

Hafa Adai yan Buenas!

The Port Authority of Guam is interested in Purchasing a New Telescopic Boom Lift. We will be looking to purchase a Boom Lift with a reach of 180 feet and 750 lbs. Basket Capacity. We have a few requirements for Boom Lift. Below is a list of survey questions that we are requesting responses for. *(please refer to the non-disclosure agreement below)*

1. Is your Company an authorized service provider/dealer/ distributor for a Telescopic Boom Lift Manufacturer? *Not Yet.*
2. Does your company offer the above equipment and does it meet the Build American Buy American Act(BABAA).
3. Will your company be able a Build America Buy America Act Certificate from the manufacturer?
4. Does your company stock parts for said Boom Lifts?
5. What would your delivery time be for said Boom Lift?
6. If you can supply unit, what are Warranty options?
7. Does your company employ certified technicians with proprietary software to troubleshoot, diagnose, repair Boom Lifts?
8. At what price range can you offer New Boom Lift? (optional, see non-disclosure agreement below)

NAME OF INDIVIDUAL WHO COMPLETED THIS SURVEY: Dave Benavente

We thank you for your taking the time to complete this survey. Please forward your responses to [jppangelinan@portguam.com](mailto:jppangelinan@portguam.com) or [epbagaforo@portguam.com](mailto:epbagaforo@portguam.com)

The above website is for sample purposes only and not indicative of any budgetary or cost that the Port relies on.

Thank you for your taking the time to complete this survey. Please forward your responses to [pagprocurement@portofguam.com](mailto:pagprocurement@portofguam.com), [algsablan@portofguam.com](mailto:algsablan@portofguam.com), [macabrera@portofguam.com](mailto:macabrera@portofguam.com), [jppangelinan@portofguam.com](mailto:jppangelinan@portofguam.com), [egpangelinan@portofguam.com](mailto:egpangelinan@portofguam.com). *Non-disclosure Agreement: The purpose of this market research survey is to gauge the current market for the above services request, and to establish a budgetary amount. All information provided to the Port of Guam shall be kept strictly confidential and will not be shared, used, or distributed without written consent. The Port Authority of Guam will only use the information for the procurement planning and acquisition of the above request services. Taking this survey is completely optional and you have every right to refuse completing it. However, the information you provide will assist the Port Authority of Guam prepare the most effective method of procuring these services. The Port Authority of Guam promotes a fair and transparent procurement process and encourages all to participate.*

Zimbra

jppangelinan@portofguam.com

---

**Re: Boom Lift Market Survey**

---

**From :** Joaquin P. Pangelinan  
<jppangelinan@portofguam.com>

Tue, Sep 26, 2023 08:31 AM

**Subject :** Re: Boom Lift Market Survey

**To :** Eric Aquai <eaquai@hawthornecat.com>, Jimmy Cruz  
<jpcruz@hawthornecat.com>

**Cc :** Evelyn G. Pangelinan  
<egpangelinan@portofguam.com>

Good Morning Jimmy,  
Following up on 180' Boom List market Survey.  
Thanks,  
Kin

---

**From:** "Joaquin Pangelinan" <jppangelinan@portofguam.com>  
**To:** "Eric Aquai" <eaquai@hawthornecat.com>, "Jimmy Cruz"  
<jpcruz@hawthornecat.com>  
**Cc:** "Evelyn G. Pangelinan" <egpangelinan@portofguam.com>  
**Sent:** Tuesday, September 19, 2023 9:10:34 AM  
**Subject:** Boom Lift Market Survey

Good Morning Jim,  
Attached is a Market Survey for a 180' Man Lift, please complete and return as soon as possible.

Respectfully  
Joaquin P. Pangelinan  
Manager Equipment Support Services  
Maintenance Department  
Port Authority of Guam  
1026 Cabras Highway, Ste. 201 Piti, GU 96925  
Phone (671)477-5931 ex. 223  
jppangelinan@portofguam.com

---



Zimbra

jppangelinan@portofguam.com

**FW: Guam 180ft Boom**

**From :** Eric Aquai <eaquai@hawthornecat.com>  
**Subject :** FW: Guam 180ft Boom  
**To :** Joaquin P. Pangelinan <jppangelinan@portofguam.com>

Tue, Oct 03, 2023 07:44 AM  
5 attachments

**Eric Aquai**  
Parts Supervisor

671-649-4207 | 671-487-3444

eaquai@hawthornecat.com

www.hawthornecat.com

196 E. Harmon Industrial Park Road, Tamuning, Guam  
96913



**From:** Jimmy Cruz <jpcruz@hawthornecat.com>  
**Sent:** Tuesday, October 3, 2023 7:36 AM  
**To:** Eric Aquai <eaquai@hawthornecat.com>  
**Subject:** Fwd: Guam 180ft Boom

FYI.

I think that we will not be submitting a quote for this request.

Sent from my iPhone

**Jimmy Cruz**  
Account Manager

671-649-4216 | 671-488-2821



[jpcruz@hawthornecat.com](mailto:jpcruz@hawthornecat.com)

[www.hawthornecat.com](http://www.hawthornecat.com)

196 E. Harmon Industrial Park Road, Tamuning, Guam  
96913



Begin forwarded message:

**From:** "Walsh, Ryan" <[Ryan.Walsh@terex.com](mailto:Ryan.Walsh@terex.com)>  
**Date:** October 3, 2023 at 01:31:11 GMT+10  
**To:** Jimmy Cruz <[jpcruz@hawthornecat.com](mailto:jpcruz@hawthornecat.com)>  
**Subject:** **\*\*EXTERNAL\*\* Guam 180ft Boom**

**CAUTION: EXTERNAL EMAIL**

This email has originated from [Ryan.Walsh@terex.com](mailto:Ryan.Walsh@terex.com)

**DO NOT REPLY, CLICK LINKS or OPEN ATTACHMENTS** unless you recognize the sender's email address and know the content is safe..

Jimmy,

I am currently waiting on guidance for machines heading to Guam. It does not appear that our boom lift qualifies for the BABA program dues to the amount of foreign parts that are used. As soon as I hear from the team with quote guidelines, I will get you some numbers. Sorry for the continued delay

**Ryan Walsh**

Regional Sales Manager, West

Mobile (425) 658-6462

Email [ryan.walsh@terex.com](mailto:ryan.walsh@terex.com)

Web [www.genielift.com](http://www.genielift.com)





**PORT OF GUAM**  
ATURIDAT I PUETTON GUAHAN  
Jose D. Leon Guerrero Commercial Port  
1026 Cabras Highway, Suite 201, Piti, Guam 96915  
Telephone: 671-477-5931/35 Facsimile: 671-477-2689/4445  
Website: [www.portguam.com](http://www.portguam.com)



**Lourdes A. Leon Guerrero**  
Governor of Guam  
**Joshua F. Tenorio**  
Lieutenant Governor

**Market Research Survey**  
**180' Telescopic Boom Lift**  
**September 18, 2023**

**COMPANY NAME:** \_\_\_\_\_

Hafa Adai yan Buenas!

The Port Authority of Guam is interested in Purchasing a New Telescopic Boom Lift. We will be looking to purchase a Boom Lift with a reach of 180 feet and 750 lbs. Basket Capacity. We have a few requirements for Boom Lift. Below is a list of survey questions that we are requesting responses for. *(please refer to the non-disclosure agreement below)*

1. Is your Company an authorized service provider/dealer/ distributor for a Telescopic Boom Lift Manufacturer?
2. Does your company offer the above equipment and does it meet the Build American Buy American Act(BABAA).
3. Will your company be able a Build America Buy America Act Certificate from the manufacturer?
4. Does your company stock parts for said Boom Lifts?
5. What would your delivery time be for said Boom Lift?
6. If you can supply unit, what are Warranty options?
7. Does your company employ certified technicians with proprietary software to troubleshoot, diagnose, repair Boom Lifts?
8. At what price range can you offer New Boom Lift? (optional, see non-disclosure agreement below)

NAME OF INDIVIDUAL WHO COMPLETED THIS SURVEY: \_\_\_\_\_

We thank you for your taking the time to complete this survey. Please forward your responses to [jppangelinan@portguam.com](mailto:jppangelinan@portguam.com) or [epbagaforo@portguam.com](mailto:epbagaforo@portguam.com)

The above website is for sample purposes only and not indicative of any budgetary or cost that the Port relies on.

Thank you for your taking the time to complete this survey. Please forward your responses to [pagprocurement@portofguam.com](mailto:pagprocurement@portofguam.com), [algsablan@portofguam.com](mailto:algsablan@portofguam.com), [macabrera@portofguam.com](mailto:macabrera@portofguam.com), [jppangelinan@portofguam.com](mailto:jppangelinan@portofguam.com), [egpangelinan@portofguam.com](mailto:egpangelinan@portofguam.com). *Non-disclosure Agreement: The purpose of this market research survey is to gauge the current market for the above services request, and to establish a budgetary amount. All information provided to the Port of Guam shall be kept strictly confidential and will not be shared, used, or distributed without written consent. The Port Authority of Guam will only use the information for the procurement planning and acquisition of the above request services. Taking this survey is completely optional and you have every right to refuse completing it. However, the information you provide will assist the Port Authority of Guam prepare the most effective method of procuring these services. The Port Authority of Guam promotes a fair and transparent procurement process and encourages all to participate.*

# 1850SJ

## TELESCOPIC ULTRA BOOM

BOOM LIFT

# JLG



### KEY SPECS

**Platform Height**  
185-ft 7-in / 56.56-m

**Horizontal Outreach**  
80-ft / 24.38-m

**Drive Speed**  
2.8 mph / 4.5 km/h

**Platform Capacity**  
1,000-lb / 454-kg - Restricted  
500-lb / 227-kg - Unrestricted

### KEY FEATURES

- Expansive work area of a maximum platform height of 185-ft and a telescoping jib that provides 2.9 million cubic feet of work area.
- Optimized maneuverability with full-time four-wheel drive to traverse over rough terrain.
- Enhanced Platform Controls - An LCD screen shows operators where they are in the work envelope, along with other useful information.
- Single sensor load sensing system features fewer parts and requires no weight to calibrate.

### ACCESSORIES & OPTIONS

- Accessory Packages
  - SkyWelder® Package
  - SkyPower® Package
  - SkyGlazier® Package
- Ambient White Noise Alarm
- Bolt On Fall Arrest System
- Cold Package Plus<sup>1</sup>
- Cold Weather Package<sup>2</sup>
- Hostile Environment Package<sup>1</sup>
- Light Package
- Platform Mesh, Bolt On
  - Mesh to Top Rail, Plastic or Aluminum
  - Mesh to Mid Rail, Plastic or Aluminum
- Platform Options
  - Fall Arrest, Rear Entry - 36 x 96-in
  - Drop Bar - 30 x 36-in, 36 x 96-in
  - Inward Self-Closing Swing Gate - 36 x 72-in, 36 x 96-in
  - Tri-Entry, Drop Bar - 36 x 72-in, 36 x 96-in
  - Tri-Entry, Swing Gate - 36 x 72-in, 36 x 96-in
- SkySense® Enhanced Detection System
- Soft Touch System
- Storage Tray, Center or Corner

### STANDARD SPECIFICATIONS

#### Performance

Platform Height	185-ft 7-in / 56.56-m
Horizontal Outreach	80-ft / 24.38-m
Swing	360 Degrees Continuous
Platform Capacity (Restricted)	1,000-lb / 454-kg
Platform Capacity (Unrestricted)	500-lb / 227-kg
Platform Rotator	173 Degrees Hydraulic
Jib Length (Retracted/Extended)	13-ft (3.96-m) / 20-ft (6.1-m)
Jib Range of Articulation	120 Degrees (+75, -45)
Weight*	59,900-lb / 27,170-kg
Max. Ground Bearing Pressure	119.6 psi / 8.41 kg/cm <sup>2</sup>
Drive Speed	2.8 mph / 4.5 km/h
Gradeability	40%
Tilt Cut Out	5 Degrees
Turning Radius (Inside):	
Axles Retracted/Extended	23-ft 4-in (7.12-m) / 7-ft 7-in (2.3-m)
Turning Radius (Outside):	
Axles Retracted/Extended	31-ft 3-in (9.52-m) / 21-ft 8-in (6.6-m)

#### Engine

Diesel Engine - Deutz TCD 3.6L Tier IV F	99.8 hp / 74.4 kW
Fuel Tank Capacity	45 gal / 170 L

#### Tires

Standard	44S/50D710 Foam-filled
----------	------------------------

#### Hydraulic System

Capacity	75.1 gal / 284.2 L
----------	--------------------

### STANDARD FEATURES

- 12V DC Auxiliary Power
- 173 Degrees Hydraulic Platform Rotator
- 3 Selectable Steering Modes
- AC Receptacle In Platform
- All Motion Alarm
- ClearSky Smart Fleet™ Hardware (CSS50)\*\*
- Control ADE® System
- Drive-Out Extendable Axles
- Engine Distress Warning/Shutdown—Selectable via JLG Analyzer
- Full-Time 4WD
- Glow Plugs
- Gull-Wing Steel Hoods
- Hourmeter
- LED Motion/Amber Beacon (CSS50)\*\*
- Lifting/Tie Down Lugs
- Load Sensing System
- LCD Panel at Operator's Platform Control Console
- Platform 36 x 96-in (91 x 2.44-m) Side Entry
- Proportional Controls
- Platform Console Machine Status Light Panel\*\*\*
- Selectable Capacity Envelope
- Swing Out Engine Tray
- SkyGuard SkyLine™
- Tilt Light and Alarm

\*Certain Options or Country Standards Increase Weight

\*\*Standard Beacon and ClearSky Smart Fleet Hardware Availability Varies by Model Throughout 2021

\*\*\*Provides Indicator Lights at Platform Control Console for System Distress, Low Fuel, Degree Tilt Light and Foot Switch Status

1 Includes extreme cold engine oil, fuel conditioner, engine block heater, battery blanket, glow plugs, hydraulic tank heater, and oversized footswitch

2 Includes battery blanket, hydraulic tank heater, block heater

3 Includes console cover, boom wipers and cylinder bellows

Additional accessories and options available via JLG Aftermarket

Shown with Optional Mesh to Top Rail

# 1850SJ

## TELESCOPIC ULTRA BOOM

BOOM LIFT



### DIMENSIONS

All dimensions are approximate

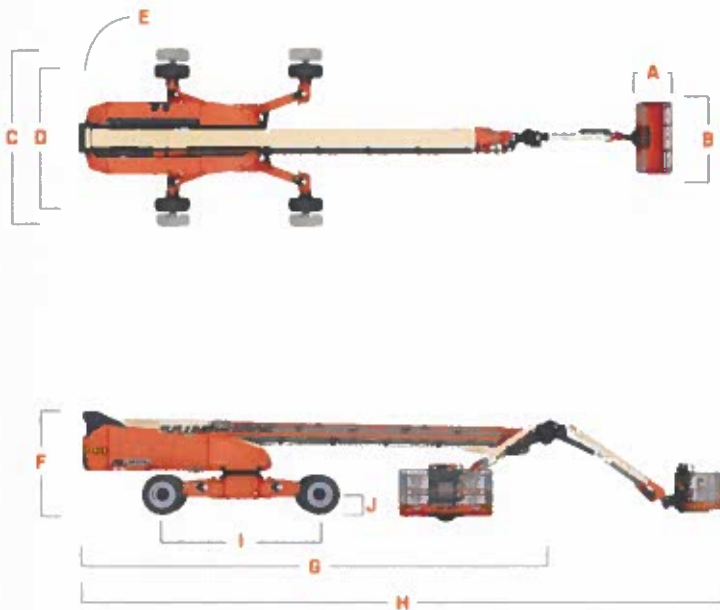

<b>A.</b> Platform Width	36-in / 91-cm
<b>B.</b> Platform Length	96-in / 2.44-m
<b>C.</b> Machine Width - Axles Extended	16-ft 6-in / 5-m
<b>D.</b> Machine Width - Axles Retracted	8-ft 2-in / 2.49-m
<b>E.</b> Tailswing	7-ft 7-in / 2.32-m
<b>F.</b> Machine Height	10-ft / 3.05-m
<b>G.</b> Machine Length - Stowed	47-ft 9.5-in / 14.57-m
<b>H.</b> Machine Length - Overall	63-ft 10-in / 19.45-m
<b>I.</b> Wheelbase	17-ft 1.5-in / 5.22-m
<b>J.</b> Ground Clearance	13.5-in / 34-cm - Axle 16.25-in / 41-cm - Chassis

### REACH DIAGRAM

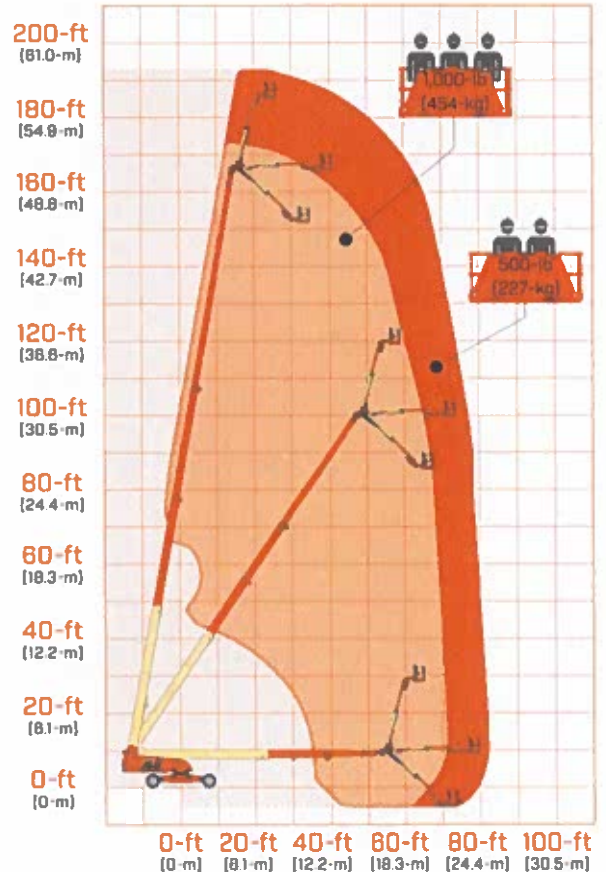

We provide coverage for one (1) full year, and cover all specified major structural components for five (5) years. Due to continuous product improvements, we reserve the right to make specification and/or equipment changes without prior notification. This machine meets or exceeds applicable ANSI and CSA requirements based on machine configuration as originally manufactured for intended applications. Please reference the serial number plate on the machine for additional information.



JLG INDUSTRIES, INC.  
Toll-free US 877-JLG-LIFT  
JLG.com

An Oshkosh Corporation Company

# 1850SJ

## TELESCOPIC ULTRA BOOM

BOOM LIFT

# JLG



### KEY SPECS

**Platform Height**  
185-ft 7-in / 56.56-m

**Horizontal Outreach**  
80-ft / 24.38-m

**Drive Speed**  
2.8 mph / 4.5 km/h

**Platform Capacity**  
1,000-lb / 454-kg - Restricted  
500-lb / 227-kg - Unrestricted

### KEY FEATURES

- Expansive work area of a maximum platform height of 185-ft and a telescoping jib that provides 2.9 million cubic feet of work area.
- Optimized maneuverability with full-time four-wheel drive to traverse over rough terrain.
- Enhanced Platform Controls - An LCD screen shows operators where they are in the work envelope, along with other useful information.
- Single sensor load sensing system features fewer parts and requires no weight to calibrate.

### ACCESSORIES & OPTIONS

- Accessory Packages
  - SkyWelder® Package
  - SkyPower® Package
  - SkyGlazier® Package
- Ambient White Noise Alarm
- Bolt On Fall Arrest System
- Cold Package Plus<sup>1</sup>
- Cold Weather Package<sup>2</sup>
- Hostile Environment Package<sup>1</sup>
- Light Package
- Platform Mesh, Bolt On
  - Mesh to Top Rail, Plastic or Aluminum
- Mesh to Mid Rail, Plastic or Aluminum
- Platform Options
  - Fall Arrest, Rear Entry - 36 x 96-in
  - Drop Bar - 30 x 36-in, 36 x 96-in
  - Inward Self-Closing Swing Gate - 36 x 72-in, 36 x 96-in
  - Tri-Entry, Drop Bar - 36 x 72-in, 36 x 96-in
  - Tri-Entry, Swing Gate - 36 x 72-in, 36 x 96-in
- SkySense® Enhanced Detection System
- Soft Touch System
- Storage Tray, Center or Corner

### STANDARD SPECIFICATIONS

#### Performance

Platform Height	185-ft 7-in / 56.56-m
Horizontal Outreach	80-ft / 24.38-m
Swing	360 Degrees Continuous
Platform Capacity (Restricted)	1,000-lb / 454-kg
Platform Capacity (Unrestricted)	500-lb / 227-kg
Platform Rotator	173 Degrees Hydraulic
Jib Length (Retracted/Extended)	13-ft (3.96-m) / 20-ft (6.1-m)
Jib Range of Articulation	120 Degrees (+75, -45)
Weight*	59,900-lb / 27,170-kg
Max. Ground Bearing Pressure	119.6 psi / 8.41 kg/cm <sup>2</sup>
Drive Speed	2.8 mph / 4.5 km/h
Gradeability	40%
Tilt Cut Out	5 Degrees
Turning Radius (Inside)	
Axles Retracted/Extended	23-ft 4-in (7.12-m) / 7-ft 7-in (2.3-m)
Turning Radius (Outside):	
Axles Retracted/Extended	31-ft 3-in (9.52-m) / 21-ft 8-in (6.6-m)

#### Engine

Diesel Engine - Deutz TCD 3.6L Tier IV F	99.8 hp / 74.4 kW
Fuel Tank Capacity	45 gal / 170 L

#### Tires

Standard	44S/50D710 Foam-filled
----------	------------------------

#### Hydraulic System

Capacity	75.1 gal / 284.2 L
----------	--------------------

### STANDARD FEATURES

- 12V-DC Auxiliary Power
- 173 Degrees Hydraulic Platform Rotator
- 3 Selectable Steering Modes
- AC Receptacle in Platform
- All Motion Alarm
- ClearSky Smart Fleet™ Hardware (CS550)\*\*
- Control ADE® System
- Drive-Out Extendable Axles
- Engine Distress Warning/Shutdown—Selectable via JLG Analyzer
- Full-Time 4WD
- Glow Plugs
- Gull-Wing Steel Hoods
- Hourmeter
- LED Motion/Amber Beacon (CS550)\*\*
- Lifting/Tie Down Lugs
- Load Sensing System
- LCD Panel at Operator's Platform Control Console
- Platform 36 x 96-In (91 x 2.44-m) Side Entry
- Proportional Controls
- Platform Console Machine Status Light Panel\*\*\*
- Selectable Capacity Envelope
- Swing Out Engine Tray
- SkyGuard SkyLine™
- Tilt Light and Alarm

\*Certain Options or Country Standards Increase Weight

\*\*Standard Beacon and ClearSky Smart Fleet Hardware Availability Varies by Model Throughout 2023

\*\*\*Provides Indicator Lights at Platform Control Console for System Distress, Low Fuel, Degree Tilt Light and Foot Switch Status

1 Includes extreme cold engine oil, fuel conditioners, engine block heater, battery blanket, glow plugs, hydraulic tank heater, and oversized footswitch

2 Includes battery blanket, hydraulic tank heater, block heater

3 Includes console cover, boom wipers and cylinder bellows

Additional accessories and options available via JLG Aftermarket

Shown with Optional Mesh to Top Rail

# 1850SJ

## TELESCOPIC ULTRA BOOM

BOOM LIFT



### DIMENSIONS

All dimensions are approximate

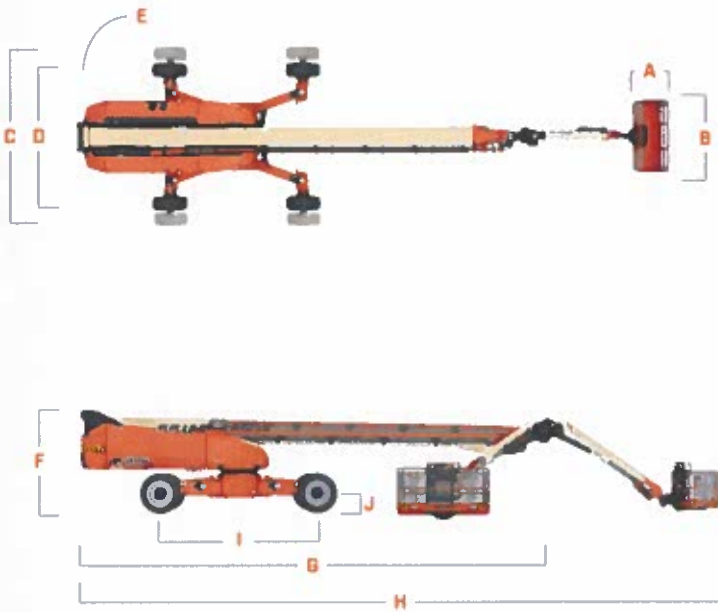

<b>A.</b> Platform Width	36-in / 91-cm
<b>B.</b> Platform Length	96-in / 2.44-m
<b>C.</b> Machine Width - Axles Extended	16-ft 6-in / 5-m
<b>D.</b> Machine Width - Axles Retracted	8-ft 2-in / 2.49-m
<b>E.</b> Tallswing	7-ft 7-in / 2.32-m
<b>F.</b> Machine Height	10-ft / 3.05-m
<b>G.</b> Machine Length - Stowed	47-ft 9.5-in / 14.57-m
<b>H.</b> Machine Length - Overall	63-ft 10-in / 19.45-m
<b>I.</b> Wheelbase	17-ft 1.5-in / 5.22-m
<b>J.</b> Ground Clearance	13.5-in / 34-cm - Axle 16.25-in / 41-cm - Chassis

### REACH DIAGRAM

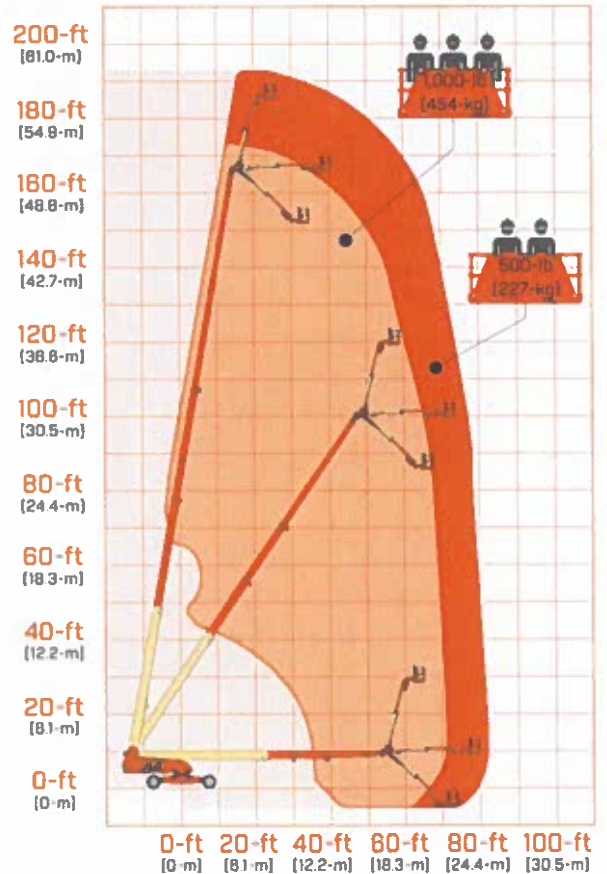

We provide coverage for one (1) full year, and cover all specified major structural components for five (5) years. Due to continuous product improvements, we reserve the right to make specification and/or equipment changes without prior notification. This machine meets or exceeds applicable ANSI and CSA requirements based on machine configuration as originally manufactured for intended applications. Please reference the serial number plate on the machine for additional information.



JLG INDUSTRIES, INC.  
Toll-free US 877-JLG-LIFT  
JLG.com

An Oshkosh Corporation Company



## **Certification requirements for procurement of steel, iron, construction materials, or manufactured products.**

If steel, iron, construction materials, or manufactured products (as defined in § 70914(a) of the Build America, Buy America Act, Pub. L. No. 117-58, div. G, tit. IX, subtit. A, 135 Stat. 429, 1298 (2021) and Office of Management and Budget (OMB) Memorandum M-22-11, "Initial Implementation Guidance on Application of Buy America Preference in Federal Financial Assistance Programs for Infrastructure," as implemented by MARAD through Term B.5 of the exhibits to the agreement) are being procured, the same or equivalent certificate as set forth below shall be completed and submitted by each bidder or offeror in accordance with the requirement contained in section 2.1 of the agreement.

### **Certificate of Compliance with Buy America Requirements**

The bidder or offeror hereby certifies that it will comply with the requirements of § 70914(a) of the Build America, Buy America Act, Pub. L. No. 117-58, div. G, tit. IX, subtit. A, 135 Stat. 429, 1298 (2021), as implemented by MARAD in Term B.5 of the exhibits to the grant agreement.

Date \_\_\_\_\_

Signature \_\_\_\_\_

Company \_\_\_\_\_

Name \_\_\_\_\_

Title \_\_\_\_\_

### **Certificate of Non-Compliance with Buy America Requirements**

The bidder or offeror hereby certifies that it cannot comply with the requirements of § 70914(a) of the Build America, Buy America Act, Pub. L. No. 117-58, div. G, tit. IX, subtit. A, 135 Stat. 429, as implemented by MARAD in Term B.5 of the exhibits to the grant agreement, but it may qualify for an exception to the requirement pursuant to § 70914(b) of the Build America, Buy America Act and Term B.5.

Date \_\_\_\_\_

Signature \_\_\_\_\_

Company \_\_\_\_\_

Name \_\_\_\_\_

Title \_\_\_\_\_

*Need*

ITEM NO.	DESCRIPTION	QUANTITY	UNIT	UNIT PRICE	EXTENSION
1.1	Telescopic Boom Lift, 180' Reach Full time 4WD		1 EA.	\$ _____	\$ _____

**GENERALS:** These specifications have been written, to describe minimum equipment and performance requirements to be supplied by the equipment manufacture bidding. Reasonable test may be conducted upon delivery before acceptance.

The successful bidder shall furnish all necessary and desirable information and instructions for the proper operation of the equipment.

The government reserves the right to accept and/or reject any and all bids, to waive any defects, Irregularities, or specification discrepancies and to award the bid as council deems to be in the best interest of the government.

**DISCREPANCIES**

**LISTED:** Should any bidder have deviations from these specifications in his bid and cannot meet every requirement of the specifications, he shall submit a letter and attach it to the bid, explaining the deviations, failure to do so will cause the bid to be rejected as being non-responsive.

**DELIVER:** The successful bidder shall deliver one (1) 180' Boom Lift each be new fully assembled and ready for operation to the Port Authority of Guam within 120 days.

**SPECIFICATIONS:**

**BIDDING AND OR REMARKS:**

**Engine:** 74 hp minimum,  
Diesel Engine  
Engine shutoff protection system  
(Low Oil Pressure, High Engine Temperature  
High Transmission Temperature)

\_\_\_\_\_

**Fuel Type:** Diesel (Ultra Low Sulfur) Tier IV

\_\_\_\_\_

**Fuel Tank:** The fuel tank furnished shall be Min. 50 gallon

-----

**Platform reach:** 180ft & 10ft jib

\_\_\_\_\_

**Platform Dimensions:**

36 x 96 with railing & side entry

-----

**Platform Capacity:**

Unrestricted - 500 lbs

\_\_\_\_\_

Restricted - 750 lbs

\_\_\_\_\_

**Platform Rotation:**

160 degrees

\_\_\_\_\_

**Special**

**Provision:** If parts catalog and maintenance repair comes in CD-ROM or Microfiche, bidder must supply to requesting agency. Bidder must still provide hard (book) copy to the requesting agency.

---

**Applicable  
Federal Laws  
And**

**Regulations:** Buy American Act – 41 U.S.C § 8301-8305  
Build America Buy America Act Certificate must be provide by the manufacture.

---

**Training:** Provide 2 sessions on pre inspection, post inspection and safe operational procedures for all operators, leaders, supervisors and dispatchers within Maintenance division.

---

**Warranty:** Manufacturers Standard Warranty, 1 year limited warranty. Service of one (1) year/ 2,000 hours, all parts, labor and oil disposal shall be included at "No Cost to the Government".

Yes, offer as requested.

---

No, Offer the following:

---

The manufacturer Warranty and Boucher shall be specified on items covered and provided in the bid packet. (Bid submission received without written warranty and Boucher as specified will be rejected).

Yes, offer as requested.

---

No, Offer the following:

---

The successful bidder shall provide technical assistance and warranty administration without any cost to "The Port Authority of Guam"

Yes, offer as requested.

---

No, Offer the following:

---

1.2 Bidding on : Telescopic Boom Lift 180' reach, Full time 4WD

MANUFACTURER: \_\_\_\_\_

MAKE: \_\_\_\_\_

MODEL: \_\_\_\_\_

YEAR: \_\_\_\_\_

PLACE OF ORIGIN: \_\_\_\_\_

DATE OF DELIVERY: \_\_\_\_\_

REVEIUED BY:



\_\_\_\_\_  
Acting Superintendent T.M.D  
Department of Public Works

DATE: 10-19-23

PORT AUTHORITY OF GUAM

REQUISITION NUMBER 21658 ON

REF: 1 EACH TELESCOPIC BOOM LIFT, 180' REACH FULL TIME 4WD

These specifications have been developed by the Port Authority of Guam Equipment Maintenance and Transportation Division.

  
\_\_\_\_\_  
RAYMOND B. SANTOS-TRANSPORTATION SUPERINTENDENT

28 Oct 23  
\_\_\_\_\_  
DATE

  
\_\_\_\_\_  
JOAQUIN P. PANGELINAN-EQUIPMENT SERVICE SUPPORT MANAGER

Oct 24, 23  
\_\_\_\_\_  
DATE

REVIEWED BY:

  
\_\_\_\_\_  
GLENN B. NELSON-OPERATIONS MANAGER

W. 24. 23  
\_\_\_\_\_  
DATE

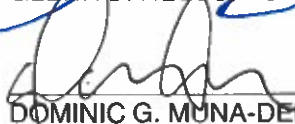
  
\_\_\_\_\_  
DOMINIC G. MUNA-DEPUTY GENERAL MANAGER, OPERATIONS

10/24/23  
\_\_\_\_\_  
DATE

  
\_\_\_\_\_  
PACIFICO MARTIR-DEPUTY GENERAL MANAGER, FINANCE

10/25/23  
\_\_\_\_\_  
DATE

[  ] CONCURRED BY

  
\_\_\_\_\_  
RORY J. RESPICIO-GENERAL MANAGER

**PORT AUTHORITY OF GUAM  
Strategic Planning Division  
Routing Slip**

Date:

August 4, 2023

**SUBJECT: Account Creation under MARAD's FY2022 America's Marine Highway (AMH) Program Grant No. 693JF72340007**

Initial

Date

1. Joe G. Javellana III, Chief Planner

*[Handwritten Initials]*

8/4/23

2. Pacifico R. Martir, DGMA

*[Handwritten Initials]*

8/4/23

3. Jose B. Guevara III, Financial Affairs Controller

*[Handwritten Initials]*

8/4/23

4. Rory J. Respicio, General Manager

5.

6.

7.

8.

Action	File	Note and Return
<input checked="" type="checkbox"/> Approval	For Clearance	Per Conversation
<input type="checkbox"/> As Requested	For Correction	Prepare Reply
<input type="checkbox"/> Circulate	For Your Information	See Me
<input type="checkbox"/> Comment	Investigate	<input checked="" type="checkbox"/> Signature
<input type="checkbox"/> Coordination	Justify	

**REMARKS**

MARAD awarded \$9,332,831.00 for the acquisition of specialized container yard equipment; including, container handlers, forklifts, a boom lift, container yard tractors, and mobile reefer generators as part of the Guam Marine Transportation Enhancement Initiative.

The federal share of the project is \$5,703,560.00 (61%) and the PAG share is \$3,629,271.00 (39%).

**FROM:** Christopher Aguon

1026 CABRAS ISLAND HIGHWAY,

SUITE 201 PITI GUAM 96925

Phone No. ext. 295

Email: [cjaguon@portofguam.com](mailto:cjaguon@portofguam.com)



**PORT AUTHORITY OF GUAM**  
**ATURIDAT I PUETTON GUAHAN**  
 Jose D. Leon Guerrero Commercial Port  
 1026 Cabras Highway, Suite 201, Piti, Guam 96925  
 Telephone: (671) 477-5931/35 \* Facsimile: (671) 477-2689/4445  
 Website: [www.portguam.com](http://www.portguam.com)

August 4, 2023

**INTER-OFFICE MEMORANDUM**

TO: General Manager  
 Financial Affairs Controller

VIA: Deputy General Manager, Administration and Finance *pm*

FROM: Chief Planner *[Signature]*

SUBJECT: **Amendment - Account Creation under MARAD's FY2022 America's Marine Highway (AMH) Program Grant No. 693JF72340007**

*Hafa Adai!* The Port has been awarded the FY2022 Maritime Administration (MARAD) AMH Program for the project identified below. As an update to the draft grant agreement, MARAD amended the cost for equipment, as well as the PAG share and Total Cost for the project (see table below).

Project Title	PAG Cost-Match (39%)	Federal Share (61%)	Total Cost
Guam Marine Transportation Enhancement Initiative: Acquisition of Specialized Container Yard Equipment	\$3,629,271.00	\$5,703,560.00	\$9,332,831.00

In an effort to facilitate the grant process, I recommend to amend the account. The final grant agreement is provided to you for your file and dissemination. Should you have any questions or require additional information, please feel free to contact Joe Javellana or Christopher Aguon at extension 295.

APPROVED     DISAPPROVED     CONCUR     NONCONCUR

*Rory J. Respicio*

RORY J. RESPICIO, General Manager

*Jose B. Guevara*

JOSE B. GUEVARA, Financial Affairs Controller

Account #: C23F003.1782.1

Enclosures:  
 June 16, 2023 Inter-Office Memorandum – Account Creation under MARAD's FY2022 America's Marine Highway (AMH) Program Grant No. 693JF72340007  
 August 4, 2023 PAG-Signed Grant Agreement Under the Fiscal Year 2022 America's Marine Highway Program

**PORT AUTHORITY OF GUAM**  
**ATURIDAT I PUETTON GUAHAN**  
 Jose D. Leon Guerrero Commercial Port  
 1026 Cabras Highway, Suite 201, Piti, Guam 96925  
 Telephone: (671) 477-5931/35 \* Facsimile: (671) 477-2689/1115  
 Website: [www.jdgport.com](http://www.jdgport.com)

June 16, 2023

**INTER-OFFICE MEMORANDUM**

**TO:** General Manager  
 Acting Financial Affairs Controller *[Signature]*

**VIA:** Deputy General Manager, Operations *[Signature]*

**FROM:** Person-in-Charge *[Signature]*

**SUBJECT:** Account Creation under MARAD's FY2022 America's Marine Highway (AMH) Program  
 Grant No. 693JF72340007

*Hafa Adai!* The Port has been awarded the FY2022 Maritime Administration (MARAD) AMH Program for the project identified below. As MARAD finalizes the grant agreement, an establishment of account is needed for this award.

Project Title	PAG Cost-Match (22%)	Federal Share (78%)	Total Cost
Guam Marine Transportation Enhancement Initiative: Acquisition of Specialized Container Yard Equipment	\$1,609,140.00	\$5,703,560.00	\$7,312,700.00

In an effort to facilitate the grant process, I recommend the creation of the account. The draft grant agreement is provided to you for your file and dissemination. Should you have any questions or require additional information, please feel free to contact Joe Javellana or Christopher Aguon at extension 295.

APPROVED     DISAPPROVED     CONCUR     NONCONCUR

*[Signature]*  
 RORY J. RESPICIO, General Manager

*[Signature]* 6/16/2023  
 MARY J.G. CAMACHO, Acting Financial Affairs Controller

Account #: C21F003.1782.1 *6/16/23*

*Note. This amount needed by the Port is clearly understated and will be short, unless we have the authority to reduce the quantities of the yard equipment covered in this grant. This needs more work.*  
*Rory J. Respicio*

CC: Budget



**U.S. DEPARTMENT OF TRANSPORTATION  
MARITIME ADMINISTRATION**

**GRANT AGREEMENT UNDER THE  
FISCAL YEAR 2022 AMERICA'S MARINE HIGHWAY (AMH) PROGRAM**

MARAD FY 2022 AMH Grant No. 693JF72340007

70X1750S22 2023 1GM2340007 0000150000 41010 61006600 — \$2,122,385  
702232AMHG 2023 1GM2340007 0000150000 41010 61006600 — \$3,581,175

This agreement is between the United States Department of Transportation Maritime Administration (“MARAD”) and the Port Authority of Guam (the “Recipient”).

This agreement reflects the selection of the Recipient to receive an AMH Grant for the Guam Marine Transportation Enhancement Initiative.

The parties therefore agree to the following:

**ARTICLE 1  
GENERAL TERMS AND CONDITIONS**

**1.1 General Terms and Conditions.**

- (a) In this agreement, “General Terms and Conditions” means the content of the document titled “General Terms and Conditions Under the Fiscal Year 2022 America’s Marine Highway Program Grants,” dated December 2, 2022, which is available at <https://www.maritime.dot.gov/grants-finances/federal-grant-assistance/amh-2022-general-terms-and-conditions>. The General Terms and Conditions reference the information contained in the schedules to this agreement. The General Terms and Conditions are part of this agreement.
- (b) The Recipient states that it has knowledge of the General Terms and Conditions.
- (c) The Recipient acknowledges that the General Terms and Conditions impose obligations on the Recipient and that the Recipient’s non-compliance with the General Terms and Conditions may result in remedial action, terminating of the AMH Grant, disallowing costs incurred for the Project, requiring the Recipient to refund to MARAD the AMH Grant, and reporting the non-compliance in the Federal-government-wide integrity and performance system.

MAR-510  
W21-226  
Mailstop 3  
(202) 366-0586  
David.Bohnet@dot.gov

**6. Payment System.**

MARAD Payment System: Delphi eInvoicing System

**7. Office for Subaward and Contract Authorization.**

MARAD Office for Subaward and Contract Authorization: None

**8. Federal Award Identification Number.**

Federal Award Identification Number: 693JF72340007

**SCHEDULE B  
PROJECT ACTIVITIES**

- 1. General Project Description.**  
The Project will expand the Port's fleet of specialized container yard equipment. The equipment to be purchased includes two 40-ton loaded container handlers; three 10-ton empty container handlers; five 5.5-ton forklifts; one 180-foot boom lift; nine container yard tractor trailers; and two 40-plug mobile reefer generators.
- 2. Statement of Work.**  
The Project is for the purchase of equipment with the following specifications (or of similar specifications based on market availability):

**Two 40-Ton Loaded Container Handlers:**  
Lift Capacity – 80,000 lbs.  
Stacking Height – Must be able to stack 4-high of 9'6" ISO Container  
Engine – Diesel Tier III or better  
Spread – Open from 20'/40'/45'

**Three 10-Ton Empty Container Handlers:**  
Lift Capacity – 15,000 lbs.  
Stacking Height – Must be able to stack 4-high of 9'6" ISO Container  
Engine – Diesel Tier III or better  
Spreader – Single lift with vertical twist lock/open from 20'/40'/45'

**Five 5.5-Ton Forklifts:**  
Lift Capacity – 11,000 lbs.  
Height Lowered – Must be able to enter a standard 8'6" ISO Container  
Engine – Diesel Tier III or better  
Fork Adjustment – Side Shift individual and dual

**One 180-Ft. Boom Lift:**  
Platform Height – 180 ft.  
Platform Capacity (Restricted) – 1,000 lbs.  
Platform Capacity (Unrestricted) – 500 lbs.

**Nine Container Yard Tractor Trailers:**  
Engine – Diesel Tier IV  
Rear Axle: 42,000 lbs. minimum  
Front Axle: 12,000 lbs. minimum  
Fifth Wheel: 80,000 lbs. minimum  
Lifting Cylinders: Hydraulic, 63,000 lbs. minimum

**Two 40-Plug Mobile Reefer Generators:**  
Receptacle Plug Model – 40-plug
- 3. Documents Describing Mitigation Activities.**  
None.

Purchase of Three 10-Ton Empty Container Handlers End Date:	May 1, 2026
Purchase of Five 5.5-Ton Forklifts End Date:	May 1, 2026
Purchase of One 180-Ft. Boom Lift End Date:	May 1, 2026
Purchase of Nine Container Yard Tractor Trailers End Date:	May 1, 2026
Purchase of Two 40-Plug Mobile Reefer Generators End Date:	May 1, 2026
Planned Project Substantial Completion Date:	May 1, 2026

**3. Special Milestone Deadlines.**

Milestone	Schedule Date
PAG issues Purchase Order for Two 40-Ton Loaded Container Handlers:	October 31, 2024
PAG issues Purchase Order for Three 10-Ton Empty Container Handlers:	October 31, 2024
PAG issues Purchase Order for Five 5.5-Ton Forklifts:	October 31, 2024
PAG issues Purchase Order for One 180-Ft. Boom Lift:	October 31, 2024
PAG issues Purchase Order for Nine Container Yard Tractor Trailers:	October 31, 2024
PAG issues Purchase Order for Two 40-Plug Mobile Reefer Generators:	October 31, 2024

**4. Cost Classification Table.**

<b>Cost Classification</b>	<b>Total Costs</b>	<b>Non-AMH Previously Incurred Costs</b>	<b>Eligible Costs</b>
Administrative and legal expenses	\$47,000		\$47,000
Equipment	\$9,285,831		\$9,285,831
<b>Project Total</b>	<b>\$9,332,831</b>		<b>\$9,332,831</b>

**5. Approved Pre-award Costs**

**None.** MARAD has not approved under this award any pre-award costs under 2 C.F.R. 200.458. Because unapproved costs incurred before the date of this agreement are not allowable costs under this award, MARAD will neither reimburse those costs under this award nor consider them as a non-Federal cost sharing contribution to this award. Costs incurred before the date of this agreement are allowable costs under this award only if approved in writing by MARAD before being included in the Project costs and documented in this section 5. See section 13.3(b) of the General Terms and Conditions.

**SCHEDULE F  
AMH PROGRAM DESIGNATIONS**

**1. Urban or Rural Designation.**

Urban-Rural Designation: Rural

**2. Capital or Planning Designation.**

Capital-Planning Designation: Capital

**3. Historically Disadvantaged Community Designation.**

HDC Designation: Yes

**4. Funding Act.**

IIJA	\$3,581,175
FY2022	\$2,122,385

**RECIPIENT SIGNATURE PAGE**

The Recipient, intending to be legally bound, is signing this agreement on the date stated opposite that party's signature.

**PORT AUTHORITY OF GUAM**

August 4, 2023 By:   
Date Signature of Recipient's Authorized Representative  
Rory J. Respicio  
Name  
General Manager  
Title







## TRANSMITTAL OF PLANNING PROCUREMENT RECORD TO GSA

**Instructions:** After ascertaining the statement's accuracy and truthfulness, the agency's (director or head of agency) must sign the Certification below to indicate that the agency has kept and will keep a complete procurement record of all documents required by law as to its planning of the procurement; and is in fact transmitting a full and complete record of the planning of the procurement to GSA in accompaniment with this transmittal form as of the date this form is signed.

**Requesting/Using Agency:** Port Authority of Guam

**Re:** Telescopic Boom Lift, 180' feet Reach Full time 4WD

### 5 GCA §5249 Record of Procurement Actions

Each procurement officer shall maintain a complete record of each procurement. The record shall include the following:

- (a) the date, time, subject matter and names of participants at any meeting including government employees that is in any way related to a particular procurement;
- (b) a log of all communications between government employees and any member of the public, potential bidder, vendor or manufacturer which is in any way related to the procurement;
- (c) sound recordings of all pre-bid conferences; negotiations arising from a request for proposals and discussions with vendors concerning small purchase procurement;
- (d) brochures and submittals of potential vendors, manufacturers or contractors, and all drafts, signed and dated by the draftsman, and other papers or materials used in the development of specifications; and
- (e) the requesting agency's determination of need.

### 5 GCA §5132. Retention of Electronic Mail Correspondences

All incoming and outgoing electronic mail (email) correspondences pertaining to matters related to the procurement of goods and services as governed by this Chapter shall be retained for a period of not less than five (5) years. Such electronic mail (email) correspondences may be used for evidentiary purposes in the appellate procedures contained in this Chapter.

### 5 GCA § 10102 (d). Definition of Public Records

Public Records includes any writing containing information relating to the conduct of public business prepared, owned, used, or retained by any state or local agency in any format, including in electronic format.

The specifications for this procurement were prepared by Joaquin P. Pangelinan in keeping with the above and all applicable Guam Procurement Laws and Regulations; and, he/she/they have included all records, meeting notes and any other materials in their/its possession in developing the specifications/statement of work/scope of services/technical specification as well as any of the above procurement records items. Additionally included is the written determination of need of the need the agency for this procurement (signed by director or head of the agency) and if applicable the board or commission minutes of the approval of this procurement. Please include research as to the availability of services, market availability. In the event this procurement is funded in whole or in part with federal funds a copy of the notice of grant award and any required federal terms and conditions or forms.

**CERTIFICATION:** I hereby certify under penalty of perjury that I am responsible for the planning procurement record and I have caused to be prepared and now transmit a full and complete record of the planning procurement records as required by law. I have obtained the signed verification of all individuals involved as the preparation of the specification that this is a true and accurate statement, and that this transmittal to GSA is complete. I acknowledge that there are continuing responsibilities within the requesting/using agency as to public records related to this procurement and will make sure they are maintained as required above.

Signature: 

Print Name: Joaquin P. Pangelinan

Date: Oct 24, 23

## DETERMINATION OF NEED

### 180' Boom Lift

The Port Authority of Guam operates the only commercial seaport on Territory and as the primary seaport in Micronesia, serves as a transshipment port for the entire Western Pacific Region. It operates the largest U.S. deep water seaport in the Western Pacific Region and currently handles over 2 million tons of cargo a year. The Port owns, operates and maintains various cargo handling equipment to move cargoes and to support the maintenance of other cargo handling equipment's.

The Port Authority of Guam's Maintenance Department requires a 180-foot boom lift for various types of maintenance. This is the only possible way for Facility Maintenance to repair all high mast lighting for the entire terminal yard. The lift provides maintenance to access unreachable areas on our 3 Gantry Cranes for any corrosion and welding repairs. Without the ability to conduct such repairs would reduce the life span of our already aging cranes and cause significant safety concerns.



---

Rory J. Resepcio, General Manager



---

Date

## Denise

---

**From:** Raymond Bamba <Raymond.Bamba@gsadoa.guam.gov>  
**Sent:** Tuesday, November 07, 2023 8:27 AM  
**To:** Denise  
**Subject:** RE: Tenda Availability 180 Boom Lift Bid

Hi Denise,

This item is unavailable.

Ray

---

**From:** Denise <djcalvo@portofguam.com>  
**Sent:** Monday, November 6, 2023 4:16 PM  
**To:** Raymond Bamba <Raymond.Bamba@gsadoa.guam.gov>  
**Cc:** 'PAG Procurement' <pagprocurement@portofguam.com>  
**Subject:** Tenda Availability 180 Boom Lift Bid

**CAUTION:** This email originated from outside of the Government's Network. Do not click links or open attachments unless you recognize the sender and know the content is safe.

H Hi Mr. Ray,

I hope all is well. Please let me know if the attached bid line items are available in Tenda.  
Please see the file attached.

If you have any questions, please let me know.

Thank you,

Denise

8b



**PORT OF GUAM**  
 ATURIDAT I PUETTON GUAHAN  
 Jose D. Leon Guerrero Commercial Port  
 1026 Cabras Highway, Suite 201, Piti, Guam 96915  
 Telephone: 671-477-5931/35 Facsimile: 671-477-2689/4445  
 Website: www.portguam.com



Lourdes A. Leon Guerrero  
 Governor of Guam  
 Joshua F. Tenorio  
 Lieutenant Governor

**AMENDMENT NO. 1**

DATE: February 14, 2024

**INVITATION FOR BID No. PAG-004-24**  
**180' Telescopic Boom Lift**

**NOTICE TO OFFERORS:** The IFB documents of the above referenced project are hereby amended to include the following as part of IFB documents:

Amend to change on page 48 of 68 under deliver **TO READ FROM:** The successful bidder shall deliver one(1) 180' Boom Lift each be new fully assembled and ready for operation to the Port Authority of Guam within 120 days **TO NOW READ:** The successful bidder shall deliver one(1) 180' Boom Lift fully assembled and ready for operation to the Port Authority of Guam within 460 days.

**\*\*\* END OF AMENDMENT NO. 1, ALL OTHERS REMAIN THE SAME \*\*\***

Issued by:

Rory J. Respicio  
 General Manager

NAME OF OFFEROR: \_\_\_\_\_

AUTHORIZED SIGNATURE: \_\_\_\_\_

PRINT NAME: \_\_\_\_\_

DATE/ TIME: \_\_\_\_\_



**PORT OF GUAM**  
**ATURIDAT I PUETTON GUAHAN**  
**Jose D. Leon Guerrero Commercial Port**  
 1026 Cabras Highway, Suite 201, Piti, Guam 96915  
 Telephone: 671-477-5931/35 Facsimile: 671-477-2689/4445  
 Website: [www.portguam.com](http://www.portguam.com)



**Lourdes A. Leon Guerrero**  
 Governor of Guam  
**Joshua F. Tenorio**  
 Lieutenant Governor

February 14, 2024

**INVITATION FOR BID IFB-PAG-004-24**  
**180' Telescopic Boom Lift**  
**Questions and Responses**

Question submitted by Far East Equipment via e-mail on January 30, 2024

**Question #1:** Would a boom truck with a working height of 182'11" be acceptable in lieu of a telescopic boom lift? We recommend this option due to the greater versatility and mobility it can offer.

**PAG's Response:** No. The equipment indicated is approved as specified by the Federal Grantor

Question submitted by Morrico Equipment via e-mail on February 9, 2024

**Question #1:** Delivery Date a. IFB-PAG-004-24 Page 3 of 68 "Invitation for Bid": i. Required Delivery Date: (460 days ARO) upon receipt of purchase order. b. IFB-PAG-004-24 Page 48 of 68 "Deliver:" i. The successful bidder shall deliver one (1) 180' Boom Lift each be new fully assembled and ready for operation to the Port Authority of Guam within 120 days. - Morrico requests the delivery date is confirmed at 460 day ARO due to advised manufacturing schedules.

**PAG's Response:** See Amendment #1

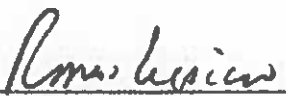
  
 \_\_\_\_\_  
 Rory J. Respicio  
 General Manager

<b>ACKNOWLEDGEMENT</b>
NAME: _____
COMPANY: _____
DATE/TIME: _____





---

**Amendment No. 1 and Questions & Concerns IFB-PAG-004-24 180' Telescopic Boom Lift**

---

**From :** Mark A. Cabrera <macabrera@portofguam.com> Thu, Feb 15, 2024 03:35 PM  
**Subject :** Amendment No. 1 and Questions & Concerns IFB-PAG-004-24 180' Telescopic Boom Lift  3 attachments  
**To :** algsablan <algsablan@portofguam.com>  
**Cc :** PAG Procurement <pagprocurement@portofguam.com>  
**Bcc :** Ryne Santos <rsantos@fareastequipment.com>, fleetsales@triplejguam.com, wrp07@msn.com, doc <doc.b@docbaileycranes.com>, Patrick Chargualaf <Patrick@morricoequipment.com>, lacee guerrero <lacee.guerrero@pfmguam.com>

Hafa Adai All Bidders,

Please acknowledge by signing and returning each of the attachments.

Thank You,

Mark A. Cabrera  
Procurement Buyer Supervisor



Port Authority of Guam  
1026 Cabras Highway  
Suite 201 Piti GU 96915  
(671)477-5931 ext. 252  
macabrera@portofguam.com



 **Amendment No. 1 IFB-PAG-004-24.pdf**  
44 KB





**PORT OF GUAM**  
 ATURIDAT I PUETTON GUAHAN  
 Jose D. Leon Guerrero Commercial Port  
 1026 Cabras Highway, Suite 201, Piti, Guam 96915  
 Telephone: 671-477-5931/35 Facsimile: 671-477-2689/4445  
 Website: [www.portguam.com](http://www.portguam.com)



Lourdes A. Leon Guerrero  
 Governor of Guam  
 Joshua F. Tenorio  
 Lieutenant Governor

February 14, 2024

**INVITATION FOR BID IFB-PAG-004-24**  
**180' Telescopic Boom Lift**  
**Questions and Responses**

Question submitted by Far East Equipment via e-mail on January 30, 2024

Question #1: Would a boom truck with a working height of 182'11" be acceptable in lieu of a telescopic boom lift? We recommend this option due to the greater versatility and mobility it can offer.

PAG's Response: No. The equipment indicated is approved as specified by the Federal Grantor

Question submitted by Morrico Equipment via e-mail on February 9, 2024

Question #1: Delivery Date a. IFB-PAG-004-24 Page 3 of 68 "Invitation for Bid": i. Required Delivery Date: (460 days ARO) upon receipt of purchase order. b. IFB-PAG-004-24 Page 48 of 68 "Deliver:" i. The successful bidder shall deliver one (1) 180' Boom Lift each be new fully assembled and ready for operation to the Port Authority of Guam within 120 days. - Morrico requests the delivery date is confirmed at 460 day ARO due to advised manufacturing schedules.

PAG's Response: See Amendment #1

Rory J. Respicio  
 General Manager

ACKNOWLEDGEMENT
NAME: <u>Patrick Chargualaf</u>
COMPANY: <u>Morrice Equipment LLC</u>
DATE/TIME: <u>02/15/2024 @ 4:14 PM</u>