



Jerrick Hernandez <jhernandez@guamopa.com>

E-Filing: OPA-PA-24-001; Guam Solid Waste Authority Procurement Record

GSWA Admin <admin@gswa.guam.gov>

Mon, May 6, 2024 at 3:39 PM

To: Jerrick Hernandez <jhernandez@guamopa.com>

Cc: Irvin Slike <irvin.slike@gswa.guam.gov>, shannon@camachotaitano.law

Hafa adai,

GSWA is re-submitting the Procurement Record for Invitation for Bid # GSWA-004-24. We have identified an error in the original submission, specifically Tab 2, pages 7-40 of the procurement record. We have made the corrections and are hereby submitting the corrected file attached.

Please let me know if there's any further action required.

Thank you.

[Quoted text hidden]



OPA-PA-24-001 GSWA PROCUREMENT RECORD (Corrected).pdf

18628K

**IN THE OFFICE OF PUBLIC ACCOUNTABILITY
PROCUREMENT APPEAL**

IN THE APPEAL OF:)	DOCKET NO. OPA-PA-24-001
MORRICO EQUIPMENT, LLC,)	
)	
Appellant,)	PROCUREMENT RECORD OF
)	PURCHASING AGENCY
AND)	
GUAM SOLID WASTE AUTHORITY,)	
)	
Purchasing Agency.)	

Submitted this 30th day of April 2023.

GUAM SOLID WASTE AUTHORITY

By: _____



IRVIN SLIKE
General Manager



**PROCUREMENT RECORD
INVITATION FOR BID NO. GSWA-004-24
COMPACT WHEEL LOADER WITH ATTACHMENTS**

TABLE OF CONTENTS

CERTIFICATION OF COMPLETED PROCUREMENT RECORD.....	3
PUBLISHED NOTICE	4
PROCUREMENT PACKAGE	6
PROCUREMENT PACKAGE DISTRIBUTION LOG	41
AMENDMENTS	46
AMENDMENT DISTRIBUTION LOG	53
PRE-SUBMISSION CONFERENCE MINUTES	72
PRE-SUBMISSION CONFERENCE ATTENDANCE LOG	73
WRITTEN QUESTIONS	74
WRITTEN ANSWERS	80
PROOF OF WRITTEN ANSWERS PROVIDED TO BIDDERS.....	85
BID SUBMISSION LOG.....	102
COPY OF BIDS RECEIVED.....	104
BID ANALYSIS.....	245
BID ABSTRACT.....	248
BID STATUS.....	251
MEMORANDUM OF EVALUATIONS & NEGOTIATIONS	254
NOTICE OF INTENT OF POSSIBLE AWARD.....	255
COMMUNICATIONS	258
CONTRACT.....	388
PROTESTS	462
DETERMINATION OF NEED	470

CERTIFICATION of COMPLETED PROCUREMENT RECORD

Instructions: After ascertaining the statement's accuracy and truthfulness, the agency's procurement officer (director or head of agency) must sign the Certification below to indicate that the agency has kept a complete procurement record of all documents required by law. The checklist below is provided to ensure that the record is complete, and must be filled out by the procurement officer or administrator. The checklist is comprised of every item that is required by law for an invitation for bid (IFB) or a request for proposal (RFP), and therefore every item, except as noted below, must be checked for the resulting contract to be considered legally sufficient. Please assemble the procurement record in the order stated below and place it in a three-ring binder, with visible tabs for each of the items below appearing in numerical order.

IFB/RFP No: GSWA-004-24 Contractor: PAR EAST EQUIPMENT COMPANY, LLC

COMPACT WHEEL LOADER W/ ATTACHMENTS

- 1. Published notice in newspaper of general circulation
- 2. Procurement package (IFB or RFP) issued to bidders or offerors
- 3. Log of distribution of procurement package
- 4. Amendments to IFB or RFP, if any were issued
- 5. Logs of distribution of amendments to IFB or RFP, but only if amendments were issued
- N/A 6. Minutes or summary of pre-submission conferences, but only if conferences were held
- N/A 7. Logs of attendees of pre-submission conferences, but only if conferences were held
- 8. Written questions from bidders or offerors, but only if any questions were received
- 9. Written answers, but only if any questions were received
- 10. Proof that written answers were provided to all potential bidders or offerors, but only if any questions were received
- 11. Log of bids or registry of proposals received
- 12. Each bid or proposal received
- 13. Evaluation of proposals or analysis of bids (bids are not required by law to be analyzed, but may be)
- 14. Tabulation of evaluations or analysis (tabulations are not required by law but recommended)
- 15. Letters to bidders concerning outcome of bid; for offerors, letters informing them of ranking and letter to best qualified offeror inviting negotiations
- N/A 16. Memorandum of evaluations and negotiations (only required for RFP's)
- 17. Notice of intent to award
- 18. Any and all communications from or to anyone concerning any part of IFB or RFP
- 19. Contract, including all draft versions
- 20. Bid protests, if any, and responses thereto
- 21. Any determination required by law as may fit the circumstances

CERTIFICATION: Pursuant to 5 G.C.A. §5250, I hereby certify under penalty of perjury that I am the procurement officer responsible for administering the solicitation of the acquisition referenced above, and that I have caused to be prepared and now maintain a full and complete record of the procurement as required by law.

Signature: 
 Print Name: MR. IRVIN L. SLIKE Date: 4/26/24

NEWSPAPER ADVERTISEMENT

We are looking for people with

DRIVE

Multiple routes available!

Great supplemental income!

Make extra cash

in a few hours a day!

Perfect for night owls!



Interested?
Send us an email!
krista@postguam.com
or
marc@postguam.com

DAILY POST

PUBLICATION NOTICE

In accordance with the provisions of Guam Code Annotated, Title XI, Chapter III, Section 3315, notice is hereby given that:

JEM Company LTD (TAKEOVER) DBA : Mangilao Mobil

has applied for a Class: 5 (FIVE) GENERAL OFF SALE Alcoholic Beverage License said premises being marked as Lot: 2427-3-5R-NEW-1 #493 SOUTH ROUTE 10 MANGILAO



Guam Solid Waste Authority

546 N. Marine Corps Dr., Tamuning, Guam 96913

INVITATION FOR BID (IFB)

Bid No: GSWA-004-24
For: Compact Wheel Loader
Bid Opening Date: Monday, November 20, 2023
Time: 1:00 p.m. ChST
Location: Guam Solid Waste Authority, 2nd Floor

Bid packages may be picked up at Guam Solid Waste Authority, 546 N. Marine Corps Dr. in Upper Tumon, 2nd Floor, beginning Friday, November 3, 2023 until Monday, November 20, 2023, or visit the GSWA website <http://www.guamsolidwasteauthority.com> to obtain an electronic copy of the IFB.

For more information, please contact Alicia Fejeran, Chief of Administration, at 671-646-3111.

This advertisement was paid for by GSWA.



WE ARE LOOKING FOR NEW MEMBERS TO GROW TOGETHER!

ASSISTANT PROPERTY MANAGER
PROPERTY MANAGEMENT
MAINTENANCE STAFF
PROGRAM COORDINATOR
ADMIN STAFF/ASSISTANT
MAINTENANCE HELPER
HOUSEKEEPER
GARDENER

ADMIN TRAINEE FOR ASSISTANT
OR PROPERTY MANAGER
MAINTENANCE STAFF
HOUSEKEEPER
RUNNER

MECHANIC/MECHANIC HELPER
WELDER/WELDER HELPER
OPERATIONS MANAGER
GENERAL HELPER
DRIVER

QUALITY CONTROL MANAGER
SR MECHANICAL ENGINEER
TRAILER TRUCK OPERATOR
ADMINISTRATIVE RUNNER
CONCRETE MIXER DRIVER
HR & ADMIN ASSISTANT
PROPOSAL WRITER
SUPERINTENDENT
HOUSEKEEPER



admin@gffi.net
(671) 486-4862



admin@ctdevelop.com
(671) 486-3161



admin@laguam.com
(671) 649-5681



main@coretechintl.com
(671) 473-5000



PROCUREMENT PACKAGE



GUAM SOLID WASTE AUTHORITY

LOURDES A. LEON GUERRERO
Governor of Guam

JOSHUA F. TENORIO
Lt. Governor of Guam

IRVIN L. SLIKE
General Manager



INVITATION FOR BID NO.: GSWA-004-24

DESCRIPTION: COMPACT WHEEL LOADER W/ ATTACHMENTS

SPECIAL REMINDER TO PROSPECTIVE BIDDERS

Bidders are reminded to read the Sealed Bid Solicitation and Instructions, and General Terms and Conditions attached to the IFB to ascertain that all of the following requirements checked below are submitted in the bid envelope, in duplicate, and the date and time for bid opening.

- (X) **BID GUARANTEE (15% of Bid Amount) May be in the form of;**
Reference #11 on the General Terms and Conditions
 - a. Cashier’s Check or Certified Check
 - b. Letter of Credit
 - c. Surety Bond – Valid only if accompanied by:
 - 1. Current Certificate of Authority issued by the Insurance Commissioner;
 - 2. Power of Attorney issued by the Surety to the Resident General Agent;
 - 3. Power of Attorney issued by two (2) major officers of the Surety to whoever is signing on their behalf.

- (X) **BROCHURES/DESCRIPTIVE LITERATURE;**

- (X) **AFFIDAVIT DISCLOSING OWNERSHIP, INFLUENCE, COMMISSION, & CONFLICT OF INTEREST**
 - a. Date of signature of the person authorize to sign the bid and the notary date must be the same.

- (X) **OTHER REQUIREMENTS:**
Affidavit re Non-Collusion, Affidavit re No Gratuities or Kickbacks, Affidavit re Ethical Standards, Affidavit D.O.L. Wage Determination, Affidavit re Contingent Fees, Special Provision; Restriction Against Sexual Offenders

- (X) **CURRENT BUSINESS LICENSE / CONTRACTOR’S LICENSE / SPECIALTY LICENSE**
IN REFERENCE TO SUPPLIES OR SERVICES FOR THIS BID

This reminder must be signed and returned in the bid envelope together with the bid. Failure to comply with the above requirements may be cause for disqualification and rejection of bid.

On this _____ day of _____, 2023, I _____, authorized representative of _____ acknowledge receipt of this special reminder to prospective bidders with the above referenced IFB.

Bidder Representative’s Signature



GUAM SOLID WASTE AUTHORITY

LOURDES A. LEON GUERRERO
Governor of Guam

JOSHUA F. TENORIO
Lt. Governor of Guam

IRVIN L. SLIKE
General Manager



INVITATION FOR BID

ISSUING OFFICE:

IRVIN L. SLIKE
General Manager

10/31/23
DATE

GUAM SOLID WASTE AUTHORITY
546 NORTH MARINE CORPS DRIVE
TAMUNING, GUAM 96913

DATE ISSUED: 11/03/2023
BID INVITATION NO.: GSWA-004-24
BID FOR: COMPACT WHEEL LOADER W/ ATTACHMENTS
SPECIFICATION: SEE ATTACHED
DESTINATION: GUAM SOLID WASTE AUTHORITY
REQUIRED DELIVERY DATE: 200 DAYS UPON RECEIPT OF PURCHASE ORDER

INSTRUCTIONS TO BIDDERS:

INDICATE WHETHER: INDIVIDUAL PARTNERSHIP CORPORATION
INCORPORATED IN: _____

This bid shall be submitted in duplicate and sealed to the issuing office no later than (Time) **1:00PM**,
Date: 11/20/2023, and shall be publicly opened. Bid submitted after the time and date specified above shall be rejected.
See attached General Terms and Conditions and Sealed Bid Solicitation for details.

The undersigned offers and agrees to furnish within the time specified, the articles and services at the price stated opposite the respective items listed on the schedule provided, unless otherwise specified by the bidder. In consideration to the expense of the Government in opening, tabulating, and evaluating this and other bids, and other considerations, the undersigned agrees that this bid remain firm and irrevocable within one hundred twenty (120) calendar days from the date opening to supply any or all the items which prices are quoted.

NAME AND ADDRESS OF BIDDER:

SIGNATURE AND TITLE OF PERSON
AUTHORIZED TO SIGN THIS BID:

AWARD: CONTRACT NO.: _____ AMOUNT: _____ DATE: _____

ITEM NO(S). AWARDED: _____

CONTRACTING OFFICER:

IRVIN L. SLIKE DATE
General Manager

NAME AND ADDRESS OF CONTRACTOR:

SIGNATURE AND TITLE OF PERSON
AUTHORIZED TO SIGN THIS CONTRACT:

**AFFIDAVIT DISCLOSING OWNERSHIP, INFLUENCE, COMMISSIONS AND
CONFLICTS OF INTEREST**

(Required by 5 GCA § 5233 as amended by P.L. 36-13 (4/9/2021))

CITY OF _____)
) ss.
 ISLAND OF GUAM)

Preface. As a condition of submitting a Bid/Offer/Proposal or responding to any method of source selection under Guam’s Procurement Law for the purpose of entering into a contract with the government of Guam, this Affidavit requires all Bidders/Offerors/Prospective Contractors to make disclosures of ownership, influence, commissions, gratuities, kickbacks, and conflicts of interest occurring **during the 365 calendar days preceding the publication of this solicitation and until award of a contract**. This includes the duty to disclose **any changes** to the facts disclosed herein throughout the solicitation process; and if the entity submitting this Affidavit is awarded a contract, the duty to disclose **any changes** to the facts disclosed herein **continues throughout the life of the contract, including any extensions or renewals**.

A. I, the undersigned, being first duly sworn, depose and say that I am an authorized representative of the Bidder/Offeror/Prospective Contractor and that (please check and fill out all that apply):

The Bidder/Offeror/Prospective Contractor is an individual with a business license, and all decisions are by, and all profit is for, that same individual, with principal place of business street address being: _____

The Bidder/Offeror/Prospective Contractor is a business or artificial person (as defined in 1 GCA § 715 or 5 GCA §§ 5030(n) or 5233(b)), and is a sole proprietorship owned entirely (100%) by _____, with principal place of business street address being: _____

The Bidder/Offeror/Prospective Contractor is a business or artificial person (as defined in 1 GCA § 715 or 5 GCA §§ 5030(n) or 5233(b)), and is owned by the following multiple individuals. Note: owners of more than 10% are statutorily required to be listed below, but other owners of smaller percentage are encouraged to be listed as well.

Name of Owner	Principal Place of Business Street Address	% of Interest
_____	_____	_____
_____	_____	_____
_____	_____	_____
_____	_____	_____

Affidavit Disclosing Ownership, Influence,
 Commissions and Conflicts of Interest
 AG Procurement Form 002 (Rev. 11/17/2021)

[] One or more of the more-than-10% owners listed above is a business or artificial person. Any more-than-25% owners of such a business or artificial person are listed below per 5 GCA § 5233. Note: any less-than-25% owners of such a business or artificial person is encouraged to also be listed below.

Name of >10% Owner Business or Artificial Person:

--

Names of owners of the >10% Owner Business or Artificial Person (“Second Tier Owner”)	Owner’s Principal Place of Business Street Address	% of Interest

Name of other >10% Owner Business or Artificial Person:

--

Names of owners of the >10% Owner Business or Artificial Person (“Second Tier Owner”)	Owner’s Principal Place of Business Street Address	% of Interest

B. If any Second Tier Owner identified above is an artificial person, the natural or artificial owners of such Second Tier Owner who have held more than 49% of the shares or interest in the Bidder/Offeror/Prospective Contractor (Third Tier Owners) are as follows [if none, please so state]:

Second Tier Owner Name _____

Name of Third Tier Owner	Principal Place of Business Street Address	% of Interest
_____	_____	_____
_____	_____	_____
_____	_____	_____
_____	_____	_____

Affidavit Disclosing Ownership, Influence,
 Commissions and Conflicts of Interest
 AG Procurement Form 002 (Rev. 11/17/2021)

C. If the name of no natural person has been identified as an owner, or a Second or Third Tier Owner of the Bidder/Offeror/Prospective Contractor, please identify the name, position, address, and contact information of the natural person having the authority and responsibility for the Bid/Offer/Proposal/Prospective Contract, and the name of any natural person who has the authority and power to remove and replace the designated responsible person:

Name of Natural Person	Position	Street Address of Principal Place of Business	Phone Number, Email Address, and other Contact Information

D. Further, I say that the persons who have received or are entitled to receive a commission, gratuity, contingent fee or other compensation to solicit, secure, or assist in obtaining business related to the Bid/Offer/Proposal/Prospective Contract for which this Affidavit is submitted are as follows (if none, please so state):

Name	Principal Place of Business Street Address	Amount of Compensation
_____	_____	_____
_____	_____	_____

E. Further, I say that the persons who have directly or indirectly participated in this solicitation and who are also employees of the government of Guam or the government of the United States, if federal funds are to be used in the payment of the contract related to the Bid/Offer/Proposal/Prospective Contract for which this Affidavit is submitted, are as follows (if none, please so state):

Name	Principal Place of Business Street Address
_____	_____
_____	_____

F. Regardless of any ownership interest, the following individuals have the power to control the performance of the contract or to control the Bidder/Offeror/Prospective Contractor, directly or indirectly:

Name	Principal Place of Business Street Address
_____	_____
_____	_____

///

///

Affidavit Disclosing Ownership, Influence,
Commissions and Conflicts of Interest
AG Procurement Form 002 (Rev. 11/17/2021)

G. Until award of the contract, and throughout the term of any contract awarded to the Bidder/Offeror/Prospective Contractor represented herein, I agree to promptly make any disclosures not made previously and update changes in ownership, identities of owners and other required information, interests, compensation or conflicts of the persons required to be disclosed. I understand that failure to comply with this requirement shall constitute a material breach of contract.

H. I hereby declare under penalty of perjury under the laws of Guam that the foregoing is true and correct.

Executed on: _____
(date)

Signature of one of the following:
Bidder/Offeror/Prospective Contractor, if a licensed individual
Owner of sole proprietorship Bidder/Offeror/Prospective
Contractor
Partner, if the Bidder/Offeror/Prospective Contractor is a
partnership
Officer, if the Bidder/Offeror/Prospective Contractor is a
corporation

Subscribed and sworn to before me

This ____ day of _____, 20 ____.

NOTARY PUBLIC
My commission expires: _____

DECLARATION RE COMPLIANCE WITH U.S. DOL WAGE DETERMINATION

Procurement No.: _____

Name of Offeror Company: _____

I, _____ hereby **certify under penalty of perjury:**

(1) That I am _____ [*please select one: the offeror, a partner of the offeror, an officer of the offeror*] making the bid or proposal in the foregoing identified procurement;

(2) That I have read and understand the provisions of 5 GCA § 5801 and § 5802 which read:

§ 5801. Wage Determination Established.

In such cases where the government of Guam enters into contractual arrangements with a sole proprietorship, a partnership or a corporation ("contractor") for the provision of a service to the government of Guam, and in such cases where the contractor employs a person(s) whose purpose, in whole or in part, is the direct delivery of service contracted by the government of Guam, then the contractor shall pay such employee(s) in accordance with the Wage Determination for Guam and the Northern Mariana Islands issued and promulgated by the U.S. Department of Labor for such labor as is employed in the direct delivery of contract deliverables to the government of Guam.

The Wage Determination most recently issued by the U.S. Department of Labor at the time a contract is awarded to a contractor by the government of Guam shall be used to determine wages, which shall be paid to employees pursuant to this Article. Should any contract contain a renewal clause, then at the time of renewal adjustments, there shall be made stipulations contained in that contract for applying the Wage Determination, as required by this Article, so that the Wage Determination promulgated by the U.S. Department of Labor on a date most recent to the renewal date shall apply.

§ 5802. Benefits.

In addition to the Wage Determination detailed in this Article, any contract to which this Article applies shall also contain provisions mandating health and similar benefits for employees covered by this Article, such benefits having a minimum value as detailed in the Wage Determination issued and promulgated by the U.S. Department of Labor, and shall contain provisions guaranteeing a minimum of ten (10) paid holidays per annum per employee.

(3) That the offeror is in full compliance with 5 GCA § 5801 and § 5802, as may be applicable to the procurement referenced herein;

(4) That I have attached the most recent wage determination applicable to Guam issued by the U.S. Department of Labor. [*INSTRUCTIONS - Please attach!*]

Signature

"REGISTER OF WAGE DETERMINATIONS UNDER THE SERVICE CONTRACT ACT By direction of the Secretary of Labor	U.S. DEPARTMENT OF LABOR EMPLOYMENT STANDARDS ADMINISTRATION WAGE AND HOUR DIVISION WASHINGTON D.C. 20210 Wage Determination No.: 2015-5693 Revision No.: 19 Date Of Last Revision: 07/17/2023
Daniel W. Simms Director	Division of Wage Determinations

Note: Contracts subject to the Service Contract Act are generally required to pay at least the applicable minimum wage rate required under Executive Order 14026.

If the contract is entered into on or after January 30, 2022, or the contract is renewed or extended (e.g., an option is exercised) on or after January 30, 2022:	Executive Order 14026 generally applies to the contract. The contractor must pay all covered workers at least \$16.20 per hour (or the applicable wage rate listed on this wage determination, if it is higher) for all hours spent performing on the contract in 2023.
---	--

The applicable Executive Order minimum wage rate will be adjusted annually. Additional information on contractor requirements and worker protections under the Executive Orders is available at www.dol.gov/whd/govcontracts.

States: Guam, Northern Marianas, Wake Island

Area: Guam Statewide
 Northern Marianas Statewide
 Wake Island Statewide

****Fringe Benefits Required Follow the Occupational Listing****

OCCUPATION CODE - TITLE	FOOTNOTE	RATE
01000 - Administrative Support And Clerical Occupations		
01011 - Accounting Clerk I		14.27***
01012 - Accounting Clerk II		16.02***
01013 - Accounting Clerk III		17.93
01020 - Administrative Assistant		21.43
01035 - Court Reporter		17.40
01041 - Customer Service Representative I		12.75***
01042 - Customer Service Representative II		14.23***
01043 - Customer Service Representative III		15.62***
01051 - Data Entry Operator I		12.16***
01052 - Data Entry Operator II		13.27***
01060 - Dispatcher, Motor Vehicle		17.39
01070 - Document Preparation Clerk		13.85***
01090 - Duplicating Machine Operator		13.85***
01111 - General Clerk I		11.33***
01112 - General Clerk II		12.36***
01113 - General Clerk III		13.88***
01120 - Housing Referral Assistant		19.39
01141 - Messenger Courier		11.37***
01191 - Order Clerk I		12.57***
01192 - Order Clerk II		13.71***
01261 - Personnel Assistant (Employment) I		15.95***
01262 - Personnel Assistant (Employment) II		17.85
01263 - Personnel Assistant (Employment) III		19.89
01270 - Production Control Clerk		22.97
01290 - Rental Clerk		11.10***
01300 - Scheduler, Maintenance		15.55***
01311 - Secretary I		15.55***
01312 - Secretary II		17.40
01313 - Secretary III		19.39
01320 - Service Order Dispatcher		15.40***
01410 - Supply Technician		21.43
01420 - Survey Worker		16.96
01460 - Switchboard Operator/Receptionist		10.78***
01531 - Travel Clerk I		13.01***
01532 - Travel Clerk II		14.12***
01533 - Travel Clerk III		15.09***
01611 - Word Processor I		14.53***

01612 - Word Processor II	16.31
01613 - Word Processor III	18.26
05000 - Automotive Service Occupations	
05005 - Automobile Body Repairer, Fiberglass	17.20
05010 - Automotive Electrician	16.16***
05040 - Automotive Glass Installer	15.11***
05070 - Automotive Worker	15.11***
05110 - Mobile Equipment Servicer	12.96***
05130 - Motor Equipment Metal Mechanic	17.20
05160 - Motor Equipment Metal Worker	15.11***
05190 - Motor Vehicle Mechanic	17.20
05220 - Motor Vehicle Mechanic Helper	11.87***
05250 - Motor Vehicle Upholstery Worker	14.06***
05280 - Motor Vehicle Wrecker	15.11***
05310 - Painter, Automotive	16.16***
05340 - Radiator Repair Specialist	15.11***
05370 - Tire Repairer	12.67***
05400 - Transmission Repair Specialist	17.20
07000 - Food Preparation And Service Occupations	
07010 - Baker	11.10***
07041 - Cook I	14.44***
07042 - Cook II	16.84
07070 - Dishwasher	9.69***
07130 - Food Service Worker	10.11***
07210 - Meat Cutter	13.34***
07260 - Waiter/Waitress	9.73***
09000 - Furniture Maintenance And Repair Occupations	
09010 - Electrostatic Spray Painter	18.75
09040 - Furniture Handler	11.37***
09080 - Furniture Refinisher	18.75
09090 - Furniture Refinisher Helper	13.77***
09110 - Furniture Repairer, Minor	16.32
09130 - Upholsterer	18.75
11000 - General Services And Support Occupations	
11030 - Cleaner, Vehicles	9.69***
11060 - Elevator Operator	9.69***
11090 - Gardener	14.28***
11122 - Housekeeping Aide	10.13***
11150 - Janitor	10.13***
11210 - Laborer, Grounds Maintenance	10.79***
11240 - Maid or Houseman	9.67***
11260 - Pruner	9.66***
11270 - Tractor Operator	13.07***
11330 - Trail Maintenance Worker	10.79***
11360 - Window Cleaner	11.32***
12000 - Health Occupations	
12010 - Ambulance Driver	18.96
12011 - Breath Alcohol Technician	18.96
12012 - Certified Occupational Therapist Assistant	26.02
12015 - Certified Physical Therapist Assistant	26.02
12020 - Dental Assistant	18.79
12025 - Dental Hygienist	39.73
12030 - EKG Technician	28.73
12035 - Electroneurodiagnostic Technologist	28.73
12040 - Emergency Medical Technician	18.96
12071 - Licensed Practical Nurse I	16.95
12072 - Licensed Practical Nurse II	18.96
12073 - Licensed Practical Nurse III	21.14
12100 - Medical Assistant	13.42***
12130 - Medical Laboratory Technician	18.82
12160 - Medical Record Clerk	14.97***
12190 - Medical Record Technician	17.77
12195 - Medical Transcriptionist	16.95
12210 - Nuclear Medicine Technologist	41.68
12221 - Nursing Assistant I	12.43***
12222 - Nursing Assistant II	13.97***
12223 - Nursing Assistant III	15.24***
12224 - Nursing Assistant IV	17.12
12235 - Optical Dispenser	18.96
12236 - Optical Technician	16.95
12250 - Pharmacy Technician	15.49***
12280 - Phlebotomist	16.95
12305 - Radiologic Technologist	28.73
12311 - Registered Nurse I	23.50
12312 - Registered Nurse II	28.73
12313 - Registered Nurse II, Specialist	28.73
12314 - Registered Nurse III	34.76
12315 - Registered Nurse III, Anesthetist	34.76
12316 - Registered Nurse IV	41.68
12317 - Scheduler (Drug and Alcohol Testing)	23.50

12320 - Substance Abuse Treatment Counselor	23.50
13000 - Information And Arts Occupations	
13011 - Exhibits Specialist I	21.42
13012 - Exhibits Specialist II	26.53
13013 - Exhibits Specialist III	32.45
13041 - Illustrator I	21.42
13042 - Illustrator II	26.53
13043 - Illustrator III	32.45
13047 - Librarian	29.38
13050 - Library Aide/Clerk	17.05
13054 - Library Information Technology Systems Administrator	26.53
13058 - Library Technician	18.11
13061 - Media Specialist I	19.15
13062 - Media Specialist II	21.42
13063 - Media Specialist III	23.87
13071 - Photographer I	19.15
13072 - Photographer II	21.42
13073 - Photographer III	26.53
13074 - Photographer IV	32.45
13075 - Photographer V	39.27
13090 - Technical Order Library Clerk	21.42
13110 - Video Teleconference Technician	19.15
14000 - Information Technology Occupations	
14041 - Computer Operator I	15.71***
14042 - Computer Operator II	17.22
14043 - Computer Operator III	19.19
14044 - Computer Operator IV	21.33
14045 - Computer Operator V	23.62
14071 - Computer Programmer I	(see 1) 15.73***
14072 - Computer Programmer II	(see 1) 19.50
14073 - Computer Programmer III	(see 1) 23.84
14074 - Computer Programmer IV	(see 1)
14101 - Computer Systems Analyst I	(see 1) 24.23
14102 - Computer Systems Analyst II	(see 1)
14103 - Computer Systems Analyst III	(see 1)
14150 - Peripheral Equipment Operator	15.71***
14160 - Personal Computer Support Technician	21.33
14170 - System Support Specialist	21.24
15000 - Instructional Occupations	
15010 - Aircrew Training Devices Instructor (Non-Rated)	24.23
15020 - Aircrew Training Devices Instructor (Rated)	29.32
15030 - Air Crew Training Devices Instructor (Pilot)	34.91
15050 - Computer Based Training Specialist / Instructor	24.23
15060 - Educational Technologist	29.40
15070 - Flight Instructor (Pilot)	34.91
15080 - Graphic Artist	20.47
15085 - Maintenance Test Pilot, Fixed, Jet/Prop	34.91
15086 - Maintenance Test Pilot, Rotary Wing	34.91
15088 - Non-Maintenance Test/Co-Pilot	34.91
15090 - Technical Instructor	17.67
15095 - Technical Instructor/Course Developer	23.78
15110 - Test Proctor	15.70***
15120 - Tutor	15.70***
16000 - Laundry, Dry-Cleaning, Pressing And Related Occupations	
16010 - Assembler	10.83***
16030 - Counter Attendant	10.83***
16040 - Dry Cleaner	12.36***
16070 - Finisher, Flatwork, Machine	10.83***
16090 - Presser, Hand	10.83***
16110 - Presser, Machine, Drycleaning	10.83***
16130 - Presser, Machine, Shirts	10.83***
16160 - Presser, Machine, Wearing Apparel, Laundry	10.83***
16190 - Sewing Machine Operator	12.88***
16220 - Tailor	13.40***
16250 - Washer, Machine	11.34***
19000 - Machine Tool Operation And Repair Occupations	
19010 - Machine-Tool Operator (Tool Room)	19.46
19040 - Tool And Die Maker	24.46
21000 - Materials Handling And Packing Occupations	
21020 - Forklift Operator	15.36***
21030 - Material Coordinator	22.97
21040 - Material Expediter	22.97
21050 - Material Handling Laborer	12.57***
21071 - Order Filler	10.62***
21080 - Production Line Worker (Food Processing)	15.36***
21110 - Shipping Packer	17.12
21130 - Shipping/Receiving Clerk	17.12
21140 - Store Worker I	15.83***
21150 - Stock Clerk	22.26

21210 - Tools And Parts Attendant	15.36***
21410 - Warehouse Specialist	15.36***
23000 - Mechanics And Maintenance And Repair Occupations	
23010 - Aerospace Structural Welder	25.04
23019 - Aircraft Logs and Records Technician	19.47
23021 - Aircraft Mechanic I	23.84
23022 - Aircraft Mechanic II	25.04
23023 - Aircraft Mechanic III	26.30
23040 - Aircraft Mechanic Helper	16.58
23050 - Aircraft, Painter	22.39
23060 - Aircraft Servicer	19.47
23070 - Aircraft Survival Flight Equipment Technician	22.39
23080 - Aircraft Worker	21.03
23091 - Aircrew Life Support Equipment (ALSE) Mechanic I	21.03
23092 - Aircrew Life Support Equipment (ALSE) Mechanic II	23.84
23110 - Appliance Mechanic	19.46
23120 - Bicycle Repairer	15.61***
23125 - Cable Splicer	22.47
23130 - Carpenter, Maintenance	17.58
23140 - Carpet Layer	18.20
23160 - Electrician, Maintenance	19.37
23181 - Electronics Technician Maintenance I	18.20
23182 - Electronics Technician Maintenance II	19.46
23183 - Electronics Technician Maintenance III	20.72
23260 - Fabric Worker	16.94
23290 - Fire Alarm System Mechanic	16.77
23310 - Fire Extinguisher Repairer	15.61***
23311 - Fuel Distribution System Mechanic	20.72
23312 - Fuel Distribution System Operator	15.61***
23370 - General Maintenance Worker	13.24***
23380 - Ground Support Equipment Mechanic	23.84
23381 - Ground Support Equipment Servicer	19.47
23382 - Ground Support Equipment Worker	21.03
23391 - Gunsmith I	15.61***
23392 - Gunsmith II	18.20
23393 - Gunsmith III	20.72
23410 - Heating, Ventilation And Air-Conditioning Mechanic	19.27
23411 - Heating, Ventilation And Air Contidioning Mechanic (Research Facility)	20.50
23430 - Heavy Equipment Mechanic	19.50
23440 - Heavy Equipment Operator	18.10
23460 - Instrument Mechanic	20.72
23465 - Laboratory/Shelter Mechanic	19.46
23470 - Laborer	12.57***
23510 - Locksmith	19.46
23530 - Machinery Maintenance Mechanic	23.13
23550 - Machinist, Maintenance	20.72
23580 - Maintenance Trades Helper	11.77***
23591 - Metrology Technician I	20.72
23592 - Metrology Technician II	22.03
23593 - Metrology Technician III	23.33
23640 - Millwright	20.72
23710 - Office Appliance Repairer	19.46
23760 - Painter, Maintenance	17.04
23790 - Pipefitter, Maintenance	19.96
23810 - Plumber, Maintenance	18.75
23820 - Pneudraulic Systems Mechanic	20.72
23850 - Rigger	20.72
23870 - Scale Mechanic	18.20
23890 - Sheet-Metal Worker, Maintenance	19.55
23910 - Small Engine Mechanic	18.20
23931 - Telecommunications Mechanic I	19.96
23932 - Telecommunications Mechanic II	21.24
23950 - Telephone Lineman	20.62
23960 - Welder, Combination, Maintenance	19.96
23965 - Well Driller	21.13
23970 - Woodcraft Worker	20.71
23980 - Woodworker	15.61***
24000 - Personal Needs Occupations	
24550 - Case Manager	15.01***
24570 - Child Care Attendant	10.09***
24580 - Child Care Center Clerk	13.25***
24610 - Chore Aide	14.06***
24620 - Family Readiness And Support Services Coordinator	15.01***
24630 - Homemaker	16.12***
25000 - Plant And System Operations Occupations	

25010 - Boiler Tender	22.79
25040 - Sewage Plant Operator	22.89
25070 - Stationary Engineer	22.79
25190 - Ventilation Equipment Tender	15.72***
25210 - Water Treatment Plant Operator	22.89
27000 - Protective Service Occupations	
27004 - Alarm Monitor	10.90***
27007 - Baggage Inspector	9.63***
27008 - Corrections Officer	14.59***
27010 - Court Security Officer	14.59***
27030 - Detection Dog Handler	10.90***
27040 - Detention Officer	14.59***
27070 - Firefighter	14.59***
27101 - Guard I	9.63***
27102 - Guard II	10.90***
27131 - Police Officer I	14.59***
27132 - Police Officer II	16.21
28000 - Recreation Occupations	
28041 - Carnival Equipment Operator	13.24***
28042 - Carnival Equipment Repairer	14.46***
28043 - Carnival Worker	9.78***
28210 - Gate Attendant/Gate Tender	13.18***
28310 - Lifeguard	11.01***
28350 - Park Attendant (Aide)	14.74***
28510 - Recreation Aide/Health Facility Attendant	11.84***
28515 - Recreation Specialist	18.26
28630 - Sports Official	11.74***
28690 - Swimming Pool Operator	17.71
29000 - Stevedoring/Longshoremen Occupational Services	
29010 - Blocker And Bracer	26.02
29020 - Hatch Tender	26.02
29030 - Line Handler	26.02
29041 - Stevedore I	24.21
29042 - Stevedore II	27.82
30000 - Technical Occupations	
30010 - Air Traffic Control Specialist, Center (HFO) (see 2)	43.06
30011 - Air Traffic Control Specialist, Station (HFO) (see 2)	29.69
30012 - Air Traffic Control Specialist, Terminal (HFO) (see 2)	32.70
30021 - Archeological Technician I	18.17
30022 - Archeological Technician II	20.33
30023 - Archeological Technician III	25.19
30030 - Cartographic Technician	25.19
30040 - Civil Engineering Technician	25.19
30051 - Cryogenic Technician I	27.89
30052 - Cryogenic Technician II	30.80
30061 - Drafter/CAD Operator I	18.17
30062 - Drafter/CAD Operator II	20.33
30063 - Drafter/CAD Operator III	22.66
30064 - Drafter/CAD Operator IV	27.89
30081 - Engineering Technician I	16.19***
30082 - Engineering Technician II	18.17
30083 - Engineering Technician III	20.33
30084 - Engineering Technician IV	25.19
30085 - Engineering Technician V	30.80
30086 - Engineering Technician VI	37.27
30090 - Environmental Technician	25.19
30095 - Evidence Control Specialist	25.19
30210 - Laboratory Technician	22.66
30221 - Latent Fingerprint Technician I	27.89
30222 - Latent Fingerprint Technician II	30.80
30240 - Mathematical Technician	25.19
30361 - Paralegal/Legal Assistant I	19.54
30362 - Paralegal/Legal Assistant II	24.21
30363 - Paralegal/Legal Assistant III	29.61
30364 - Paralegal/Legal Assistant IV	35.83
30375 - Petroleum Supply Specialist	30.80
30390 - Photo-Optics Technician	24.92
30395 - Radiation Control Technician	30.80
30461 - Technical Writer I	25.19
30462 - Technical Writer II	30.80
30463 - Technical Writer III	37.27
30491 - Unexploded Ordnance (UXO) Technician I	27.37
30492 - Unexploded Ordnance (UXO) Technician II	33.11
30493 - Unexploded Ordnance (UXO) Technician III	39.69
30494 - Unexploded (UXO) Safety Escort	27.37
30495 - Unexploded (UXO) Sweep Personnel	27.37
30501 - Weather Forecaster I	27.89
30502 - Weather Forecaster II	33.93
30620 - Weather Observer, Combined Upper Air Or Surface Programs	(see 2) 22.66

30621 - Weather Observer, Senior	(see 2)	25.19
31000 - Transportation/Mobile Equipment Operation Occupations		
31010 - Airplane Pilot		33.11
31020 - Bus Aide		8.97***
31030 - Bus Driver		11.73***
31043 - Driver Courier		10.26***
31260 - Parking and Lot Attendant		9.91***
31290 - Shuttle Bus Driver		11.65***
31310 - Taxi Driver		11.41***
31361 - Truckdriver, Light		11.21***
31362 - Truckdriver, Medium		12.16***
31363 - Truckdriver, Heavy		16.11***
31364 - Truckdriver, Tractor-Trailer		16.11***
99000 - Miscellaneous Occupations		
99020 - Cabin Safety Specialist		16.14***
99030 - Cashier		10.01***
99050 - Desk Clerk		9.71***
99095 - Embalmer		27.37
99130 - Flight Follower		27.37
99251 - Laboratory Animal Caretaker I		24.31
99252 - Laboratory Animal Caretaker II		26.56
99260 - Marketing Analyst		21.54
99310 - Mortician		27.37
99410 - Pest Controller		16.07***
99510 - Photofinishing Worker		14.38***
99710 - Recycling Laborer		17.32
99711 - Recycling Specialist		23.38
99730 - Refuse Collector		16.40
99810 - Sales Clerk		10.63***
99820 - School Crossing Guard		17.96
99830 - Survey Party Chief		23.99
99831 - Surveying Aide		13.65***
99832 - Surveying Technician		17.73
99840 - Vending Machine Attendant		24.31
99841 - Vending Machine Repairer		30.96
99842 - Vending Machine Repairer Helper		24.31

***Workers in this classification may be entitled to a higher minimum wage under Executive Order 14026 (\$16.20 per hour). Please see the Note at the top of the wage determination for more information. Please also note that the minimum wage requirements of Executive Order 14026 are not currently being enforced as to contracts or contract-like instruments entered into with the federal government in connection with seasonal recreational services or seasonal recreational equipment rental for the general public on federal lands.

ALL OCCUPATIONS LISTED ABOVE RECEIVE THE FOLLOWING BENEFITS:

HEALTH & WELFARE: \$4.98 per hour, up to 40 hours per week, or \$199.20 per week or \$863.20 per month

HEALTH & WELFARE EO 13706: \$4.57 per hour, up to 40 hours per week, or \$182.80 per week, or \$792.13 per month*

*This rate is to be used only when compensating employees for performance on an SCA-covered contract also covered by EO 13706, Establishing Paid Sick Leave for Federal Contractors. A contractor may not receive credit toward its SCA obligations for any paid sick leave provided pursuant to EO 13706.

VACATION: 2 weeks paid vacation after 1 year of service with a contractor or successor; and 4 weeks after 3 years. Length of service includes the whole span of continuous service with the present contractor or successor, wherever employed, and with the predecessor contractors in the performance of similar work at the same Federal facility. (Reg. 29 CFR 4.173)

HOLIDAYS: A minimum of eleven paid holidays per year: New Year's Day, Martin Luther King Jr.'s Birthday, Washington's Birthday, Memorial Day, Juneteenth National Independence Day, Independence Day, Labor Day, Columbus Day, Veterans' Day, Thanksgiving Day, and Christmas Day. (A contractor may substitute for any of the named holidays another day off with pay in accordance with a plan communicated to the employees involved.) (See 29 CFR 4.174)

THE OCCUPATIONS WHICH HAVE NUMBERED FOOTNOTES IN PARENTHESES RECEIVE THE FOLLOWING:

1) COMPUTER EMPLOYEES: This wage determination does not apply to any individual employed in a bona fide executive, administrative, or professional capacity, as defined in 29 C.F.R. Part 541. (See 41 C.F.R. 6701(3)). Because most Computer Systems Analysts and Computer Programmers who are paid at least \$27.63 per hour (or at least \$684 per week if paid on a salary or fee basis) likely qualify as exempt computer professionals under 29 U.S.C. 213(a)(1) and 29 U.S.C. 213(a)(17), this wage determination may not include wage rates for all occupations within those job families. In such instances, a conformance will be necessary if there are nonexempt employees in these job families working on the contract.

Job titles vary widely and change quickly in the computer industry, and are not determinative of whether an employee is an exempt computer professional. To be exempt, computer employees who satisfy the compensation requirements must also have a primary duty that consists of:

(1) The application of systems analysis techniques and procedures, including consulting with users, to determine hardware, software or system functional specifications;

(2) The design, development, documentation, analysis, creation, testing or modification of computer systems or programs, including prototypes, based on and related to user or system design specifications;

(3) The design, documentation, testing, creation or modification of computer programs related to machine operating systems; or

(4) A combination of the aforementioned duties, the performance of which requires the same level of skills. (29 C.F.R. 541.400).

Any computer employee who meets the applicable compensation requirements and the above duties test qualifies as an exempt computer professional under both section 13(a)(1) and section 13(a)(17) of the Fair Labor Standards Act. (Field Assistance Bulletin No. 2006-3 (Dec. 14, 2006)). Accordingly, this wage determination will not apply to any exempt computer employee regardless of which of these two exemptions is utilized.

2) AIR TRAFFIC CONTROLLERS AND WEATHER OBSERVERS - NIGHT PAY & SUNDAY PAY: If you work at night as part of a regular tour of duty, you will earn a night differential and receive an additional 10% of basic pay for any hours worked between 6pm and 6am. If you are a full-time employed (40 hours a week) and Sunday is part of your regularly scheduled workweek, you are paid at your rate of basic pay plus a Sunday premium of 25% of your basic rate for each hour of Sunday work which is not overtime (i.e. occasional work on Sunday outside the normal tour of duty is considered overtime work).

**** HAZARDOUS PAY DIFFERENTIAL ****

An 8 percent differential is applicable to employees employed in a position that represents a high degree of hazard when working with or in close proximity to ordnance, explosives, and incendiary materials. This includes work such as screening, blending, dying, mixing, and pressing of sensitive ordnance, explosives, and pyrotechnic compositions such as lead azide, black powder and photoflash powder. All dry-house activities involving propellants or explosives. Demilitarization, modification, renovation, demolition, and maintenance operations on sensitive ordnance, explosives and incendiary materials. All operations involving re-grading and cleaning of artillery ranges.

A 4 percent differential is applicable to employees employed in a position that represents a low degree of hazard when working with, or in close proximity to ordnance, (or employees possibly adjacent to) explosives and incendiary materials which involves potential injury such as laceration of hands, face, or arms of the employee engaged in the operation, irritation of the skin, minor burns and the like; minimal damage to immediate or adjacent work area or equipment being used. All operations involving, unloading, storage, and hauling of ordnance, explosive, and incendiary ordnance material other than small arms ammunition. These differentials are only applicable to work that has been specifically designated by the agency for ordnance, explosives, and incendiary material differential pay.

**** UNIFORM ALLOWANCE ****

If employees are required to wear uniforms in the performance of this contract (either by the terms of the Government contract, by the employer, by the state or local law, etc.), the cost of furnishing such uniforms and maintaining (by laundering or dry cleaning) such uniforms is an expense that may not be borne by an employee where such cost reduces the hourly rate below that required by the wage determination. The Department of Labor will accept payment in accordance with the following standards as compliance:

The contractor or subcontractor is required to furnish all employees with an adequate number of uniforms without cost or to reimburse employees for the actual cost of the uniforms. In addition, where uniform cleaning and maintenance is made the responsibility of the employee, all contractors and subcontractors subject to this wage determination shall (in the absence of a bona fide collective bargaining agreement providing for a different amount, or the furnishing of contrary affirmative proof as to the actual cost), reimburse all employees for such cleaning and maintenance at a rate of \$3.35 per week (or \$.67 cents per day). However, in those instances where the uniforms furnished are made of "wash and wear" materials, may be routinely washed and dried with other personal garments, and do not require any special treatment such as dry cleaning, daily washing, or commercial laundering in order to meet the cleanliness or appearance standards set by the terms of the Government contract, by the contractor, by law, or by the nature of the work, there is no requirement that employees be reimbursed for uniform maintenance costs.

** SERVICE CONTRACT ACT DIRECTORY OF OCCUPATIONS **

The duties of employees under job titles listed are those described in the "Service Contract Act Directory of Occupations", Fifth Edition (Revision 1), dated September 2015, unless otherwise indicated.

** REQUEST FOR AUTHORIZATION OF ADDITIONAL CLASSIFICATION AND WAGE RATE, Standard Form 1444 (SF-1444) **

Conformance Process:

The contracting officer shall require that any class of service employee which is not listed herein and which is to be employed under the contract (i.e., the work to be performed is not performed by any classification listed in the wage determination), be classified by the contractor so as to provide a reasonable relationship (i.e., appropriate level of skill comparison) between such unlisted classifications and the classifications listed in the wage determination (See 29 CFR 4.6(b)(2)(i)). Such conforming procedures shall be initiated by the contractor prior to the performance of contract work by such unlisted class(es) of employees (See 29 CFR 4.6(b)(2)(ii)). The Wage and Hour Division shall make a final determination of conformed classification, wage rate, and/or fringe benefits which shall be paid to all employees performing in the classification from the first day of work on which contract work is performed by them in the classification. Failure to pay such unlisted employees the compensation agreed upon by the interested parties and/or fully determined by the Wage and Hour Division retroactive to the date such class of employees commenced contract work shall be a violation of the Act and this contract. (See 29 CFR 4.6(b)(2)(v)). When multiple wage determinations are included in a contract, a separate SF-1444 should be prepared for each wage determination to which a class(es) is to be conformed.

The process for preparing a conformance request is as follows:

- 1) When preparing the bid, the contractor identifies the need for a conformed occupation(s) and computes a proposed rate(s).
- 2) After contract award, the contractor prepares a written report listing in order the proposed classification title(s), a Federal grade equivalency (FGE) for each proposed classification(s), job description(s), and rationale for proposed wage rate(s), including information regarding the agreement or disagreement of the authorized representative of the employees involved, or where there is no authorized representative, the employees themselves. This report should be submitted to the contracting officer no later than 30 days after such unlisted class(es) of employees performs any contract work.
- 3) The contracting officer reviews the proposed action and promptly submits a report of the action, together with the agency's recommendations and pertinent information including the position of the contractor and the employees, to the U.S. Department of Labor, Wage and Hour Division, for review (See 29 CFR 4.6(b)(2)(ii)).
- 4) Within 30 days of receipt, the Wage and Hour Division approves, modifies, or disapproves the action via transmittal to the agency contracting officer, or notifies the contracting officer that additional time will be required to process the request.
- 5) The contracting officer transmits the Wage and Hour Division's decision to the contractor.
- 6) Each affected employee shall be furnished by the contractor with a written copy of such determination or it shall be posted as a part of the wage determination (See 29 CFR 4.6(b)(2)(iii)).

Information required by the Regulations must be submitted on SF-1444 or bond paper.

When preparing a conformance request, the "Service Contract Act Directory of Occupations" should be used to compare job definitions to ensure that duties requested are not performed by a classification already listed in the wage determination. Remember, it is not the job title, but the required tasks that determine whether a class is included in an established wage determination. Conformances may not be used to artificially split, combine, or subdivide classifications listed in the wage determination (See 29 CFR 4.152(c)(1))."

CERTIFICATION OF NON-EMPLOYMENT OF CONVICTED SEXUAL OFFENDERS

Pursuant to Guam Public Law 28-24, as amended by Guam Public Law 28-98, if a contract for services is awarded to an Offeror, then the service provider must warrant that no person in its employment who has been convicted of a sex offense under the provisions of Chapter 25 of Title 9 of the Guam Code Annotated or of an offense defined in Article 2 of Chapter 28 of Title 9 of the Guam Code Annotated, or who has been convicted in any other jurisdiction of an offense with the same elements as heretofore defined, or who is listed on the Sex Offender Registry, shall provide services on behalf of the service provider while on government of Guam property, with the exception of public highways. If any employee of a service provider is providing services on government property and is convicted subsequent to an award of a contract, then the service provider warrants that it will notify the GSWA of the conviction within twenty-four hours of the conviction and will immediately remove such convicted person from providing services on government of Guam property. If the service provider is found to be in violation of any of the provisions of this paragraph, then the GSWA will give notice to the service provider to take corrective action. The service provider shall take corrective action within twenty-four hours of notice from the GSWA, and the service provider shall notify the GSWA when action has been taken. If the service provider fails to take corrective steps within twenty-four hours of notice from the GSWA, then the GSWA in its sole discretion may suspend temporarily any contract for services.

I, _____ being a duly authorized representative of the Offeror,
 (print name)

acknowledge the requirements described above, have ensured that the Proposal as submitted addresses these requirements, and certify that if awarded the contract, the Offeror will follow these mandates.

 (Company Name)

 (Title)

 (Signature)

 (Date)



GUAM SOLID WASTE AUTHORITY
546 NORTH MARINE CORPS DRIVE TAMUNING, GUAM 96913
TEL: (671) 646-3111 | FAX: (671) 649-3777
WWW.GUAMSOLIDWASTEAUTHORITY.COM

BID BOND

NO. _____

KNOW ALL MEN BY THESE PRESENTS that _____, as Principal Hereinafter called the Principal, and (Bonding Company), _____

A duly admitted insurer under the laws of the Territory of Guam, Surety, hereinafter called the Surety are held firmly bound unto the Territory of Guam for the sum of _____ Dollars (\$ _____), for Payment of which sum will and truly to be made, the said Principal and the said Surety bind ourselves, our heirs, executors, administrators, successors and assigns, jointly and severally, firmly by these presents.

WHEREAS, the Principal has submitted a bid for (identify project by number and brief description)

NOW, THEREFORE, if the Territory of Guam shall accept the bid of the Principal and the Principal shall enter into a contract with the Territory of Guam in accordance with the terms of such bid, and give such bond or bonds as may be specified in bidding or Contract Documents with good and sufficient surety for the faithful performance of such Contract and for the prompt payment of labor and material furnished in the prosecution thereof, or in the event of the failure of the Principal to enter such Contract and give such bond or bonds, if the Principal shall pay to the Territory of Guam the difference not to exceed the penalty hereof between the amounts specified in said bid and such larger amount for which the Territory of Guam may in good faith contract with another part to perform work covered by said bid or an appropriate liquidated amount as specified in the Invitation for Bids then this obligation shall be null and void, otherwise to remain full force and effect.

Signed and sealed this _____ day of _____ 20_____.

(PRINCIPAL) (SEAL)

(WITNESS)

(TITLE)

(MAJOR OFFICER OF SURETY)

(TITLE)

(MAJOR OFFICER OF SURETY)

(TITLE)

(RESIDENTIAL GENERAL AGENT)

SEE INSTRUCTIONS IN BACK PAGE FOR SUPPORTING DOCUMENTS REQUIRED.

INSTRUCTION TO PROVIDERS:

NOTICE to all Insurance and Bonding Institutions:

The Bond requires the signatures of the Vendor, two (2) major Officers of the Surety and Resident General Agent, if the Surety is a foreigner or alien surety.

When the form is submitted to the Guam Solid Waste Authority, it should be accompanied with copies of the following:

1. Current Certificate of Authority to do business on Guam Issued by the Department of Revenue and Taxation.
2. Power Of Attorney issued by the Surety to the Resident General Agent.
3. Power of Attorney issued by two (2) major officers of the Surety to whoever is signing on their behalf.

Bonds, submitted as Bid Guarantee, without signatures and supporting documents are invalid and Bids will be rejected.

GOVERNMENT OF GUAM

GENERAL TERMS AND CONDITIONS

SEALED BID SOLICITATION AND AWARD

ONLY THOSE BOXES CHECKED BELOW ARE APPLICABLE TO THIS BID

1. **AUTHORITY:**

This solicitation is issued subject to all the provisions of the Guam Procurement Act (5GCA, Chapter 5) and the Guam Procurement Regulations (copies of both are available at the Office of the Complier of laws, Department of Law, copies available for inspection at the Guam Solid Waste Authority). It requires all parties involved in the Preparation, negotiation, performance, or administration of contracts to act in good faith.

2. **GENERAL INTENTION:** Unless otherwise specified, these General Terms and conditions are intended for the bidder to provide the Government of Guam (Government) with specified services or with materials, supplies or equipment completely assembled and ready for use.

3. **TAXES:** Bidders are cautioned that they are subject to Guam Income Taxes as well as all other taxes on Guam transactions. Specific information on taxes may be obtained from the Director of Revenue and Taxation.

4. **LICENSING:** Bidders are cautioned that the Government will not consider for award any offer submitted by a bidder who has not complied with the Guam Licensing law. Specific information on licenses may be obtained from the Director of Revenue and Taxation.

5. **LOCAL PROCUREMENT PREFERENCE:** All procurement of supplies and services where possible, will be made from among businesses licensed to do business on Guam in accordance with section 5008 of the Guam Procurement Act (5GCA, Chapter 5) and Section 1104 of the Guam Procurement Regulations.

6. **COMPLIANCE WITH SPECIFICATIONS AND OTHER SOLICITATION REQUIREMENTS:** Bidders shall comply with all specifications and other requirements of the Solicitation.

7. **“ALL OR NONE” BIDS:** Unless otherwise allowed under this Solicitation, “all or none” bids may be deemed to be non-responsive. If the bid is so limited, the Government may reject part of such proposal and award on the remainder.

NOTE: By checking this item, The Government is requesting all of the bid items to be items to be bided or none at all. **The Government will not award on an itemized basis.** Reference 3-101.06 of the Guam Procurement Regulations.

8. **INDEPENDENT PRICE DETERMINATION:** The bidder, upon signing the Invitation for Bid, certifies that the prices in his bid were derived without collusion, and acknowledges that collusion and anti-competitive practices are prohibited by law. Violations will be subject to the provision of Section 5651 of that of the Guam Procurement Act. Other existing civil, criminal or administrative remedies are not impaired and may be in addition to the remedies in Section 5651 of the Government code. By submitting a bid, the bidder certifies that its price was independently arrived at without collusion.

9. **BIDDER’S PRICE:** The Government will consider not more than two (2) (basic and Alternate) item prices and the bidder shall explain fully each price if supplies, materials, equipment, and/or specified services offered comply with specifications and the products origin. Where basic or alternate bid meets the minimum required specification, cost and other factors will be considered. Failure to explain this requirement will result in rejection of the bid.

10. **BID ENVELOPE:** Envelope shall be sealed and marked with the Bidder’s name, Bid number, time, date and place of Bid opening.

11. **BID GUARANTEE REQUIREMENT:** Bidder is required to submit a Bid Guarantee Bond or standby irrevocable Letter of Credit or Certified Check or Cashier’s Check in the same bid envelope to be held by the Government pending delivery of items being procured. The Bid Guarantee Bond, Letter of Credit, Certified Check or cashier’s check must be issued by any local surety or banking institution licensed to do business on Guam and made payable to the Guam Solid Waste Authority in the amount of fifteen percent (15%) of the total bid offer. The Bid Bond must be submitted on Government Standard Form BB-1 (copy enclosed). Personal Checks will not be accepted as Bid Guarantee. If a successful Bidder (contractor) withdraws from the bid or fails to enter into contract within the prescribed time, such Bid guarantee will be forfeited to the Government of Guam. Bids will be disqualified if not accompanied by Bid Bond, Letter of Credit, Certified Check or Cashier’s Check. Bidder must include in his/her bid, valid copies of a Power of Attorney from the Surety and a Certificate of Authority from the Government of Guam to show proof that the surety company named on the bond instrument is authorized by the Government of Guam to be qualified to do business on Guam. For detailed information on bonding matters, contact the Department of Revenue and Taxation. Failure to submit a valid Power of Attorney and Certificate of Authority on the surety is cause for rejection of bid. (GPR Section 3109(c)(3)) **Pursuant to 5 GCA Section 5212, all competitive sealed bidding for the procurement of supplies or services exceeding \$25,000 must be accompanied by bid security in the amount of 15% of the total bid price.**

12. **PERFORMANCE GUARANTEE:** Bidders, who are awarded a contract under this solicitation, guarantee that goods will be delivered or required services performed within the time specified. Failure to perform the contract in a satisfactory manner may be cause for suspension or debarment from doing business with the Government and for enforcement of Section 23 of these General terms and Conditions. In addition, the Government will hold the Vendor liable and will enforce the requirements as set forth in Section 41 of these General Terms and Conditions.

13. **SURETY BONDS:** Bid and Performance Bonds coverage must be signed or countersigned in Guam by a foreign or alien surety’s resident general agent. The Surety must be an Insurance Company, authorized by the Government of Guam and qualified to do business in Guam. Bids will be disqualified if the Surety Company does not have a valid Certificate of Authority from the Government of Guam to conduct business in Guam.

14. **COMPETENCY OF BIDDERS:** Bids will be considered only from the such bidders who, in the opinion of the Government, can show evidence of their ability, experience, equipment, and facilities to render satisfactory service.

15. **DETERMINATION OF RESPONSIBILITY OF BIDDERS:** The Guam Solid Waste Authority reserves the right for securing from bidders information to determine whether or not they are responsible and to inspect plant site, place of business; and supplies and services as necessary to determine their responsibility in accordance with Section 15 of these General Terms and Conditions (GPR Section 3-401).

16. **STANDARD FOR DETERMINATION OF LOWEST RESPONSIBLE BIDDER:** In determining the lowest responsible offer, the Guam Solid Waste Authority shall be guided by the following:

- a) Price of items offered.
- b) The ability, capacity, and skill of the Bidder to perform.
- c) Whether the bidder can perform promptly within the specified time.
- d) The quality of performance of the Bidder with regards to awards previously made to him.
- e) The previous and existing compliance by the Bidder with laws and regulations relative to procurement.
- f) The sufficiency of the financial resources and ability of the Bidder to perform.
- g) The ability of the bidder to provide future maintenance and services for the subject of the award.
- h) The compliance with all of the conditions to the Solicitation.

17. **TIE BIDS:** If the bids are for the same unit price or total amount in the whole or in part, the Chief Procurement Officer will determine award based on 2 GAR, Div. 4, § 3109(o) (2) or to reject all such bids.

18. **BRAND NAMES:** Any reference in the Solicitation to manufacturer's Brand Names and number is due to lack of a satisfactory specification of commodity description. Such preference is intended to be descriptive, but not restrictive and for the sole purpose of indicating to prospective bidders a description of the article or services that will be satisfactory. Bids on comparable items will be considered provided the bidder clearly states in his bid the exact articles he is offering and how it differs from the original specification.

19. **CONTRACT AWARD:** In accordance with 5 GCA § 5211(g) and 2 GARR § 3109(n), after bids are publicly opened, an award will be made with reasonable promptness by written notice to the lowest responsible and responsive bidder whose bid meets the requirements and criteria set forth in the Invitation for Bids. The award will be made by

- Purchase Order
- Standard Form Contract

20. **DESCRIPTIVE LITERATURE:** Descriptive literature(s) as specified in this solicitation must be furnished as a part of the bid and must be received at the date and time set for the opening Bids. The literature furnished must clearly identify the item(s) in the Bid. The descriptive literature is required to establish for the purpose of evaluation and award details of the product(s) the bidder proposes to furnish including design, materials, components, performance characteristics, methods of manufacture, construction, assembly or other characteristics which are considered appropriate. Rejection of the Bid will be required if the descriptive literature(s) do not show that the product(s) offered conform(s) to the specifications and other requirements of this solicitation. Failure to furnish the descriptive literature(s) by the time specified in the Solicitation will require rejection of the bid.

21. **SAMPLES:** Sample(s) of the item(s) specified in this solicitation must be furnished as a part of the bid and must be received at the date and time set for opening Bids. The sample(s) should represent exactly what the bidder proposes to furnish and will be used to determine if the item(s) offered complies with the specifications. Rejection of the Bid will be required if the sample(s) do not show that the product(s) offered conform(s) to the specifications and other requirements of this solicitation. Failure to furnish the sample(s) by the time specified in the Solicitation will require rejection of the Bid.

22. **LABORATORY TEST:** Successful bidder is required to accompany delivery of his good with a Laboratory Test Report indicating that the product he is furnishing the Government meets with the specifications. This report is on the bidder's account and must be from a certified Testing Association.

23. **AWARD, CANCELLATION, & REJECTION:** Award shall be made to the lowest responsible bidder, whose bid is determined to be the most advantageous to the Government, taking into consideration the evaluation factors set forth in this solicitation. No other factors or criteria shall be used in the evaluation. The right is reserved as the interest of the Government may require to waive any minor irregularity in bid received. The Guam Solid Waste Authority shall have the authority to award, cancel, or reject bids, in whole or in part for any one or more items if he determines it is in the public interest. In case of an error in the extension of prices, unit price will govern. It is the policy of the Government to award contracts to qualified local bidders. The Government reserves the right to increase or decrease the quantity of the items for award and make additional awards for the same type of items and the vendor agrees to such modifications and additional awards based on the bid prices for a period of thirty (30) days after original award. No award shall be made under this solicitation which shall require advance payment or irrevocable letter of credit from the government (GPR Section 3-202.14.1)

24. **MARKING:** Each outside container shall be marked with the Purchase Order number, item number, brief item description and quantity. Letter marking shall not be less than ¾" In height.

25. **SCHEDULE FOR DELIVERY:** Successful bidder shall notify the Guam Solid Waste Authority, Telephone No. 647-4312 at least twenty-four (24) hours before delivery of any item under this solicitation.

26. **BILL OF SALE:** Successful supplier shall render Bills of Sale for each item delivered under this contract. Failure to comply with this requirement will result in rejection of delivery. The Bill of Sale must accompany the items delivered but will not be considered as an invoice for payment. Supplier shall bill the Government in accordance with billing instructions as indicated on the Purchase Order.

27. **MANUFACTURER'S CERTIFICATE:** Successful bidder is required, upon delivery of any item under this solicitation, to furnish a certificate from the manufacturer indicating that the goods meet the specifications. Failure to comply with this request will result in rejection of delivery or payment. Supplier shall bill the Government in accordance with billing instructions as indicated on the Purchase Order.

28. **INSPECTION:** All supplies, materials, equipment, or services delivered under this contract shall be subject to the inspection and/or test conducted by the Government at destination. If in any case the supplies, materials, equipment, or services are found to be

defective in material, workmanship, performance, or otherwise do not conform with the specifications, the Government shall have the right to reject the items or require that they be corrected. The number of days required for correction will be determined by the Government.

29. **MOTOR VEHICLE SAFETY REQUIREMENTS:** The Government will only consider Bids on motor vehicles which comply with the requirements of the National Traffic and Motor Vehicle safety Act of 1966 (Public Law 89-563) and Clean Air Act as amended (Public Law 88-206), that are applicable to Guam. Bidders shall state if the equipment offered comply with these aforementioned Federal Laws.

30. **SAFETY INSPECTIONS:** All motor vehicles delivered under this contract must pass the Government of Guam Vehicle Inspection before delivery at destination.

31. **GUARANTEE:**

a) **Guarantee of Vehicle Type of Equipment**

The successful bidder shall guarantee vehicular type of equipment offered against defective parts, workmanship, and performance, for a period of not less than one (1) year after date of receipt of equipment. Bidder shall also provide service to the equipment for at least one (1) year. Service to be provided shall include, but will not be limited to tune ups (change of spark plugs, contact points and condensers) and lubrication (change of engine and transmission oil). All parts and labor shall be at the expense of the bidder. All parts found defective and not caused by misuse, negligence or accident within the guarantee period shall be repaired, replaced, or adjusted within six (6) working days after notice from the Government and without cost to the Government. Vehicular type of equipment as used in this context shall include equipment used for transportation as differentiated from tractors, backhoes, etc.

b) **Guarantee of Other Type of Equipment:**

The successful bidder shall guarantee all other types of equipment offered, except those mentioned in 31a, above, against defective parts, workmanship, and performance for a period of not less than three (3) months after date of receipt of equipment. Bidder shall also provide service to the equipment for at least three (3) months. All parts found within that period shall be repaired or replaced by the Contractor without cost to the Government. Repairs, adjustments or replacements of defective parts shall be completed by the contractor within six (6) working days after notice from the Government.

(c) **Compliance with this Section is a condition of this Bid.**

32. **REPRESENTATION REGARDING ETHICS IN PUBLIC PROCUREMENT:** The bidder or contractor represents that it has not knowingly influenced and promises that will not knowingly influence a Government employee to breach any of the ethical standards and represents that it has not violated, is not violating, and promises that it will not violate the prohibition against gratuities and kickbacks set forth on Chapter 11 (Ethics in Public Contracting) of the Guam Procurement Act and in Chapter 11 of the Guam Procurement Regulations.

33. **REPRESENTATION REGARDING CONTINGENT FEES:** The contractor represents that it has not retained a person to solicit or secure a Government contract upon and agreement or understanding for a commission, percentage, brokerage, or contingent fee, except for retention of bona fide employees of bona fide established commercial selling agencies for the purpose of securing business (GPR Section 11-207).

34. **EQUAL EMPLOYMENT OPPORTUNITY:** Contractors shall not discriminate against any employee or applicant of employment because of race, color, religion, sex, or national origin. The contractor will take affirmative action to ensure that employees are treated equally during employment without regards to their race, color, religion, sex, or national origin.

35. **COMPLIANCE WITH LAWS:** Bidders awarded a contract under this Solicitation shall comply with the applicable standard, provisions, and stipulations of all pertinent Federal and/or local laws, rules, and regulations relative to the performance of this contract and the furnishing of goods.

36. **CHANGE ORDER:** Any order issued relative to awards made under this solicitation will be subject to and in accordance with the provisions of Section 6-101-03.1 of the Guam Procurement Regulations.

37. **STOP WORK ORDER:** Any stop work order issued relative to awards made under this solicitation will be subject to and in accordance with the provisions of Section 6-101-04.1 of the Guam Procurement Regulations.

38. **CANCELLATION OF INVITATION FOR BIDS OR REQUEST FOR PROPOSALS:** Any Invitation for Bid may be cancelled, or any or all bids or proposals may be rejected in whole or in part as may be specified in the solicitation, when it is in the best interests of the Territory in accordance with regulations promulgated by the Policy Office. The reasons therefor shall be made part of the contract file.

39. **TIME FOR COMPLETION:** It is hereby understood and mutually agreed by and between the contractor and the Government that the time for delivery to final destination or the timely performance of certain services is an essential condition of this contract. If the contractor refuses or fails to perform any of the provisions of this contract within the time specified in the Purchase Order (from the date Purchase Order is acknowledged by the vendor), then the contractor is in default. Defaults will be treated subject to and in accordance with the provisions of Section 6-101-08 of the Guam Procurement Regulations.

40. **JUSTIFICATION OF DELAY:** Bidders who are awarded contracts under this Solicitation, guarantee that the goods will be delivered to their destination or required services rendered within the time specified. If the bidder is not able to meet the specified delivery date, he is required to notify the Guam Solid Waste Authority of such delay. Notification shall be in writing and shall be received by the Guam Solid Waste Authority at least twenty-four (24) hours before the specified delivery date. Notification of delay shall include an explanation of the causes and reasons for the delay including statement(s) from supplier or shipping company causing the delay. The Government reserves the right to reject delay justification if, in the opinion of the Chief Procurement Officer, such justification is not adequate.

41. **SERVICE-DISABLED VETERAN OWNED BUSINESS PREFERENCE:** Bidding is subject to the policy in favor of Service-Disabled Veteran Owned Business as defined in 5 GCA sections 5011 and 5012.

42. **LIQUIDATED DAMAGES:** When the contractor is given notice of delay or nonperformance as specified in Paragraph 1 (Default) of the Termination for Default Clause of this contract and fails to cure in the time specified, the contractor shall be liable for

damages for delay in the amount of one-fourth of one percent (1%) of outstanding order per calendar day from date set for cure until either the territory reasonable obtains similar supplies or services if the contractor is terminated for default, or until the contractor provides the supplies or services if the contractor is not terminated for default. To the extent that the contractor's delay or non-performance is excused under Paragraph 15 (Excuse for Nonperformance or Delayed Performance) of the Termination for Default Clause of this contract, liquidated damages shall not be due the territory. The contractor remains liable for damages caused other than by delay. 2 GAR, Div. 4 §6101(d).

[x] 43. **PHYSICAL LIABILITY:** If it becomes necessary for the Vendor, either as principal, agent or employee, to enter upon the premises or property of the Government of Guam in order to construct, erect, inspect, make delivery or remove property hereunder, the Vendor hereby covenants and agrees to take, use, provide and make all proper, necessary and sufficient precautions, safeguards and protections against occurrence of any accidents, injuries or damages to any person or property during the progress of the work herein covered, and to be responsible for, and to indemnify and save harmless the Government of Guam from the payment of all sums of money by reason of all or any such accidents, injuries, or damages that may occur upon or about such work, and fines, penalties and loss incurred for or by reasons of the violations of any territorial ordinance, regulations, or the laws of Guam or the United States, while the work is in progress. Contractor will carry insurance to indemnify the Government of Guam against any claim for loss, damage or injury to property or persons arising out of the performance of the Contractor or its employees and agents of the services covered by the contract and the use, misuse or failure of any equipment used by the contractor or his employees or agents, and shall provide certificates of such insurance to the Government of Guam when required.

[x] 44. Contract will be cancelled if funds not appropriated or insufficient, and that government will timely inform contractor. 2 GAR, Div.4 §3121(e) (1) (C) and 2 GAR, Div. 4 §3121 (e)(1)(D).

[x] 45. **CONTACT FOR CONTRACT ADMINISTRATION:** If your firm receives a contract as a result of this Solicitation, Please designate a person whom we may contact for prompt administration.

Name: _____

Title: _____

Address: _____

Telephone: _____

SEALED BID SOLICITATION INSTRUCTIONS

1. **BID FORMS:** Each bidder shall be provided with two (2) sets of Solicitation forms. Additional copies may be provided upon request. Bidders requesting additional copies of said forms will be charged per page in accordance with Section 6114 of the Government Code of Guam. All payments for this purpose shall be by cash, certified check or money order and shall be made payable to the Guam Solid Waste Authority.
2. **PREPARATIONS OF BIDS:**
 - a. Bidders are required to examine the drawings, specifications, schedule, and all instructions. Failure to do so will be at bidder's risk.
 - b. Each bidder shall furnish the information required by the Solicitation. The bidder shall sign the solicitation and print or type his name on the Schedule. Erasures or other changes must be initialed by the person signing the bid. Bids signed by an agent are to be accompanied by evidence of this authority unless such evidence has been previously furnished to the issuing office.
 - c. Unit price for each unit offered shall be shown and such price shall include packing unless otherwise specified. A total shall be entered in the amount column of the Schedule for each item offered. In case of discrepancies between a unit price and extended price, the unit price will be presumed to be correct.
 - d. Bids for supplies or services other than those specified will not be considered. Time, if stated as a number of days, means calendar days and will include Saturdays, Sundays, and holidays beginning the day after the issuance of a Notice to Proceed. Time stated ending on Saturday, Sunday or Government of Guam legal holiday will end at the close of the next business day.
 - e. No Entitlement to Preparation Costs – the bidder expressly waives any right it may have against the government for any expenses incurred in connection with the preparation of its bid.
3. **EXPLANATION TO BIDDERS:** Any explanation desired by a bidder regarding the meaning or interpretation of the Solicitation, drawings, specifications, etc., must be submitted in writing and with sufficient time allowed for a written reply to reach all bidders before the submission of their bids. Oral explanations or instructions given before the award of the contract will not be binding. Any information given to a prospective bidder concerning a Solicitation will be furnished to all prospective bidders in writing as an amendment to the Solicitation if such information would be prejudicial to uninformed bidders.
4. **ACKNOWLEDGEMENT OF AMENDMENTS TO SOLICITATIONS:** Receipt of an amendment to a Solicitation by a bidder must be acknowledged by signing an acknowledgement of receipt of the amendment. Such acknowledgement must be received prior to the hour and date specified for receipt of bids.
5. **SUBMISSION OF BIDS:**
 - a. Bids and modifications thereof shall be enclosed in sealed envelopes and addressed to the office specified in the Solicitation. The bidder shall show the hour and date specified in the Solicitation for receipt, the Solicitation number, and the name and address of the bidder on the face of the envelope.
 - b. Electronic bids will not be considered unless authorized by the Solicitation. However, bids may be modified or withdrawn by written or electronic notice, provided such notice is received prior to the hour and date specified for receipt (see paragraph 6 of these instructions).
 - c. Samples of items, when required, must be submitted within the time specified, unless otherwise specified by the Government, at no expense to the Government. If not destroyed by testing, samples will be returned at bidder's request and expense, unless otherwise specified by the Solicitation.
 - d. Samples or descriptive literature should not be submitted unless it is required by this solicitation. Regardless of any attempt by a bidder to condition the bid, unsolicited samples or descriptive literature will not be examined or tested at the bidder's risk, and will not be deemed to vary any of the provisions of this Solicitation.
6. **FAILURE TO SUBMIT BID:** If no bid is to be submitted, do not return the solicitation documents unless otherwise specified. A letter or postcard shall be sent to the issuing office advising whether future Solicitations for the type of supplies or services covered by this Solicitation are desired.
7. **LATE BID, LATE WITHDRAWALS, AND LATE MODIFICATIONS:**
 - a. Definition: Any bid received after the time and date set for receipt of bids is late. Any withdrawal or modification of a bid received after the time and date set for opening of bids at the place designated for opening is late (Guam Procurement Regulations Section 3-202)
 - b. Treatment: No late bid, late modification, or late withdrawal will be considered unless received before contract award, and the bid, modification, or withdrawal would have been timely but for the action or inaction of territorial personnel directly serving the procurement activity.
9. **GOVERNMENT FURNISHED PROPERTY:** No material, labor or facilities will be furnished by the Government unless otherwise provided for in the Solicitation.
10. **CANCELLATION OR REVISION OF BID:** This IFB may be canceled, or any and all bids may be rejected in whole or in part as may be pursuant to GAR § 3115, when it is in the best interest of the Government. Additionally, in accordance with GAR § 9105, if prior to award it is determined that a solicitation or proposed award of a contract is in violation of the law, then the solicitation or proposed award shall be canceled or revised to comply with the law. The reasons therefore shall be made part of the contract file.
11. **REJECTION OF BIDS:** Any bidder submitted in response to this IFB may be rejected in whole or in part with it is in the best interest of the Government, in accordance with GAR § 3115(e). Reasons for rejecting bids include but are not limited to: (1) The business that submitted the bid is non-responsive as determined under GAR § 3116; (2) The bid ultimately fails to meet the announced requirements of the Government in some material respect; or (3) The bid price is clearly unreasonable. Upon request, successful bidders shall be advised of the reasons for rejection.

When bids are rejected, or a solicitation canceled after bids are received, the bids which have been opened shall be retained in the procurement file, or if unopened, returned to the bidders upon request, or otherwise disposed of pursuant to GAR § 3115(g).

- 12. TERMINATION OF CONTRACT: 1. TERMINATION OF CONVENIENCE PURSUANT TO GAR § 6101(10)**
- (a) **Termination:** The Government, when the interest of the Government so requires, may terminate this contract in whole or in part, for the Convenience of the Government. The Purchasing Agency shall give written notice of the termination to the contractor specifying the part of the contract terminated when termination becomes effective.
 - (b) **Contractor's Obligations:** The contractor shall incur no further obligations in connection with the terminated work and on the date set in the notice of termination the contractor will stop work to the extent specified.
 - (c) **Condition of Termination:** Notwithstanding the foregoing, the cessation of services for people requiring services shall be contingent upon the Government obtaining a substitute provider for the services and the contractor shall cooperate by taking all reasonable and necessary steps to ensure that services are not interrupted and transferred to the succeeding provider. The contractor shall issue a written memorandum detailing the status of the contractor's ongoing services initiating termination or any fault of either party.
- 13. SELLER'S INVOICES:** Invoices shall be prepared and submitted in quadruplicate (one copy shall be marked "original") unless otherwise specified. Invoices shall be "certified true and correct" and shall contain the following information: Contract and order number (if any), item numbers, description of supplies or services, sizes, quantities, unit prices, and extended total. Bill of lading number and weight of shipment will be shown for shipments made on Government bills of lading.
- 14. RECEIPT, OPENING AND RECORDING OF BIDS:** Bids and modifications shall be publicly opened in the presence of one or more witnesses, at the time, date, and place designated in the Invitation for Bids. The name of each bidder, the bid price, and such other information as is deemed appropriate by the Procurement Officer, shall be read aloud and recorded, or otherwise made available. The names and addresses of required witnesses shall be recorded at the opening. The opened bids shall be available for public inspection except to the extent the bidder designates trade secrets or other proprietary data to be confidential as set forth in accordance with Section 12, below. Material so designated shall accompany the bid and shall be readily separable from the bid in order to facilitate public inspection of the non-confidential portion of the bid. Prices, makes and models or catalogue numbers of the items offered, deliveries, and terms of payment shall be publicly available at the time of bid opening regardless of any designation to the contrary (Guam Procurement Regulations Section 3-202.12.2).
- 15. CONFIDENTIAL DATA:** The Procurement Officer shall examine the bids to determine the validity of any requests for nondisclosure of trade secrets and other proprietary data.
- 16. PROHIBITION AGAINST GRATUITIES AND KICKBACKS:** With respect to this procurement and any other contract that bidder may have or wish to enter into with the Government, the bidder represents that he/she has not violated, is not violating, and promises that he will not violate the prohibition against gratuities and kickbacks set forth in the Guam Procurement Regulations – GAR § 11170(e)
- 17. STATEMENT OF QUALIFICATIONS** The ability capacity and skill of the Bidders to perform; Whether the bidder can perform promptly or within the specified time; The quality of performance of the Bidder with regards to awards previously made to him; The sufficiency of the financial resources and ability of the bidders to perform; And the compliance with all of the conditions to the solicitation.
- 18. WAGE AND BENEFIT COMPLIANCE-CONTRACTORS PROVIDING SERVICES:**
- (a) Contractor with regard to all person its employs whose purpose in whole or in part is the direct delivery of services contracted for with the Government of Guam in this procurement, shall pay such employees in accordance with the Wage Determination for Guam and the Northern Marianas Islands issued and promulgated by the U.S. Department of Labor for such labor as is employed in the direct deliverance of deliverables to the government of Guam. 5 GCA § 5801 Contractor shall be responsible for flowing down this obligation to its subcontractors.
 - (b) The Wage Determination most recently issued by the U.S. Department of Labor at the time this Agreement was awarded to Contractor shall be used to determine wages and benefits which shall be paid to employees pursuant to this clause. 5 GCA § 5801
 - (c) Should any contract contain a renewal clause, then at the time of renewal adjustments there shall be stipulations contained in that contract for applying the Wage Determination, so that the Wage Determination promulgated by the U.S. Department of Labor on a date most recent to the renewal date shall apply. 5 GCA § 5801
 - (d) In addition to the Wage Determination detailed above, health and similar benefits for employees having a minimum value as detailed in the wage Determination issued and promulgated by the U.S. Department of labor shall apply. Contractor shall pay a minimum of ten (10) paid holidays per annum per employee. 5 GCA § 5802
 - (e) Any violation of Contractor or its subcontractors obligations of this section shall be investigated by the Guam Department of Labor and may include a monetary penalty assessment by the Guam Department of Labor of no less that One Hundred Dollars (\$100.00) per day, and no more than One Thousand Dollars (\$1,000.00) per day, until such time as a violation has been corrected, as well as the payment of all black wages and benefits due. 5 GCA § 5803
 - (f) In addition to any and all other breach of contract actions the Government of Guam may have under this procurement, in the event there is a violation in the process set forth in subsection (e) above, Contractor may be placed on probationary status by the Chief Procurement Officer of the General Service Agency, or its successor, for a period of one (1) year.
During the probationary status, a Contractor shall not be awarded any contract by any instrumentality of the Government of Guam. A Contractor who has been on probationary status, or has been assessed a monetary

penalty pursuant to 5 GCA Article 13 Title 5 may appeal such penalty of probationary status to the Superior Court of Guam. 5 GCA § 5804

- (g) Contractor along with all proposed offerors and submitter under this procurement were required to submit a Declaration of Compliance with Wage Determination laws as part of this procurement with a copy of the most recent Wage Determination for Guam and the Northern Marianas Islands issued and promulgated by the U.S. Department of Labor. 5 GCA § 5805
- (h) The applicable USDOL Wage Determination Rate Revision (as defined by subsections (b) and (c) is to this Agreement. Contractor agrees to provide upon written request by the Government of Guam written certification of its compliance with its obligations as part of each invoice, along with the names of any employees, their positions, and detailed wage and benefits paid in keeping with this section. Additionally upon request by Government of Guam the Contractor shall submit source documents as to those individuals provide direct services in part or whole under this Agreement and its payments to them of such wages and benefits.

19. **ETHICAL STANDARDS:** With respect to this procurement and any other contract that the Contractor may have, or wish to enter into, with any Government of Guam agency, the Contractor represents that it has not knowingly influenced, and promises that it will not knowingly influence, any government employee to breach any of the ethical standards set forth in the Guam Procurement Law and in any of the Guam Procurement Regulations. – GAR § 11103 (b).
20. **PROHIBITION AGAINST CONTINGENT FEES:** The Contractor represents that he has not retained any person or agency upon an Agreement or Understanding for a percentage, commission, brokerage, or other contingent arrangement, except for retention of bona fide employees or bona fide established commercial selling agencies, to solicit or secure this Agreement or any contract with the government of Guam or its agencies. GAR § 11108(f)
21. **CONTRACTOR'S WARRANTY AS TO EMPLOYEES AND SEX OFFENSES. Reference 5 GCA 5253(b):** : Contractor warrants that no person providing services on behalf of the Contractor has been convicted of a sex offense under the provisions of Chapter 25 of Title 9 of GCA or an offense as defined in Article 2 of Chapter 28, Title 9 GCA, or an offense in another jurisdiction with, at a minimum, the same elements as such offenses, or who is listed on the Sex Offender Registry.
- Contractor warrants that if any person providing services on behalf of Contractor is convicted of a sex offense under the provisions of Chapter 25 of Title 9 GCA, or an offense as defined in Article 2 of Chapter 28, Title 9 GCA, or an offense in another jurisdiction with, at a minimum, the same elements as such offenses, or who is listed on the Sex Offender Registry, that such person will be immediately removed from working at said agency and that the administrator of said agency be informed of such within twenty-four (24) hours of such conviction. Any contractor found in violation of this section, after notice from the Government of Guam, after notice from the contracting authority of such violation, shall within twenty-four (24) hours, take corrective action and shall report such action to the contracting authority. Failure to take corrective action with the stipulated period may result in the temporary suspension of the contract at the discretion of the Government of Guam.
22. **POLICY IN FAVOR OF SERVICE-DISABLED VETERAN OWNED BUSINESSES:** P.L. 31-115 (September 20, 2011) 5 GCA § 5011 and § 5012 In the procurement of any supply or service, (except for professional services), if such supply or service is offered by a Service Disabled Veteran Owned Business "SDVOB", as defined in 5 GCA § 5012, that is at least fifty one percent (51%) owned by service-disabled veteran(s), and if the supply or service is available within the period that is required for the procurement, and the price for the supply or service does not exceed one hundred five percent (105%) of the lowest bidder price, a preference shall be given to that SDVOB by the Government of Guam, and the supply or service shall be purchased from said SDVOB. This shall be in addition to any other procurement benefit the SDVOB may qualify for under Guam law. A business concern is a qualified SDVOB if: (a) the business concern is licensed to do business on 7Guam; (b) the business concern maintains its headquarters on Guam; (c) the business concern is at least fifty-one (51%) owned by a service-disabled veteran(s) who served in the active U.S. military service, was discharged or released under honorable conditions and whose disability is service-connected as demonstrated by a DD214, and certified by an award letter from the U.S. Department of Veterans Affairs; the DD214 and Disability award letter from U.S. Department of Veterans Affairs are submitted to the Government of Guam procuring agency for every service offered; and the service disabled veteran(s) owner(s) of the business concern has filed individual tax returns on Guam for a period of at least three (3) consecutive years.
23. **CERTIFICATION OF INDEPENDENT PRICE DETERMINATION:** The undersigned Bidder certifies that the bid price submitted was Independently arrived at without collusion — GAR § 3126
24. **LICENSING OR CERTIFICATE(S) OF EXEMPTIONS:** Bidders are cautioned that the Government will not consider for award any offer submitted by a bidder who cannot comply with the Guam Licensing Law. Specific information on license or exemptions may be obtained from the Director of Revenue and Taxation.
25. **EQUAL EMPLOYMENT OPPORTUNITY:** Bidder shall not discriminate against any employee or applicant for employment because of race, color, religion, sex, or national origin. The contractor will take affirmative action to ensure that employees are treated equally during employment without regards to their race, color, religion, sex, or national origin.
26. **DISCLOSURES OF MAJOR SHAREHOLDERS:** (5 GCA § 5233) As a condition of submitted a bid, any partnership, sole proprietorship or corporation doing business with the Government of Guam shall submit an affidavit executed under oath that lists the name and address of any person who has held more than ten percent (10%) of the outstanding interest or shares in said month period immediately preceding submission of proposal.



GUAM SOLID WASTE AUTHORITY

LOURDES A. LEON GUERRERO
Governor of Guam

JOSHUA F. TENORIO
Lt. Governor of Guam

IRVIN L. SLIKE
General Manager



IFB TIMETABLE:

The following IFB timetable should be used as a working guide for planning purposes. GSWA reserves the right to adjust this timetable as required during the course of the IFB process.

Registration Form for GSWA IFB Packet will be available on the Guam Solid Waste Authority website at www.gswa.guam.gov .	Friday, November 3, 2023
---	--------------------------

Deadline for Receipt of Written Questions must be e-mailed to the Guam Solid Waste Authority at procurement@gswa.guam.gov , ATTN: General Manager	Thursday, November 9, 2023 on or before 5:00PM Chamorro Standard Time
--	---

Deadline for Answers to Written Questions will be e-mailed to Offerors who registered.	Wednesday, November 14, 2023 on or before 5:00PM Chamorro Standard Time
--	---

Bid Due Date & Bid Opening at the Guam Solid Waste Authority: Administration Office, GSWA Bldg., 2 nd Floor, 546 N. Marine Corps Dr., Tamuning, Guam	Monday, November 20, 2023 at 1:00PM Chamorro Standard Time
---	--



GUAM SOLID WASTE AUTHORITY



LOURDES A. LEON GUERRERO
Governor of Guam

JOSHUA F. TENORIO
Lt. Governor of Guam

IRVIN L. SLIKE
General Manager

ITEM NO.	DESCRIPTION	QTY	UOM	UNIT PRICE	PRICE EXTENSION
1.0	Compact Wheel Loader w/ Attachments	1	EA	\$ _____	\$ _____

SPECIFICATIONS:

Indicate on each line of the technical specifications whether or not each item complies with the specification or an exception is being taken. If additional space is required to fully explain bid exceptions, attach additional typed page(s) to the bid submittal indicating the section number and subsection that has the exception, and provide explanation.

COMPLY / NON-COMPLIANCE

Engine:

Gross HP at 2400 RPM: 73 HP minimum

Peak Torque at 1560 RPM: 206 foot lbs. minimum

Emissions: Compliant with EPA Final Tier 4/EU Stage V

Four cylinders

Powertrain:

Hydrostatic with infinitely variable speed control over full range of operating speeds. 2 speed ranges, joystick mounted F-N-R, acceleration pedal.

Axles: Fixed, 100% differential, manually engaged front axle, fixed conventional differential rear axle

Max rise and fall single wheel: 15 inches maximum, 14 inch minimum

Hydraulically activated, self-adjusting internal wet disc brakes and driveline drum brake

Cooling:

Hydraulically driven, proportionally controlled fan

Articulation Angle: 30 degrees each direction

Cylinders: Heat treated chrome plated polished cylinder rods, hardened steel, replaceable bushings and pivot pins

Hydraulics:

Main pump (loader and steering): 18 GPM standard, 29 GPM with high flow option.

Quick Coupling: Conforms with ISO 16028 quick coupling for all attachments

Electrical:

Voltage: 12-volt

One (1) battery

Battery capacity: 925 CCA

Cab:

Seat: Air ride high back with head rest and dual lumbar support

Noise: Operator ear 70 dBA, Bystander 101 dBA



GUAM SOLID WASTE AUTHORITY

LOURDES A. LEON GUERRERO
Governor of Guam

JOSHUA F. TENORIO
Lt. Governor of Guam

IRVIN L. SLIKE
General Manager



COMPLY / NON-COMPLIANCE

Air conditioning

Steering: Dual tilt and telescoping steering column

Performance: Conforms with SAE J1040, SAE J231, ISO 3471 and ISO 3449 ROPS/FOPS

Operating Weight:

ISO quick coupler and 1CY general purpose bucket / bolt on edge 12,250 lbs. minimum

1.4 CY bucket: 12,800 lbs. maximum

Wheelbase: 7 feet minimum

Dump clearance: 40-degree full height – 8 feet 3 inches

Reach: 40-degree full height – 32 inches

Fork height fully raised: 10 feet minimum

Fork tipping load straight: 7000 lb. maximum

Attachments:

ISO quick coupling mechanism: Conforms with ISO 16028

One (1) 1.4 CY bucket with bold on edge

One (1) Tink claw bucket model 720 or equal

One (1) 60-inch pick-up broom: 800 lb. minimum; 900 lb. max

One (1) Fork: 48 inches minimum

Equipment Warranty:

The Bidder guarantees to the Purchaser that the equipment, upon delivery, will be brand new and will have been constructed using entirely new components. Furthermore, the Bidder assures that any new equipment provided shall be free from any defects in manufacturing workmanship and materials for a duration of 24 months or 2,000 hours, whichever occurs first, commencing from the date of equipment delivery. This warranty encompasses any necessary repairs or replacements without any additional cost to the Purchaser.

Miscellaneous Items:

One (1) operator’s manual hardcopy

One (1) operator’s manual on CD

One (1) complete illustrated parts book

One (1) shop repair manual

One (1) warranty manual

Manufacturer’s training of GSWA crew (8 hours) & contracted mechanics (20 hours)

Online manual for parts, service & repair



GUAM SOLID WASTE AUTHORITY



LOURDES A. LEON GUERRERO
Governor of Guam

JOSHUA F. TENORIO
Lt. Governor of Guam

IRVIN L. SLIKE
General Manager

Delivered with a full tank of fuel

Note: The GSA Federal Contract will be considered along with its terms and conditions if offered.

Bidding On:

Manufacturer: _____

Year: _____

Model: _____

Place of Origin: _____

Date of Delivery: _____

PROCUREMENT PACKAGE DISTRIBUTION LOG

Procurement Packet: Far East Equipment Company LLC GSWA-004-24

1 message

GSWA Procurement <procurement@gswa.guam.gov>

3 November 2023 at 15:28

To: submissions@guamwebz.com

A Procurement Packet has been requested from the website. Below is the copy of the email sent to the user who made the request.

Hafa Adai John Limtiaco,

You requested a Procurement Packet from the website.

Click the link(s) listed below to Download and View the Procurement Packet file(s) for:

> **Download Link: [IFB NO. GSWA-004-24](#)**

Procurement Number: GSWA-004-24

Title/Description: COMPACT WHEEL LOADER

REQUESTED BY:**First Name:** John**Last Name:** Limtiaco**Company:** Far East Equipment Company LLC**Address:** 17-3311 Corsair Rd.**Email:** jlimtiaco@fareastequipment.com**Telephone:** 6718886270**Fax Number:**

<https://guamsolidwasteauthority.com>

Procurement Packet: USA CONTRACTORS, INC. GSWA-004-24

1 message

GSWA Procurement <procurement@gswa.guam.gov>

3 November 2023 at 17:09

To: submissions@guamwebz.com

A Procurement Packet has been requested from the website. Below is the copy of the email sent to the user who made the request.

Hafa Adai Eddie Onopey,

You requested a Procurement Packet from the website.

Click the link(s) listed below to Download and View the Procurement Packet file(s) for:

> **Download Link: [IFB NO. GSWA-004-24](#)**

Procurement Number: GSWA-004-24

Title/Description: COMPACT WHEEL LOADER

REQUESTED BY:**First Name:** Eddie**Last Name:** Onopey**Company:** USA CONTRACTORS, INC.**Address:** 138 Kayen Chando Street**Email:** sales@usacontractorscorp.com**Telephone:** 6716323044**Fax Number:** 6716329000

<https://guamsolidwasteauthority.com>



Procurement Packet: Hawthorne Pacific Corp GSWA-004-24

1 message

GSWA Procurement <procurement@gswa.guam.gov>
To: submissions@guamwebz.com

6 November 2023 at 07:25

A Procurement Packet has been requested from the website. Below is the copy of the email sent to the user who made the request.

Hafa Adal Jimmy Cruz,

You requested a Procurement Packet from the website.

Click the link(s) listed below to Download and View the Procurement Packet file(s) for:
> [Download Link: IFB NO. GSWA-004-24](#)

Procurement Number: GSWA-004-24
Title/Description: COMPACT WHEEL LOADER

REQUESTED BY:

First Name: Jimmy

Last Name: Cruz

Company: Hawthorne Pacific Corp

Address: 196 East Harmon Industrial Park Road Tamuning Guam 96913

Email: jpcruz@hawthornecat.com

Telephone: 671-488-2821

Fax Number:



<https://guamsolidwasteauthority.com>

AMENDMENTS

GUAM SOLID WASTE AUTHORITY



LOURDES A. LEON GUERRERO
Governor of Guam

JOSHUA F. TENORIO
Lt. Governor of Guam

IRVIN L. SLIKE
General Manager



November 14, 2023

INVITATION FOR BID GSWA-004-24 COMPACT WHEEL LOADER W/ ATTACHMENTS

AMENDMENT NO. 1

1. Amend page 31 of 34

From:

Deadline for Receipt of Written Questions must be e-mailed to the Guam Solid Waste Authority at procurement@gswa.guam.gov , ATTN: General Manager	Thursday, November 9, 2023 on or before 5:00PM Chamorro Standard Time
--	---

To Now Read:

Deadline for Receipt of Written Questions must be e-mailed to the Guam Solid Waste Authority at , ATTN: General Manager	Wednesday, November 15, 2023 on or before 5:00PM Chamorro Standard Time
---	---

2. Amend page 31 of 34

From:

Bid Due Date & Bid Opening at the Guam Solid Waste Authority: Administration Office, GSWA Bldg., 2 nd Fl. 546 N. Marine Corps Dr., Tamuning, Guam	Monday, November 20, 2023 at 1:00PM Chamorro Standard Time
--	--

To Now Read:

Bid Due Date & Bid Opening at the Guam Solid Waste Authority: Administration Office, GSWA Bldg., 2 nd Fl. 546 N. Marine Corps Dr., Tamuning, Guam	Wednesday, November 22, 2023 at 1:00PM Chamorro Standard Time
--	---

*All others remain the same.

Irvin L. Slike,
General Manager

ACKNOWLEDGEMENT RECEIPT
Return to GSWA by email or fax
Date: _____ Title: _____ (Contract Number): _____
Fax to: 671-649-3777 Email: procurement@gswa.guam.gov



GSWA PROCUREMENT RECORD Page 48
GUAM SOLID WASTE AUTHORITY



LOURDES A. LEON GUERRERO
 Governor of Guam

JOSHUA F. TENORIO
 Lt. Governor of Guam

IRVIN L. SLIKE
 General Manager

November 20, 2023

INVITATION FOR BID
GSWA-004-24
COMPACT WHEEL LOADER W/ ATTACHMENTS

AMENDMENT NO. 2

1. Amend page 31 of 34

From:

Deadline for Receipt of Written Questions must be e-mailed to the Guam Solid Waste Authority at procurement@gswa.guam.gov , ATTN: General Manager	Wednesday, November 15, 2023 on or before 5:00PM Chamorro Standard Time
--	---

To Now Read:

Deadline for Receipt of Written Questions must be e-mailed to the Guam Solid Waste Authority at procurement@gswa.guam.gov , ATTN: General Manager	Tuesday, November 21, 2023 on or before 5:00PM Chamorro Standard Time
--	---

2. Amend page 31 of 34

From:

Bid Due Date & Bid Opening at the Guam Solid Waste Authority: Administration Office, GSWA Bldg., 2 nd Fl. 546 N. Marine Corps Dr., Tamuning, Guam	Wednesday, November 22, 2023 at 1:00PM Chamorro Standard Time
--	---

To Now Read:

Bid Due Date & Bid Opening at the Guam Solid Waste Authority: Administration Office, GSWA Bldg., 2 nd Fl. 546 N. Marine Corps Dr., Tamuning, Guam	Tuesday, November 28, 2023 at 1:00PM Chamorro Standard Time
--	---

3. Amend to replace pages 32 of 34 through 34 of 34 with the "Revised 11/20/2023 Page 32" through "Revised 11/20/2023 Page 34" attached.

*All others remain the same.

Irvin L. Slike,
 General Manager

ACKNOWLEDGEMENT RECEIPT
 Return to GSWA by email or fax.

Received By: _____

Date: _____

Company Name: _____

Fax to 671-649-3777
 Email: procurement@gswa.guam.gov



GUAM SOLID WASTE AUTHORITY

LOURDES A. LEON GUERRERO
Governor of Guam

JOSHUA F. TENORIO
Lieutenant Governor of Guam

IRVIN L. SLIKE
General Manager



COMPLY / NON-COMPLIANCE

Air conditioning

Steering: Dual tilt and telescoping steering column

Performance: Conforms with SAE J1040, SAE J231, ISO 3471 and ISO 3449 ROPS/FOPS

Operating Weight:

ISO quick coupler and 1CY general purpose bucket / bolt on edge 12,250 lbs. minimum

1.4 CY multi-purpose bucket: 12,800 lbs. maximum

Wheelbase: 7 feet minimum

Dump clearance: 40-degree full height – 8 feet 3 inches

Reach: 40-degree full height – 32 inches

Fork height fully raised: 10 feet minimum

Fork tipping load straight: 7000 lb. maximum

Attachments:

ISO quick coupling mechanism: Conforms with ISO 16028

One (1) additional 1.4 CY bucket with bolt on edge

One (1) Tink claw bucket model 520 or equal

One (1) 60-inch pick-up broom: 800 lb. minimum; 900 lb. max

One (1) Fork: 48 inches minimum

Equipment Warranty:

The Bidder guarantees to the Purchaser that the equipment, upon delivery, will be brand new and will have been constructed using entirely new components. Furthermore, the Bidder assures that any new equipment provided shall be free from any defects in manufacturing workmanship and materials for a duration of 24 months or 2,000 hours, whichever occurs first, commencing from the date of equipment delivery. This warranty encompasses any necessary repairs or replacements without any additional cost to the Purchaser.

Miscellaneous Items:

One (1) operator's manual hardcopy



GUAM SOLID WASTE AUTHORITY

LOURDES A. LEON GUERRERO
Governor of Guam

JOSHUA E. TENORIO
Lieutenant Governor

IRVIN L. SLIKE
General Manager



Delivered with a full tank of fuel _____

Note: The GSA Federal Contract will be considered along with its terms and conditions if offered.

Bidding On:

Manufacturer: _____

Year: _____

Model: _____

Place of Origin: _____

Date of Delivery: _____

GUAM SOLID WASTE AUTHORITY



LOURDES A. LEON GUERRERO
Governor of Guam

JOSHUA F. TENORIO
Lt. Governor of Guam

IRVIN L. SLIKE
General Manager



November 27, 2023

INVITATION FOR BID GSWA-004-24 COMPACT WHEEL LOADER W/ ATTACHMENTS

AMENDMENT NO. 3

1. Amend page 31 of 34

From:

Bid Due Date & Bid Opening at the Guam Solid Waste Authority: Administration Office, GSWA Bldg., 2 nd Fl. 546 N. Marine Corps Dr., Tamuning, Guam	Tuesday, November 28, 2023 at 1:00PM Chamorro Standard Time
--	---

To Now Read:

Bid Due Date & Bid Opening at the Guam Solid Waste Authority: Administration Office, GSWA Bldg., 2 nd Fl. 546 N. Marine Corps Dr., Tamuning, Guam	Tuesday, December 5, 2023 at 1:00PM Chamorro Standard Time
--	--

*All others remain the same.

Irvin L. Slike,
General Manager

ACKNOWLEDGEMENT RECEIPT
Return to GSWA by email or fax

Receipt # _____

Date: _____

Company Name: _____

Fax to: 671-649-3777
Email: procurement@gswa.guam.gov

AMENDMENT DISTRIBUTION LOG



GUAM SOLID WASTE AUTHORITY

LOURDES A. LEON G. JERRERO

OSHUA P. YENDREU

IRVIN SLIKE



November 14, 2023

INVITATION FOR BID GSWA-004-24 COMPACT WHEEL LOADER W/ ATTACHMENTS AMENDMENT NO. 1

1. Amend page 31 of 34
From:

Deadline for Receipt of Written Questions
must be e-mailed to the Guam Solid Waste Authority at
procurement@gswa.guam.gov, ATTN: General
Manager

Thursday, November 9, 2023
on or before 5:00PM
Chamorro Standard Time

To Now Read:

Deadline for Receipt of Written Questions
must be e-mailed to the Guam Solid Waste Authority at
ATTN: General
Manager

Wednesday, November 15, 2023
on or before 5:00PM
Chamorro Standard Time

2. Amend page 31 of 34
From:

Bid Due Date & Bid Opening at the Guam Solid Waste
Authority: Administration Office, GSWA Bldg., 2nd Fl.
546 N. Marine Corps Dr., Tamuning, Guam

Monday, November 20, 2023
at 1:00PM
Chamorro Standard Time

To Now Read:

Bid Due Date & Bid Opening at the Guam Solid Waste
Authority: Administration Office, GSWA Bldg., 2nd Fl.
546 N. Marine Corps Dr., Tamuning, Guam

Wednesday, November 22, 2023
at 1:00PM
Chamorro Standard Time

*All others remain the same.

Irvin L. Slike,
General Manager

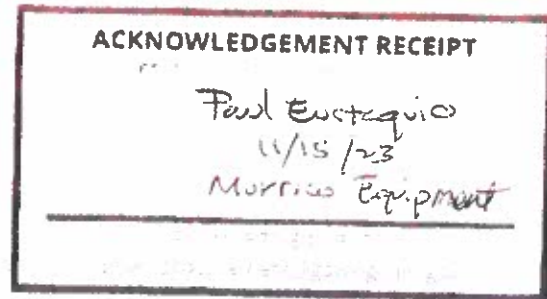



GUAM SOLID WASTE AUTHORITY



November 14, 2023

INVITATION FOR BID GSWA-004-24 COMPACT WHEEL LOADER W/ ATTACHMENTS AMENDMENT NO. 1

1. Amend page 31 of 34

From:

Deadline for Receipt of Written Questions must be e-mailed to the Guam Solid Waste Authority at procurement@gswa.guam.gov, ATTN: General Manager

Thursday, November 9, 2023
on or before 5:00PM
Chamorro Standard Time

To Now Read:

Deadline for Receipt of Written Questions must be e-mailed to the Guam Solid Waste Authority at procurement@gswa.guam.gov, ATTN: General Manager

Wednesday, November 10, 2023
on or before 5:00PM
Chamorro Standard Time

2. Amend page 31 of 34

From:

Bid Due Date & Bid Opening at the Guam Solid Waste Authority: Administration Office, GSWA Bldg., 2nd Fl. 546 N. Marine Corps Dr., Tamuning, Guam

Monday, November 20, 2023
at 1:00PM
Chamorro Standard Time

To Now Read:

Bid Due Date & Bid Opening at the Guam Solid Waste Authority: Administration Office, GSWA Bldg., 2nd Fl. 546 N. Marine Corps Dr., Tamuning, Guam

Wednesday, November 22, 2023
at 1:00PM
Chamorro Standard Time

*All others remain the same.

Irvin L. Slike,
General Manager

ACKNOWLEDGEMENT RECEIPT
Ryne-Paul Santos
11/14/23
Far East Equipment Co. LLC
<small>Procurement@gswa.guam.gov</small>



GUAM SOLID WASTE AUTHORITY

LOURDES A. LEON GUERRERO

JOSHUA F. TENORIO

IRVIN L. SLIKE



November 14, 2023

INVITATION FOR BID GSWA-004-24 COMPACT WHEEL LOADER W/ ATTACHMENTS

AMENDMENT NO. 1

I. Amend page 31 of 34

From:

Deadline for Receipt of Written Questions must be e-mailed to the Guam Solid Waste Authority at procurement@gswa.guam.gov, ATTN: General Manager

Thursday, November 9, 2023
on or before 5:00PM
Chamorro Standard Time

To Now Read:

Deadline for Receipt of Written Questions must be e-mailed to the Guam Solid Waste Authority at procurement@gswa.guam.gov, ATTN: General Manager

Wednesday, November 15, 2023
on or before 5:00PM
Chamorro Standard Time

II. Amend page 31 of 34

From:

Bid Due Date & Bid Opening at the Guam Solid Waste Authority: Administration Office, GSWA Bldg., 2nd Fl. 546 N. Marine Corps Dr., Tamuning, Guam

Monday, November 20, 2023
at 1:00PM
Chamorro Standard Time

To Now Read:

Bid Due Date & Bid Opening at the Guam Solid Waste Authority: Administration Office, GSWA Bldg., 2nd Fl. 546 N. Marine Corps Dr., Tamuning, Guam

Wednesday, November 22, 2023
at 1:00PM
Chamorro Standard Time

*All others remain the same.

Irvin L. Slike,
General Manager

ACKNOWLEDGEMENT RECEIPT	
Return to GSWA by email or fax	
Received by:	Eddie Onopey
Date:	11-16-2023
Organization:	USA CONTRACTORS, INC
Fax to: 671-649-3777	
Email: procurement@gswa.guam.gov	

GUAM SOLID WASTE AUTHORITY

LOURDES A. LEON GUERRERO

JOSHUA F. TENORTO

IRVIN L. SLIKE

November 20, 2023

**INVITATION FOR BID
GSWA-004-24
COMPACT WHEEL LOADER W/ ATTACHMENTS**

AMENDMENT NO. 2

1. Amend page 31 of 34

From:

Deadline for Receipt of Written Questions
must be e-mailed to the Guam Solid Waste Authority at
procurement@gswa.guam.gov ATTN: General Manager

Wednesday, November 15, 2023
on or before 5:00PM
Chamorro Standard Time

To Now Read:

Deadline for Receipt of Written Questions
must be e-mailed to the Guam Solid Waste Authority at
procurement@gswa.guam.gov, ATTN: General Manager

Tuesday, November 21, 2023
on or before 5:00PM
Chamorro Standard Time

2. Amend page 31 of 34

From:

Bid Due Date & Bid Opening at the Guam Solid Waste
Authority: Administration Office, GSWA Bldg., 2nd Fl.
546 N. Marine Corps Dr., Tamuning, Guam

Wednesday, November 22, 2023
at 1:00PM
Chamorro Standard Time

To Now Read:

Bid Due Date & Bid Opening at the Guam Solid Waste
Authority: Administration Office, GSWA Bldg., 2nd Fl.
546 N. Marine Corps Dr., Tamuning, Guam

Tuesday, November 28, 2023
at 1:00PM
Chamorro Standard Time

3. Amend to replace pages 32 of 34 through 34 of 34 with the "Revised 11/20/2023 Page 32" through "Revised 11/20/2023 Page 34" attached.

*All others remain the same.



Irvin L. Slike,
General Manager

ACKNOWLEDGEMENT RECEIPT	
Return to GSWA by email or fax	
Rece. by	Paul Eustaquio
Date	11/22/23
Company Name	Morrice Equipment
Fax to: 671 649 3777	
Email: procurement@gswa.guam.gov	



GUAM SOLID WASTE AUTHORITY

LOURDES A. LEON GUERRERO

JOSHUA F. TENORIO

IRVIN L. SLIKE



November 20, 2023

**INVITATION FOR BID
GSWA-004-24
COMPACT WHEEL LOADER W/ ATTACHMENTS
AMENDMENT NO. 2**

1. Amend page 31 of 34

From:

Deadline for Receipt of Written Questions
must be e-mailed to the Guam Solid Waste Authority at
procurement@gswa.guam.gov, ATTN: General Manager

Wednesday, November 15, 2023
on or before 5:00PM
Chamorro Standard Time

To Now Read:

Deadline for Receipt of Written Questions
must be e-mailed to the Guam Solid Waste Authority at
procurement@gswa.guam.gov, ATTN: General Manager

Tuesday, November 21, 2023
on or before 5:00PM
Chamorro Standard Time

2. Amend page 31 of 34

From:

Bid Due Date & Bid Opening at the Guam Solid Waste
Authority: Administration Office, GSWA Bldg, 2nd Fl.
546 N. Marine Corps Dr., Tamuning, Guam

Wednesday, November 22, 2023
at 1:00PM
Chamorro Standard Time

To Now Read:

Bid Due Date & Bid Opening at the Guam Solid Waste
Authority: Administration Office, GSWA Bldg, 2nd Fl.
546 N. Marine Corps Dr., Tamuning, Guam

Tuesday, November 28, 2023
at 1:00PM
Chamorro Standard Time

3. Amend to replace pages 32 of 34 through 34 of 34 with the "Revised 11/20/2023 Page 32" through "Revised 11/20/2023 Page 34" attached.

*All others remain the same.

Irvin L. Slike,
General Manager

ACKNOWLEDGEMENT RECEIPT	
Return to GSWA by email or fax.	
Name	Ryne Paul Santos
Date	11/22/23
Company Name	Far East Equipment Co LLC
Fax to: 671 649 3777	
Email: procurement@gswa.guam.gov	



GUAM SOLID WASTE AUTHORITY

LOURDES A. LEON GUERRERO
Secretary of Finance

JOSHUA T. BENORIO
Assistant Secretary

IRVIN L. SEIKE
General Manager



ITEM NO.	DESCRIPTION	QTY	UOM	UNIT PRICE	PRICE EXTENSION
1.0	Compact Wheel Loader w/ Attachments	1	EA	\$ _____	\$ _____

SPECIFICATIONS:

Indicate on each line of the technical specifications whether or not each item complies with the specification or an exception is being taken. If additional space is required to fully explain bid exceptions, attach additional typed page(s) to the bid submittal indicating the section number and subsection that has the exception, and provide explanation.

COMPLY / NON-COMPLIANCE

Engine:

Gross HP at 2400 RPM: 73 HP minimum

Peak Torque at 1560 RPM: 206 foot lbs. minimum

Emissions: Compliant with EPA Final Tier 4/ EU Stage V

Four cylinders

Powertrain:

Hydrostatic with infinitely variable speed control over full range of operating speeds. 2 speed ranges, joystick mounted F-N-R, acceleration pedal.

Axes: Fixed, 100% differential, manually engaged front axle, fixed conventional differential rear axle or oscillating rear axle

Max rise and fall single wheel: 15 inches maximum, 14 inch minimum

Hydraulically activated, self-adjusting internal wet disc brakes and driveline drum brake

Cooling:

Hydraulically driven, proportionally controlled fan or belt-driven fan

Articulation Angle: 30 degrees each direction

Cylinders: Heat treated chrome plated polished cylinder rods, hardened steel, replaceable bushings and pivot pins

Hydraulics:

Main pump (loader and steering): 18 GPM standard, 29 GPM with high flow option.

Quick Coupling: Conforms with ISO 16028 quick coupling for all attachments



GUAM SOLID WASTE AUTHORITY

LOURDES A. LEON GUERRERO
Governor of Guam

JOSHUA F. TENORIO
Lieutenant Governor of Guam

IRVIN L. SLIKE
General Manager



COMPLY / NON-COMPLIANCE

Air conditioning

Steering: Dual tilt and telescoping steering column

Performance: Conforms with SAE J1040, SAE J231, ISO 3471 and ISO 3449 ROPS/FOPS

Operating Weight:

ISO quick coupler and 1CY general purpose bucket / bolt on edge 12,250 lbs. minimum

1.4 CY multi-purpose bucket: 12,800 lbs. maximum

Wheelbase: 7 feet minimum

Dump clearance: 40-degree full height - 8 feet 3 inches

Reach: 40-degree full height - 32 inches

Fork height fully raised: 10 feet minimum

Fork tipping load straight: 7000 lb. maximum

Attachments:

ISO quick coupling mechanism: Conforms with ISO 16028

One (1) additional 1.4 CY bucket with bolt on edge

One (1) Tink claw bucket model 520 or equal

One (1) 60-inch pick-up broom: 800 lb. minimum; 900 lb. max

One (1) Fork: 48 inches minimum

Equipment Warranty:

The Bidder guarantees to the Purchaser that the equipment, upon delivery, will be brand new and will have been constructed using entirely new components. Furthermore, the Bidder assures that any new equipment provided shall be free from any defects in manufacturing workmanship and materials for a duration of 24 months or 2,000 hours, whichever occurs first, commencing from the date of equipment delivery. This warranty encompasses any necessary repairs or replacements without any additional cost to the Purchaser.

Miscellaneous Items:

One (1) operator's manual hardcopy



GUAM SOLID WASTE AUTHORITY

LOURDES A. LYON GUERRERO
Chairperson

JOSUIUS F. TEAGRIO

IRVIN L. SLIKE
General Manager



Delivered with a full tank of fuel _____

Note: The GSA Federal Contract will be considered along with its terms and conditions if offered.

Bidding On:

Manufacturer: _____

Year: _____

Model: _____

Place of Origin: _____

Date of Delivery: _____

Transmission Report

Date/Time 11-22-2023 01:14:18 p.m. Transmit Header Text
 Local ID 1 6714734370 Local Name 1 PUI

This document : Confirmed
 (reduced sample and details below)
 Document size : 8.5"x11"



GUAM SOLID WASTE AUTHORITY



LOURDES A. LEON GUERINERO JOSHUA P. TENDRILIO IRVIN L. SLIKE
Commissioner of GSWA 11 Governor of Guam General Manager

November 20, 2023

**INVITATION FOR BID
 GSWA-004-24**

COMPACT WHEEL LOADER W/ ATTACHMENTS

AMENDMENT NO. 2

1. Amend page 31 of 34

From:
 Deadline for Receipt of Written Questions Wednesday, November 15, 2023
 must be e-mailed to the Guam Solid Waste Authority at on or before 5:00PM
procurement@gswa.guam.gov. ATTN: General Manager Chamorro Standard Time

To Now Read:
 Deadline for Receipt of Written Questions Tuesday, November 21, 2023
 must be e-mailed to the Guam Solid Waste Authority at on or before 5:00PM
procurement@gswa.guam.gov. ATTN: General Manager Chamorro Standard Time

2. Amend page 31 of 34

From:
 Bid Due Date & Bid Opening at the Guam Solid Waste Wednesday, November 22, 2023
 Authority: Administration Office, GSWA Bldg, 2nd Fl. at 1:00PM
 546 N. Marine Corps Dr., Tamuning, Guam Chamorro Standard Time

To Now Read:
 Bid Due Date & Bid Opening at the Guam Solid Waste Tuesday, November 28, 2023
 Authority: Administration Office, GSWA Bldg, 2nd Fl. at 1:00PM
 546 N. Marine Corps Dr., Tamuning, Guam Chamorro Standard Time

3. Amend to replace pages 32 of 34 through 34 of 34 with the "Revised 11/20/2023 Page 32" through "Revised 11/20/2023 Page 34" attached.

*All others remain the same.

Irvin L. Slike
 Irvin L. Slike,
 General Manager

ACKNOWLEDGEMENT RECEIPT	
<small>Return to GSWA by email or fax.</small>	
Received by: <i>Ryne Paul Santos</i>	
Date: <i>11/20/23</i>	
Company Name: <i>Paul Equipment Co. LLC</i>	
<small>Fax to: 671 649 3777</small>	
<small>Email: procurement@gswa.guam.gov</small>	

546 N. MARINE CORPS DRIVE, TAMUNING, GU 96913 * TEL: 671-646-3111 | FAX: 671-649-3777
<https://www.guamsolidwasteauthority.com/>

Total Pages Scanned : 4

Total Pages Confirmed : 4

No.	Job	Remote Station	Start Time	Duration	Pages	Line	Mode	Job Type	Results
001	306	6716493777	01:12:52 p.m. 11-22-2023	00:00:49	4/4	1	EC	HS	CP28800

Abbreviations:

- | | | | | |
|------------------|-------------------|-------------------|------------------------|--------------------------|
| HS: Host send | PL: Polled local | MP: Mailbox print | CP: Completed | TS: Terminated by system |
| HR: Host receive | PR: Polled remote | RP: Report | FA: Fall | G3: Group 3 |
| WS: Waiting send | MS: Mailbox save | FF: Fax Forward | TU: Terminated by user | EC: Error Correct |



GUAM SOLID WASTE AUTHORITY

LOURDES A. LEON GUERRERO
Governor of Guam

JOSHUA F. FENORIO
Governor of Guam

IRVIN L. SLIKE
General Manager



ITEM NO.	DESCRIPTION	QTY	UOM	UNIT PRICE	PRICE EXTENSION
1.0	Compact Wheel Loader w/ Attachments	1	EA	\$ _____	\$ _____

SPECIFICATIONS:

Indicate on each line of the technical specifications whether or not each item complies with the specification or an exception is being taken. If additional space is required to fully explain bid exceptions, attach additional typed page(s) to the bid submittal indicating the section number and subsection that has the exception, and provide explanation.

COMPLY / NON-COMPLIANCE

Engine:

Gross HP at 2400 RPM: 73 HP minimum

Peak Torque at 1560 RPM: 206 foot lbs. minimum

Emissions: Compliant with EPA Final Tier 4/EU Stage V

Four cylinders

Powertrain:

Hydrostatic with infinitely variable speed control over full range of operating speeds. 2 speed ranges, joystick mounted F-N-R, acceleration pedal.

Axes: Fixed, 100% differential, manually engaged front axle, fixed conventional differential rear axle or oscillating rear axle

Max rise and fall single wheel: 15 inches maximum, 14 inch minimum

Hydraulically activated, self-adjusting internal wet disc brakes and driveline drum brake

Cooling:

Hydraulically driven, proportionally controlled fan or belt-driven fan

Articulation Angle: 30 degrees each direction

Cylinders: Heat treated chrome plated polished cylinder rods, hardened steel, replaceable bushings and pivot pins

Hydraulics:

Main pump (loader and steering): 18 GPM standard, 29 GPM with high flow option

Quick Coupling: Conforms with ISO 16028 quick coupling for all attachments

Electrical:

Voltage: 12-volt or 24-volt electrical system

Battery: One (1) 24-volt or two (2) 12-volt

Battery capacity: One (1) 925 CCA or Two (2) 900 CCA

Cab:

Seat: Air ride high back with head rest and dual lumbar support or mechanical suspension seat

Noise: Operator ear 70 dBA, Bystander 101 dBA



GUAM SOLID WASTE AUTHORITY

LOURDES A. LEON GUERRERO
Governor of Guam

JOSHUA F. TENORIO
Deputy Governor

IRVIN L. SLIKE
General Manager



COMPLY / NON-COMPLIANCE

Air conditioning

Steering: Dual tilt and telescoping steering column

Performance: Conforms with SAE J1040, SAE J231, ISO 3471 and ISO 3449 ROPS/FOPS

Operating Weight:

ISO quick coupler and 1CY general purpose bucket / bolt on edge 12,250 lbs. minimum

1.4 CY multi-purpose bucket: 12,800 lbs. maximum

Wheelbase: 7 feet minimum

Dump clearance: 40-degree full height – 8 feet 3 inches

Reach: 40-degree full height – 32 inches

Fork height fully raised: 10 feet minimum

Fork tipping load straight 7000 lb. maximum

Attachments:

ISO quick coupling mechanism: Conforms with ISO 16025

One (1) additional 1.4 CY bucket with bolt on edge

One (1) Tink claw bucket model 520 or equal

One (1) 60-inch pick-up broom: 800 lb. minimum, 900 lb. max

One (1) Fork: 48 inches minimum

Equipment Warranty:

The Bidder guarantees to the Purchaser that the equipment, upon delivery, will be brand new and will have been constructed using entirely new components. Furthermore, the Bidder assures that any new equipment provided shall be free from any defects in manufacturing workmanship and materials for a duration of 24 months or 2,000 hours, whichever occurs first, commencing from the date of equipment delivery. This warranty encompasses any necessary repairs or replacements without any additional cost to the Purchaser.

Miscellaneous Items:

One (1) operator's manual hardcopy

One (1) operator's manual on CD

One (1) complete illustrated parts book

One (1) shop repair manual

One (1) warranty manual

Manufacturer's training of GSWA crew (8 hours) & contracted mechanics (20 hours)

Online manual for parts, service & repair



GUAM SOLID WASTE AUTHORITY

LOURDES A. LEON GUERRERO
Governor of Guam

JOSHUA F. TENORIO
Deputy Governor

IRVIN L. SLIKE
General Manager



Delivered with a full tank of fuel

Note: The GSA Federal Contract will be considered along with its terms and conditions if offered.

Bidding On:

Manufacturer: _____

Year: _____

Model: _____

Place of Origin: _____

Date of Delivery: _____



GUAM SOLID WASTE AUTHORITY



LOURDES A. LEON GUERRERO

JOSHUA F. TENORIO

IRVIN L. SLIKE

November 20, 2023

**INVITATION FOR BID
GSWA-004-24
COMPACT WHEEL LOADER W/ ATTACHMENTS
AMENDMENT NO. 2**

1. Amend page 31 of 34

From:

Deadline for Receipt of Written Questions
must be e-mailed to the Guam Solid Waste Authority at
procurement@gswa.guam.gov, ATTN: General Manager

Wednesday, November 15, 2023
on or before 5:00PM
Chamorro Standard Time

To Now Read:

Deadline for Receipt of Written Questions
must be e-mailed to the Guam Solid Waste Authority at
procurement@gswa.guam.gov, ATTN: General Manager

Tuesday, November 21, 2023
on or before 5:00PM
Chamorro Standard Time

2. Amend page 31 of 34

From:

Bid Due Date & Bid Opening at the Guam Solid Waste
Authority: Administration Office, GSWA Bldg, 2nd Fl.
546 N. Marine Corps Dr., Tamuning, Guam

Wednesday, November 22, 2023
at 1:00PM
Chamorro Standard Time

To Now Read:

Bid Due Date & Bid Opening at the Guam Solid Waste
Authority: Administration Office, GSWA Bldg, 2nd Fl.
546 N. Marine Corps Dr., Tamuning, Guam

Tuesday, November 28, 2023
at 1:00PM
Chamorro Standard Time

3. Amend to replace pages 32 of 34 through 34 of 34 with the "Revised 11/20/2023 Page 32" through "Revised 11/20/2023 Page 34" attached.

*All others remain the same.

Irvin L. Slike,
General Manager

ACKNOWLEDGEMENT RECEIPT

Return to GSWA by email or fax

Name: Eddie Onopey
Date: November 21, 2023
Company Name: USA CONTRACTORS, INC.

Fax to 671 649 3777

Email: procurement@gswa.guam.gov



GUAM SOLID WASTE AUTHORITY



LOURDES A. LEON GUERRERO
Governor of Guam

JOSHUA F. TENORIO
1st Governor of Guam

IRVIN L. SLIKE
General Manager

November 27, 2023

**INVITATION FOR BID
GSWA-004-24
COMPACT WHEEL LOADER W/ ATTACHMENTS
AMENDMENT NO. 3**

1. Amend page 31 of 34

From:

Bid Due Date & Bid Opening at the Guam Solid Waste Authority: Administration Office, GSWA Bldg., 2 nd Fl. 546 N. Marine Corps Dr., Tamuning, Guam	Tuesday, November 28, 2023 at 1:00PM Chamorro Standard Time
--	---

To Now Read:

Bid Due Date & Bid Opening at the Guam Solid Waste Authority: Administration Office, GSWA Bldg., 2 nd Fl. 546 N. Marine Corps Dr., Tamuning, Guam	Tuesday, December 5, 2023 at 1:00PM Chamorro Standard Time
--	--

*All others remain the same.

Irvin L. Slike,
General Manager

ACKNOWLEDGEMENT RECEIPT	
Return to GSWA by email or fax	
Received By	<i>Paul Eustaquio</i>
Date:	<i>11/27/23</i>
Company Name	<i>Marrico Equipment</i>
Fax to: 671-649-3777	
Email: procurement@gswa.guam.gov	

GUAM SOLID WASTE AUTHORITY



LOURDES A. LEON GUERRERO
Secretary of Guam

JOSHUA F. TENORIO
Secretary of Guam

IRVIN L. SLIKE
General Manager



November 27, 2023

**INVITATION FOR BID
GSWA-004-24
COMPACT WHEEL LOADER W/ ATTACHMENTS**

AMENDMENT NO. 3

1. Amend page 31 of 34

From:

Bid Due Date & Bid Opening at the Guam Solid Waste
Authority: Administration Office, GSWA Bldg., 2nd Fl.
546 N. Marine Corps Dr., Tamuning, Guam

Tuesday, November 28, 2023
at 1:00PM
Chamorro Standard Time

To Now Read:

Bid Due Date & Bid Opening at the Guam Solid Waste
Authority: Administration Office, GSWA Bldg., 2nd Fl.
546 N. Marine Corps Dr., Tamuning, Guam

Tuesday, December 5, 2023
at 1:00PM
Chamorro Standard Time

*All others remain the same.

Irvin L. Slike,
General Manager

ACKNOWLEDGEMENT RECEIPT	
Return to GSWA by email or fax.	
Received By:	<i>Ryne-Paul Santos</i>
Date:	<i>11/20/23</i>
Company Name:	<i>Far East Equipment Co. LLC</i>
Fax to: 671-649-3777	
Email: procurement@gswa.guam.gov	



GUAM SOLID WASTE AUTHORITY



LOURDES A. LEON GUERRERO
Governor of Guam

JOSHUA F. TENORIO
Lt. Governor of Guam

IRVIN L. SLIKE
General Manager

November 27, 2023

INVITATION FOR BID GSWA-004-24 COMPACT WHEEL LOADER W/ ATTACHMENTS

AMENDMENT NO. 3

1. Amend page 31 of 34

From:

Bid Due Date & Bid Opening at the Guam Solid Waste Authority: Administration Office, GSWA Bldg., 2nd Fl. 546 N. Marine Corps Dr., Tamuning, Guam

Tuesday, November 28, 2023
at 1:00PM
Chamorro Standard Time

To Now Read:

Bid Due Date & Bid Opening at the Guam Solid Waste Authority: Administration Office, GSWA Bldg., 2nd Fl. 546 N. Marine Corps Dr., Tamuning, Guam

Tuesday, December 5, 2023
at 1:00PM
Chamorro Standard Time

*All others remain the same.

Irvin L. Slike,
General Manager

ACKNOWLEDGEMENT RECEIPT	
Return to GSWA by email or fax.	
Received By:	<u>Eddie Onopey</u>
Date:	<u>11-28-2023</u>
Company Name:	<u>USA CONTRACTORS, INC.</u>
Fax to: 671 649 3777	
Email: procurement@gswa.guam.gov	

**GSWA-004-24: Compact Wheel Loader w/ Attachments**

1 message

GSWA Procurement <procurement@gswa.guam.gov>

27 November 2023 at 14:28

To: Jimmy Cruz <JPCRUZ@hawthornecat.com>

Cc: Alicia Fejeran <alicia.fejeran@gswa.guam.gov>, Keilani Mesa <keilani.mesa@gswa.guam.gov>, Irvin Slike <irvin.slike@gswa.guam.gov>

Håfa Adai!

Please see attached Amendment No. 3 for your reference. Please sign the acknowledgement portion on the bottom of the page & submit back at your earliest convenience.

Thank you!

*Si Yu'os Ma'åse,***Camaryn Aguon****Buyer I****GUAM SOLID WASTE AUTHORITY**

546 N. Marine Corps Dr., Tamuning, Guam 96913

T: 671-646-3111 | F: 671-649-3777

W: www.gswa.guam.gov**GSWA-004-24 Amendment No. 3.pdf**

35K

**PRE-SUBMISSION
CONFERENCE
MINUTES
N/A**

**PRE-SUBMISSION
CONFERENCE
ATTENDANCE LOG
N/A**

BIDDER'S WRITTEN QUESTIONS



GSWA Procurement <procurement@gswa.guam.gov>

GSWA-004-24 Compact Wheel Loader Questions

2 messages

Ryne Santos <rsantos@fareastequipment.com>
To: GSWA Procurement <procurement@gswa.guam.gov>
Cc: John Limtiaco <jlimtiaco@fareastequipment.com>

9 November 2023 at 10:51

Hafa Adai GSWA Procurement:

Please see below questions for the bid in subject.

1. In the specs under **Powertrain** the spec reads "Max rise and fall single wheel: 15 inch maximum, 14 inch minimum."
- Will 10 inches be acceptable?
2. In the specs under **Cooling** the spec reads "Hydraulically driven, proportionally controlled fan".
- Will direct driven be acceptable?
3. In the specs under **Hydraulics** the spec reads "Main pump (loader and steering): 18 GPM standard, 29 GPM with high flow option".
- Will a max rated flow 21.13 GPM @ 1,000 PSI be acceptable?
- Can you clarify why there is a request for high flow option when the requested attachments do not require high flow hydraulics?
4. In the specs under **Electrical** the spec reads "Battery capacity: 925 CCA"
- Will 830 CCA be acceptable?

--Best regards,
Ryne-Paul Santos
Sales
Far East Equipment Co. LLC
P.O. Box 10838
Tamuning, Guam 96931

**Far East
Equipment
Company**

GSWA Procurement <procurement@gswa.guam.gov>
To: Alicia Fejeran <alicia.fejeran@gswa.guam.gov>, Irvin Slike <irvin.slike@gswa.guam.gov>

9 November 2023 at 11:40

FYI.

11/9/2023 11:40 AM



GSWA Procurement <procurement@gswa.guam.gov>

GSWA-004-24: Compact Wheel Loader

Ryne Santos <rsantos@fareastequipment.com>

13 November 2023 at 13:28

To: GSWA Procurement <procurement@gswa.guam.gov>

Cc: John Limtiaco <jlimtiaco@fareastequipment.com>, Alicia Fejeran <alicia.fejeran@gswa.guam.gov>, Keilani Mesa <keilani.mesa@gswa.guam.gov>, Irvin Slike <irvin.slike@gswa.guam.gov>

Hafa Adai GSWA Procurement:

Please see attached signed and acknowledged Q&A Response. Please see additional inquiries below.

1. In regards to the high-flow hydraulics requirement for the broom attachment, John Deere's broom attachment does "NOT" require high-flow. Will high-flow still be required?
2. What Make and Model machine was used to form the specs of this bid?

Best regards,
Ryne

[View image as plain text](#)

P.O. Box 10838
Tamuning, Guam 96931

**Far East
Equipment
Company**

 **GSWA-004-24 Q&A Response 11.9.23 SIGNED.pdf**
328K



ADDRESS: 197 Ypao Road, Tamuning
Guam 96913
OFFICE Phone: 1-671-649-1946
FAX: 1-671-649-1947
SPARE PARTS: Phone: 1-671-646-7914
Fax: 1-671-646-7900
WEB: www.morricoequipment.com



November 15, 2023

MORRICO EQUIPMENT QUESTIONS

Irvin Slike
General Manager
Guam Solid Waste Authority
546 North Marine Corps Drive
Tamuning, Guam 96913

Re: Guam Solid Waste Authority Invitation for Bid GSWA-004-24 Compact Wheel Loader with Attachment

Dear Sir,
Morrico Equipment LLC submits the below questions in regards to Invitation for Bid No. GSWA-004-24 Compact Wheel Loader with Attachments Bid.

Specifications

1. Axles: Fixed, 100% differential, manually engaged front axle, fixed conventional differential rear axle.

Question # 1. Is an oscillating rear axle acceptable?

2. Max rise and fall single wheel: 15 inches maximum, 14 inch minimum.

Question # 2. Please clarify what is required by the term listed above.

3. Hydraulically Driven, proportionally controlled fan.

Question # 3. Will a belt driven fan be acceptable?

4. Voltage: 12 Volt

Question # 4. Will a 24 Volt Electrical System be Acceptable?

5. One (1) Battery

Question # 5. Will two 12 Volt Batteries be acceptable?

Page 1 of 2

ON-SITE DIESEL DELIVERY





ADDRESS: 197 Ypao Road, Tamuning, Guam 96913
OFFICE: Phone: 1-671-649-1946, FAX: 1-671-649-1947
SPARE PARTS: Phone: 1-671-646-7914, Fax: 1-671-646-7900
WEB: www.morricequipment.com



Re: Guam Solid Waste Authority Invitation for Bid GSWA-004-24 Compact Wheel Loader with Attachment

6. Battery Capacity: 925 CCA

Question # 6. Will two Batteries with 900 CCA be acceptable?

7. Seat: Air Ride high back with head rest and dual lumbar support

Question # 7. Will a mechanical suspension seat be acceptable?

8. 1.4 CY Bucket: 12,800 lbs. Maximum

Question # 8. Please confirm if this bucket request is for a multipurpose bucket.

9. One (1) 1.4 CY Bucket with Bolt on Cutting Edge

Question # 9. Please confirm if this bucket request is for a Multipurpose Bucket. Please confirm if this bucket request is additional to Question 8 bucket request or the same request.

Regards,

Paul Eustaquio
Heavy Equipment Sales
Morrice Equipment LLC
paul@morriceequipment.com
Cell: (671) 483-0180

ON-SITE DIESEL DELIVERY





GSWA Procurement <procurement@gswa.guam.gov>

Tink Claw Bucket - GSWA-004-24

Ryne Santos <rsantos@fareastequipment.com>
To: GSWA Procurement <procurement@gswa.guam.gov>
Cc: John Limtiaco <jlimtiaco@fareastequipment.com>

17 November 2023 at 12:46

Hafa Adai GSWA Procurement:

The manufacturer of the Tink Claw bucket does not recommend the C720 (2.7CYD) model for this size machine. They recommend the C520 (1.2 CYD) model for a machine of this size. With this information, does GSWA want to proceed with a C720 model bucket though it may pose a tipping hazard?

--Best regards,
Ryne-Paul Santos
Sales
Far East Equipment Co. LLC
P.O. Box 10838
Tamuning, Guam 96931



WRITTEN ANSWERS



GUAM SOLID WASTE AUTHORITY

LOURDES A. LEON GUERRERO
Governor of Guam

JOSHUA F. TENORIO
Lt. Governor of Guam

IRVIN L. SLIKE
General Manager



November 13, 2023

INVITATION FOR BID GSWA-004-24 COMPACT WHEEL LOADER W/ ATTACHMENTS

Questions and Concerns received from Far East Equipment Co. On November 9, 2023

1. In the specs under Powertrain, the spec reads "Max rise and fall single wheel: 15 inch maximum, 14 inch minimum." Will 10 inches be acceptable?

Response: No, specs remain the same.

2. In the specs under Cooling, the spec reads "Hydraulically driven, proportionally controlled fan." Will direct driven be acceptable?

Response: No, specs remain the same.

3. In the specs under Hydraulics, the spec reads "Main pump (loader and steering): 18 GPM standard, 29 GPM with high flow option." Will a max rated flow 21.13 GPM @ 1,000 PSI be acceptable?

Response: No, specs remain the same.

4. In the specs under Hydraulics, the spec reads "Main pump (loader and steering): 18 GPM standard, 29 GPM with high flow option." Can you clarify why there is a request for high flow option when the requested documents do not require high flow hydraulics?

Response: The pick-up broom specified requires the flow specified.

5. In the specs under Electrical, the spec reads "Battery capacity: 925 CCA." Will 830 CCA be acceptable?

Response: No, specs remain the same.

Irvin L. Slike,
General Manager

ACKNOWLEDGEMENT RECEIPT	
Return to GSWA by email or fax	
Received By: _____	_____
Date: _____	_____
Company Name: _____	_____
Fax to: 671-649-3777 Email: procurement@gswa.guam.gov	



GUAM SOLID WASTE AUTHORITY

LOURDES A. LEON GUERRERO
Governor of Guam

JOSHUA F. TENORIO
Lt. Governor of Guam

IRVIN L. SLIKE
General Manager



November 14, 2023

INVITATION FOR BID GSWA-004-24 COMPACT WHEEL LOADER W/ ATTACHMENTS

Questions and Concerns received from Far East Equipment Co. On November 13, 2023

1. In regards to the high-flow hydraulics requirement for the broom attachment, John Deere's broom attachment does "NOT" require high-flow. Will high-flow still be required?

Response: The hydraulic flow range is typical for brooms.

2. What make and model machine was used to form the specs of this bid?

Response: John Deere model 244P.

Irvin L. Slike,
General Manager

ACKNOWLEDGEMENT RECEIPT	
Return to GSWA by email or fax	
Received By:	_____
Date:	_____
Company Name:	_____
Fax to: 671-649-3777 Email: procurement@gswa.guam.gov	



GUAM SOLID WASTE AUTHORITY

LOURDES A. LEON GUERRERO
Governor of Guam

JOSHUA F. TENORIO
Lt. Governor of Guam

IRVIN L. SLIKE
General Manager



November 20, 2023

INVITATION FOR BID GSWA-004-24 COMPACT WHEEL LOADER W/ ATTACHMENTS

Questions and Concerns received from Morrico Equipment on November 15, 2023

1. Axles: Fixed, 100% differential, manually engaged front axle, fixed conventional differential rear axle. Is an oscillating rear axle acceptable?

Response: Yes, refer to Amendment No. 2.

2. Max rise and fall single wheel: 15 inches maximum, 14 inches minimum. Please clarify what is required by the term listed above.

Response: The term "Max rise and fall single wheel: 15 inches maximum, 14 inches minimum" pertains to the vertical movement capability of a single wheel on the compact wheel loader. Here's a breakdown of the requirement:

- **Max Rise:** This refers to the maximum vertical distance the center of a single wheel is allowed to move upward from its resting position. In this context, the specified maximum rise is 15 inches.
- **Min Fall:** Conversely, the minimum fall denotes the minimum vertical distance the center of a single wheel is permitted to move downward from its resting position. For this specification, the minimum fall is 14 inches.

These parameters are crucial for ensuring that the compact wheel loader can effectively navigate varied terrains, accommodate different load sizes, and maintain stability during operation.

3. Hydraulically Driven, proportionally controlled fan. Will a belt driven fan be acceptable?

Response: Yes, refer to Amendment No. 2.

4. Voltage: 12-volt. Will a 24 Volt Electrical System be acceptable?

Response: Yes, refer to Amendment No. 2.

5. One (1) Battery. Will two 12-volt batteries be acceptable?

Response: Yes, refer to Amendment No. 2.

6. Battery Capacity: 925 CCA. Will two batteries with 900 CCA be acceptable?

Response: Yes, refer to Amendment No. 2.



GUAM SOLID WASTE AUTHORITY

LOURDES A. LEON GUERRERO
Governor of Guam

JOSHUA F. TENORIO
Lt. Governor of Guam

IRVIN L. SLIKE
General Manager



7. Seat: Air Ride high back with head rest and dual lumbar support. Will a mechanical suspension seat be acceptable?

Response: Yes, refer to Amendment No. 2.

8. 1.4 CY Bucket: 12,800 lbs. Maximum. Please confirm if this bucket request is for a multipurpose bucket.

Response: Refer to Amendment No. 2.

9. One (1) 1.4 CY Bucket with Bolt on Cutting Edge. Please confirm if this bucket request is for a Multipurpose Bucket. Please confirm if this is bucket request is additional to Question 8 bucket request or the same request.

Response: Refer to Amendment No. 2.

Questions and Concerns received from Far East Equipment Co. on November 17, 2023

10. The manufacturer of the Tink Claw bucket does not recommend the C720 (2.7CYD) model for this size machine. They recommend the C520 (1.2CYD) model for a machine of this size. With this information, does GSWA want to proceed with a C720 model bucket though it may pose a tipping hazard?

Response: No, refer to Amendment No. 2.

Irvin L. Slike,
General Manager

ACKNOWLEDGEMENT RECEIPT	
Return to GSWA by email or fax.	
Received By:	_____
Date:	_____
Company Name:	_____
Fax to: 671-649-3777	
Email: procurement@gswa.guam.gov	

**PROOF OF WRITTEN
ANSWERS PROVIDED
TO BIDDERS**



GUAM SOLID WASTE AUTHORITY

LOURDES A. LEON GUERRERO

JOSHUA F. TENDRIO

IRVIN L. SLIKE



November 13, 2023

INVITATION FOR BID GSWA-004-24 COMPACT WHEEL LOADER W/ ATTACHMENTS

Questions and Concerns received from Far East Equipment Co. On November 9, 2023

1. In the specs under Powertrain, the spec reads "Max rise and fall single wheel: 15 inch maximum, 14 inch minimum." Will 10 inches be acceptable?

Response: No, specs remain the same.

2. In the specs under Cooling, the spec reads "Hydraulically driven, proportionally controlled fan." Will direct driven be acceptable?

Response: No, specs remain the same.

3. In the specs under Hydraulics, the spec reads "Main pump (loader and steering): 18 GPM standard, 29 GPM with high flow option." Will a max rated flow 21.13 GPM @ 1,000 PSI be acceptable?

Response: No, specs remain the same.

4. In the specs under Hydraulics, the spec reads "Main pump (loader and steering): 18 GPM standard, 29 GPM with high flow option." Can you clarify why there is a request for high flow option when the requested documents do not require high flow hydraulics?

Response: The pick-up broom specified requires the flow specified.

5. In the specs under Electrical, the spec reads "Battery capacity: 925 CCA." Will 830 CCA be acceptable?

Response: No, specs remain the same.

Irvin L. Slike,
General Manager

<p>ACKNOWLEDGEMENT RECEIPT <small>Returned to GSWA by email or fax</small></p> <p>Paul Eustaquio 11/15/23 Far East Equipment</p> <p>Fax to: 671 649 3777 Email: procurement@gswa.guam.gov</p>
--



GUAM SOLID WASTE AUTHORITY

LOURDES A. LEON GUERRERO

JOSHUA F. TENDRERO

IRVIN L. SLIKE



November 13, 2023

INVITATION FOR BID GSWA-004-24 COMPACT WHEEL LOADER W/ ATTACHMENTS

Questions and Concerns received from Far East Equipment Co. On November 9, 2023

1. In the specs under Powertrain, the spec reads "Max rise and fall single wheel: 15 inch maximum, 14 inch minimum." Will 10 inches be acceptable?

Response: No, specs remain the same.

2. In the specs under Cooling, the spec reads "Hydraulically driven, proportionally controlled fan." Will direct driven be acceptable?

Response: No, specs remain the same.

3. In the specs under Hydraulics, the spec reads "Main pump (loader and steering): 18 GPM standard, 29 GPM with high flow option." Will a max rated flow 21.13 GPM @ 1,000 PSI be acceptable?

Response: No, specs remain the same.

4. In the specs under Hydraulics, the spec reads "Main pump (loader and steering): 18 GPM standard, 29 GPM with high flow option." Can you clarify why there is a request for high flow option when the requested documents do not require high flow hydraulics?

Response: The pick-up broom specified requires the flow specified.

5. In the specs under Electrical, the spec reads "Battery capacity: 925 CCA." Will 830 CCA be acceptable?

Response: No, specs remain the same.

Irvin L. Slike,
General Manager

ACKNOWLEDGEMENT RECEIPT	
Received by GSWA by email for:	Ryno-Paul Santos <i>[Signature]</i>
Date:	11/13/23
Company Name:	Far East Equipment Co. LLC
Fax to: 671-649-3777	
Email: procurement@gswa.guam.gov	



GUAM SOLID WASTE AUTHORITY

LOURDES A. LEON GUERRERO

JOSHUA F. TENORIO

IRVIN L. SLIKE



November 13, 2023

INVITATION FOR BID GSWA-004-24 COMPACT WHEEL LOADER W/ ATTACHMENTS

Questions and Concerns received from Far East Equipment Co. On November 9, 2023

1. In the specs under Powertrain, the spec reads "Max rise and fall single wheel: 15 inch maximum, 14 inch minimum." Will 10 inches be acceptable?

Response: No, specs remain the same.

2. In the specs under Cooling, the spec reads "Hydraulically driven, proportionally controlled fan." Will direct driven be acceptable?

Response: No, specs remain the same.

3. In the specs under Hydraulics, the spec reads "Main pump (loader and steering): 18 GPM standard, 29 GPM with high flow option." Will a max rated flow 21.13 GPM @ 1,000 PSI be acceptable?

Response: No, specs remain the same.

4. In the specs under Hydraulics, the spec reads "Main pump (loader and steering): 18 GPM standard, 29 GPM with high flow option." Can you clarify why there is a request for high flow option when the requested documents do not require high flow hydraulics?

Response: The pick-up broom specified requires the flow specified.

5. In the specs under Electrical, the spec reads "Battery capacity: 925 CCA." Will 830 CCA be acceptable?

Response: No, specs remain the same.

Irvin L. Slike,
General Manager

ACKNOWLEDGEMENT RECEIPT	
Return to GSWA by email or fax	
Received by	Eddie Onopey
Date	11-13-2023
Company Name	USA Contractors, Inc.
Fax to: 671 649 3777	
Email: procurement@gswa.guam.gov	

GSWA-004-24: Compact Wheel Loader

1 message

GSWA Procurement <procurement@gswa.guam.gov>

13 November 2023 at 12:02

To: Jimmy Cruz <JPCRUZ@hawthornecat.com>

Cc: Alicia Fejeran <alicia.fejeran@gswa.guam.gov>, Keilani Mesa <keilani.mesa@gswa.guam.gov>, Irvin Slike <irvin.slike@gswa.guam.gov>

Håfa Adai!

Please see attached Questions & Concerns in regards to the above-mentioned IFB for your reference. Please sign the acknowledgement on the bottom of the page & submit back at your earliest convenience.

Thank you!

*Si Yu'os Ma'åse,***Camaryn Aguon****Buyer I****GUAM SOLID WASTE AUTHORITY**

546 N. Marine Corps Dr., Tamuning, Guam 96913

T: (671) 646-3111 | F: (671) 649-3777

W: www.gswa.guam.gov **GSWA-004-24 Q&C - 11.13.2023.pdf**
44K



GUAM SOLID WASTE AUTHORITY

LOUPOSS B. LEON GUERRERO

JOSHUA F. TENORIO

IRVIN L. SLIKE



November 14, 2023

INVITATION FOR BID GSWA-004-24 COMPACT WHEEL LOADER W/ ATTACHMENTS

Questions and Concerns received from Far East Equipment Co. On November 13, 2023

1. In regards to the high-flow hydraulics requirement for the broom attachment, John Deere's broom attachment does "NOT" require high flow. Will high-flow still be required?

Response: The hydraulic flow range is typical for brooms.

2. What make and model machine was used to form the specs of this bid?

Response: John Deere model 244P.

Irvin L. Slike,
General Manager

ACKNOWLEDGEMENT RECEIPT	
Received by _____	
Name	Paul Eustaquio
Date	11/15/23
Company Name	Marrico Equipment
Fax to: 671-649-3777	
Email: procurement@gswa.guam.gov	



GUAM SOLID WASTE AUTHORITY

LOURDES A. LEON GUERRERO

JOSHUA F. TENOREO

IRVIN L. SLIKE



November 14, 2023

INVITATION FOR BID GSWA-004-24 COMPACT WHEEL LOADER W/ ATTACHMENTS

Questions and Concerns received from Far East Equipment Co. On November 13, 2023

1. In regards to the high-flow hydraulics requirement for the broom attachment, John Deere's broom attachment does "NOT" require high-flow. Will high-flow still be required?

Response: The hydraulic flow range is typical for brooms.

2. What make and model machine was used to form the specs of this bid?

Response: John Deere model 244P.

Irvin L. Slike
General Manager

ACKNOWLEDGEMENT RECEIPT	
Received by	Ryno-Paul Santos
Date	11/14/22
Company Name	Far East Equipment Co. LLC
Fax to: 671-649-3777	
Email: procurement@gswa.guam.gov	



GUAM SOLID WASTE AUTHORITY

KOURDES A. LEON GUERRERO

JOSHUA F. TENORIO

IRVIN L. SLIKE



November 14, 2023

INVITATION FOR BID GSWA-004-24 COMPACT WHEEL LOADER W/ ATTACHMENTS

Questions and Concerns received from Far East Equipment Co. On November 13, 2023

1. In regards to the high-flow hydraulics requirement for the broom attachment, John Deere's broom attachment does "NOT" require high-flow. Will high-flow still be required?

Response: The hydraulic flow range is typical for brooms.

2. What make and model machine was used to form the specs of this bid?

Response: John Deere model 244P.

Irvin L. Slike
General Manager

ACKNOWLEDGEMENT RECEIPT

Return to GSWA by email or fax:

Received By: Eddie Onopey

Date: 11-16-2023

Company Name: USA CONTRACTORS, INC.

Fax to: 671-649-3777

Email: procurement@gswa.guam.gov

GSWA-004-24: Compact Wheel Loader w/ Attachments

1 message

GSWA Procurement <procurement@gswa.guam.gov>

14 November 2023 at 14:08

To: Jimmy Cruz <JPCRUZ@hawthornecat.com>

Cc: Alicia Fejeran <alicia.fejeran@gswa.guam.gov>, Keilani Mesa <keilani.mesa@gswa.guam.gov>

Håfa Adai!

Please see attached Questions & Concerns in regards to the above-mentioned IFB for your reference. Please sign the acknowledgement on the bottom of the page & submit back at your earliest convenience.

Thank you!

*Si Yu'os Ma'åse,***Camaryn Aguon****Buyer I****GUAM SOLID WASTE AUTHORITY**

546 N. Marine Corps Dr., Tamuning, Guam 96913

T: (671) 646-3111 | F: (671) 649-3777

W: www.gswa.guam.gov **GSWA-004-24 Q&C - 11.14.2023.pdf**
34K



GUAM SOLID WASTE AUTHORITY

LOURDES A. LEON GUERRERO

JOSHUA F. TENORIO

IRVIN L. SLIKE



November 20, 2023

INVITATION FOR BID GWSA-004-24 COMPACT WHEEL LOADER W/ ATTACHMENTS

Questions and Concerns received from Morrice Equipment on November 15, 2023

1. Axles: Fixed, 100% differential, manually engaged front axle, fixed conventional differential rear axle. Is an oscillating rear axle acceptable?

Response: Yes, refer to Amendment No. 2.

2. Max rise and fall single wheel: 15 inches maximum, 14 inches minimum. Please clarify what is required by the term listed above.

Response: The term "Max rise and fall single wheel: 15 inches maximum, 14 inches minimum" pertains to the vertical movement capability of a single wheel on the compact wheel loader. Here's a breakdown of the requirement:

- **Max Rise:** This refers to the maximum vertical distance the center of a single wheel is allowed to move upward from its resting position. In this context, the specified maximum rise is 15 inches.
- **Min Fall:** Conversely, the minimum fall denotes the minimum vertical distance the center of a single wheel is permitted to move downward from its resting position. For this specification, the minimum fall is 14 inches.

These parameters are crucial for ensuring that the compact wheel loader can effectively navigate varied terrains, accommodate different load sizes, and maintain stability during operation.

3. Hydraulically Driven, proportionally controlled fan. Will a belt driven fan be acceptable?

Response: Yes, refer to Amendment No. 2.

4. Voltage: 12-volt. Will a 24 Volt Electrical System be acceptable?

Response: Yes, refer to Amendment No. 2.

5. One (1) Battery. Will two 12-volt batteries be acceptable?

Response: Yes, refer to Amendment No. 2.

6. Battery Capacity: 925 CCA. Will two batteries with 900 CCA be acceptable?

Response: Yes, refer to Amendment No. 2.



GUAM SOLID WASTE AUTHORITY

LOURDES A. LEON GUERRERO

JOSHUA F. TEHORIO

IRVIN L. SLIKE



7. Seat: Air Ride high back with head rest and dual lumbar support. Will a mechanical suspension seat be acceptable?

Response: Yes, refer to Amendment No. 2.

8. 1.4 CY Bucket: 12,800 lbs. Maximum. Please confirm if this bucket request is for a multipurpose bucket.

Response: Refer to Amendment No. 2.

9. One (1) 1.4 CY Bucket with Bolt on Cutting Edge. Please confirm if this bucket request is for a Multipurpose Bucket. Please confirm if this is bucket request is additional to Question 8 bucket request or the same request.

Response: Refer to Amendment No. 2.

Questions and Concerns received from Far East Equipment Co. on November 17, 2023

10. The manufacturer of the Tink Claw bucket does not recommend the C720 (2.7CYD) model for this size machine. They recommend the C520 (1.2CYD) model for a machine of this size. With this information, does GSWA want to proceed with a C720 model bucket though it may pose a tipping hazard?

Response: No, refer to Amendment No. 2.

Irvin L. Slike,
General Manager

ACKNOWLEDGEMENT RECEIPT	
Return to: GSWA Procurement	
Received by:	Ryne Paul Santos
Date:	11/22/23
Company Name:	Far East Equipment Co. LLC
Fax to: 671-649-3777	
Email: procurement@gswa.guam.gov	

Transmission Report

Date/Time: 11-22-2023 01:13:02 p.m. Transmitt Header Text
 Local ID 1: 6714734370 Local Name 1: PUI

This document : Confirmed
 (reduced sample and details below)
 Document size : 8.5"x11"

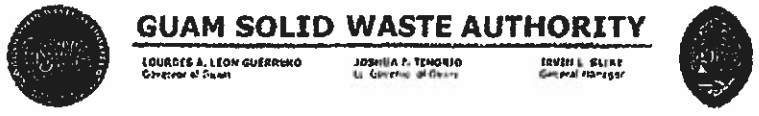

November 20, 2023

INVITATION FOR BID
GSWA-004-24
COMPACT WHEEL LOADER W/ ATTACHMENTS

Questions and Concerns received from Morrico Equipment on November 15, 2023

1. Axles: Fixed, 100% differential, manually engaged front axle, fixed conventional differential rear axle. Is an oscillating rear axle acceptable?

Response: Yes, refer to Amendment No. 2.

2. Max rise and fall single wheel: 15 inches maximum, 14 inches minimum. Please clarify what is required by the term listed above.

Response: The term "Max rise and fall single wheel: 15 inches maximum, 14 inches minimum" pertains to the vertical movement capability of a single wheel on the compact wheel loader. Here's a breakdown of the requirement:

- **Max Rise:** This refers to the maximum vertical distance the center of a single wheel is allowed to move upward from its resting position. In this context, the specified maximum rise is 15 inches.
- **Min Fall:** Conversely, the minimum fall denotes the minimum vertical distance the center of a single wheel is permitted to move downward from its resting position. For this specification, the minimum fall is 14 inches.

These parameters are crucial for ensuring that the compact wheel loader can effectively navigate varied terrains, accommodate different load sizes, and maintain stability during operation.

3. Hydraulically Driven, proportionally controlled fan. Will a belt driven fan be acceptable?

Response: Yes, refer to Amendment No. 2.

4. Voltage: 12-volt. Will a 24 Volt Electrical System be acceptable?

Response: Yes, refer to Amendment No. 2.

5. One (1) Battery. Will two 12-volt batteries be acceptable?

Response: Yes, refer to Amendment No. 2.

6. Battery Capacity: 925 CCA. Will two batteries with 900 CCA be acceptable?

Response: Yes, refer to Amendment No. 2.

546 N. MARINE CORPS DRIVE, TAMUNING, GU 96913 • TEL: 671-646-3111 | FAX: 671-649-3777
<https://www.guamsolidwasteauthority.com/>

Total Pages Scanned : 2			Total Pages Confirmed : 2							
No.	Job	Remote Station	Start Time	Duration	Pages	Line	Mode	Job Type	Results	
001	305	6716493777	01:12:10 p.m. 11-22-2023	00:00:27	2/2	1	EC	HS	CP28800	

Abbreviations:
 HS: Host send PL: Polled local MP: Mailbox print CP: Completed TS: Terminated by system
 HR: Host receive PR: Polled remote RP: Report FA: Fail G3: Group 3
 WS: Waiting send MS: Mailbox save FF: Fax Forward TU: Terminated by user EC: Error Correct



GUAM SOLID WASTE AUTHORITY

LOURDES A. LEON GUERRERO
Government Engineer

JOSHUA F. TENORIO
Chief Administrator

IRVIN L. SLIKE
Secretary



November 20, 2023

INVITATION FOR BID GSWA-004-24 COMPACT WHEEL LOADER W/ ATTACHMENTS

Questions and Concerns received from Morrigo Equipment on November 15, 2023

1. Axles: Fixed, 100% differential, manually engaged front axle, fixed conventional differential rear axle. Is an oscillating rear axle acceptable?

Response: Yes, refer to Amendment No. 2.

2. Max rise and fall single wheel: 15 inches maximum, 14 inches minimum. Please clarify what is required by the term listed above.

Response: The term "Max rise and fall single wheel: 15 inches maximum, 14 inches minimum" pertains to the vertical movement capability of a single wheel on the compact wheel loader. Here's a breakdown of the requirement:

- **Max Rise:** This refers to the maximum vertical distance the center of a single wheel is allowed to move upward from its resting position. In this context, the specified maximum rise is 15 inches.
- **Min Fall:** Conversely, the minimum fall denotes the minimum vertical distance the center of a single wheel is permitted to move downward from its resting position. For this specification, the minimum fall is 14 inches.

These parameters are crucial for ensuring that the compact wheel loader can effectively navigate varied terrains, accommodate different load sizes, and maintain stability during operation.

3. Hydraulically Driven, proportionally controlled fan. Will a belt driven fan be acceptable?

Response: Yes, refer to Amendment No. 2.

4. Voltage: 12-volt. Will a 24 Volt Electrical System be acceptable?

Response: Yes, refer to Amendment No. 2.

5. One (1) Battery. Will two 12-volt batteries be acceptable?

Response: Yes, refer to Amendment No. 2.

6. Battery Capacity: 925 CCA. Will two batteries with 900 CCA be acceptable?

Response: Yes, refer to Amendment No. 2.



GUAM SOLID WASTE AUTHORITY

LOURDES A. LEON GUERRERO
Governor of Guam

JOSHUA F. TENORIO
Lt. Governor of Guam

IRVIN L. SLIKE
General Manager



7. **Seat: Air Ride high back with head rest and dual lumbar support. Will a mechanical suspension seat be acceptable?**

Response: Yes, refer to Amendment No. 2.

8. **1.4 CY Bucket: 12,800 lbs. Maximum. Please confirm if this bucket request is for a multipurpose bucket.**

Response: Refer to Amendment No. 2.

9. **One (1) 1.4 CY Bucket with Bolt on Cutting Edge. Please confirm if this bucket request is for a Multipurpose Bucket. Please confirm if this is bucket request is additional to Question 8 bucket request or the same request.**

Response: Refer to Amendment No. 2.

Questions and Concerns received from Far East Equipment Co. on November 17, 2023

10. **The manufacturer of the Tink Claw bucket does not recommend the C720 (2.7CYD) model for this size machine. They recommend the C520 (1.2CYD) model for a machine of this size. With this information, does GSWA want to proceed with a C720 model bucket though it may pose a tipping hazard?**

Response: No, refer to Amendment No. 2.

Irvin L. Slike,
General Manager

ACKNOWLEDGEMENT RECEIPT	
Return to GSWA by email or fax	
Received By	Eddie Onopey
Date	November 21, 2023
Company Name	USA CONTRACTORS, INC.
Fax to: 671-649-3777	
Email: procurement@gswa.guam.gov	



GUAM SOLID WASTE AUTHORITY

LOURDES A. LEON GUERRERO
 Director of Region

JOSHUA F. TENORIO
 Director of Region

IRVIN L. SLIKE
 General Manager



November 20, 2023

INVITATION FOR BID GSWA-004-24 COMPACT WHEEL LOADER W/ ATTACHMENTS

Questions and Concerns received from Morrigo Equipment on November 15, 2023

1. Axles: Fixed, 100% differential, manually engaged front axle, fixed conventional differential rear axle. Is an oscillating rear axle acceptable?

Response: Yes, refer to Amendment No. 2.

2. Max rise and fall single wheel: 15 inches maximum, 14 inches minimum. Please clarify what is required by the term listed above.

Response: The term "Max rise and fall single wheel: 15 inches maximum, 14 inches minimum" pertains to the vertical movement capability of a single wheel on the compact wheel loader. Here's a breakdown of the requirement:

- **Max Rise:** This refers to the maximum vertical distance the center of a single wheel is allowed to move upward from its resting position. In this context, the specified maximum rise is 15 inches.
- **Min Fall:** Conversely, the minimum fall denotes the minimum vertical distance the center of a single wheel is permitted to move downward from its resting position. For this specification, the minimum fall is 14 inches.

These parameters are crucial for ensuring that the compact wheel loader can effectively navigate varied terrains, accommodate different load sizes, and maintain stability during operation.

3. Hydraulically Driven, proportionally controlled fan. Will a belt driven fan be acceptable?

Response: Yes, refer to Amendment No. 2.

4. Voltage: 12-volt. Will a 24 Volt Electrical System be acceptable?

Response: Yes, refer to Amendment No. 2.

5. One (1) Battery. Will two 12-volt batteries be acceptable?

Response: Yes, refer to Amendment No. 2.

6. Battery Capacity: 925 CCA. Will two batteries with 900 CCA be acceptable?

Response: Yes, refer to Amendment No. 2.



GUAM SOLID WASTE AUTHORITY

LOURDES A. LEON GUERRERO

JOSHUA F. TENORIO

IRVIN L. SLIKE



7. Seat: Air Ride high back with head rest and dual lumbar support. Will a mechanical suspension seat be acceptable?

Response: Yes, refer to Amendment No. 2.

8. 1.4 CY Bucket: 12,800 lbs. Maximum. Please confirm if this bucket request is for a multipurpose bucket.

Response: Refer to Amendment No. 2.

9. One (1) 1.4 CY Bucket with Bolt on Cutting Edge. Please confirm if this bucket request is for a Multipurpose Bucket. Please confirm if this is bucket request is additional to Question 8 bucket request or the same request.

Response: Refer to Amendment No. 2.

Questions and Concerns received from Far East Equipment Co. on November 17, 2023

10. The manufacturer of the Tink Claw bucket does not recommend the C720 (2.7CYD) model for this size machine. They recommend the C520 (1.2CYD) model for a machine of this size. With this information, does GSWA want to proceed with a C720 model bucket though it may pose a tipping hazard?

Response: No, refer to Amendment No. 2.

Irvin L. Slike,
General Manager

ACKNOWLEDGEMENT RECEIPT	
Return to GSWA by email or fax.	
Received By	Paul Eustaquio
Date	11/22/23
Company Name	Morrillo Equipment
Fax to: 671 649 3777	
Email: procurement@gswa.guam.gov	

GSWA-004-24: Compact Wheel Loader w/ Attachments

message

GSWA Procurement <procurement@gswa.guam.gov>

20 November 2023 at 17:09

To: Jimmy Cruz <JPCRUZ@hawthornecat.com>

Cc: Alicia Fejeran <alicia.fejeran@gswa.guam.gov>, Keilani Mesa <keilani.mesa@gswa.guam.gov>, Irvin Slike <irvin.slike@gswa.guam.gov>

Håfa Adai!

Please see attached documents for your reference:

- Questions & Concerns
- Amendment No. 2

Please sign the acknowledgement portion on the bottom of the page & submit back at your earliest convenience.

Thank you!

*Si Yu'os Ma'åse,***Camaryn Aguon****Buyer I****GUAM SOLID WASTE AUTHORITY**

546 N. Marine Corps Dr., Tamuning, Guam 96913

T: (671) 646-3111 | F: (671) 649-3777

W: www.gswa.guam.gov**2 attachments** **GSWA-004-24 Q&C - 11.20.2023.pdf**
81K **GSWA-004-24 Amendment No. 2.pdf**
156K

BIDDERS' PACKAGE SUBMISSION LOG

PROCUREMENT PACKAGES RECEIVED



GUAM SOLID WASTE AUTHORITY

LOURDES A. LEON GUERRERO
Governor of Guam

JOSHUA F. TENORIO
Lt. Governor of Guam

IRVIN L. SLIKE
General Manager



INVITATION FOR BID NO.: GSWA-004-24

DESCRIPTION: COMPACT WHEEL LOADER W/ ATTACHMENTS

SPECIAL REMINDER TO PROSPECTIVE BIDDERS

ORIGINAL

Bidders are reminded to read the Sealed Bid Solicitation and Instructions, and General Terms and Conditions attached to the IFB to ascertain that all of the following requirements checked below are submitted in the bid envelope, in duplicate, and the date and time for bid opening.

- (X) **BID GUARANTEE (15% of Bid Amount) May be in the form of;**
Reference #11 on the General Terms and Conditions
 - a. Cashier's Check or Certified Check
 - b. Letter of Credit
 - c. Surety Bond – Valid only if accompanied by:
 - 1. Current Certificate of Authority issued by the Insurance Commissioner;
 - 2. Power of Attorney issued by the Surety to the Resident General Agent;
 - 3. Power of Attorney issued by two (2) major officers of the Surety to whoever is signing on their behalf.

- (X) **BROCHURES/DESCRIPTIVE LITERATURE;**

- (X) **AFFIDAVIT DISCLOSING OWNERSHIP, INFLUENCE, COMMISSION, & CONFLICT OF INTEREST**
 - a. Date of signature of the person authorize to sign the bid and the notary date must be the same.

- (X) **OTHER REQUIREMENTS:**
Affidavit re Non-Collusion, Affidavit re No Gratuities or Kickbacks, Affidavit re Ethical Standards, Affidavit D.O.L. Wage Determination, Affidavit re Contingent Fees, Special Provision; Restriction Against Sexual Offenders

- (X) **CURRENT BUSINESS LICENSE / CONTRACTOR'S LICENSE / SPECIALTY LICENSE**
IN REFERENCE TO SUPPLIES OR SERVICES FOR THIS BID

This reminder must be signed and returned in the bid envelope together with the bid. Failure to comply with the above requirements may be cause for disqualification and rejection of bid.

On this 27th day of November, 2023, I Jesse Munoz, authorized representative of Morrice Equipment acknowledge receipt of this special reminder to prospective bidders with the above referenced IFB.

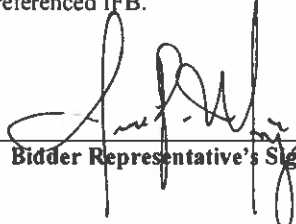

Bidder Representative's Signature



GUAM SOLID WASTE AUTHORITY

LOURDES A. LEON GUERRERO
Governor of Guam

JOSHUA F. TENDRIO
Lt. Governor of Guam

IRVIN L. SLIKE
General Manager



INVITATION FOR BID

ISSUING OFFICE:

IRVIN L. SLIKE
General Manager

10/31/23
DATE

GUAM SOLID WASTE AUTHORITY
546 NORTH MARINE CORPS DRIVE
TAMUNING, GUAM 96913

DATE ISSUED: 11/03/2023
BID INVITATION NO.: GSWA-004-24
BID FOR: COMPACT WHEEL LOADER W/ ATTACHMENTS
SPECIFICATION: SEE ATTACHED
DESTINATION: GUAM SOLID WASTE AUTHORITY
REQUIRED DELIVERY DATE: 200 DAYS UPON RECEIPT OF PURCHASE ORDER

INSTRUCTIONS TO BIDDERS:

INDICATE WHETHER: INDIVIDUAL PARTNERSHIP CORPORATION
INCORPORATED IN: _____ Limited Liability Corporation X

This bid shall be submitted in duplicate and sealed to the issuing office no later than (Time) **1:00PM**,
Date: **11/20/2023**, and shall be publicly opened. Bid submitted after the time and date specified above shall be rejected.
See attached General Terms and Conditions and Sealed Bid Solicitation for details.

The undersigned offers and agrees to furnish within the time specified, the articles and services at the price stated opposite the respective items listed on the schedule provided, unless otherwise specified by the bidder. In consideration to the expense of the Government in opening, tabulating, and evaluating this and other bids, and other considerations, the undersigned agrees that this bid remain firm and irrevocable within one hundred twenty (120) calendar days from the date opening to supply any or all the items which prices are quoted.

NAME AND ADDRESS OF BIDDER:
Morrico Equipment LLC
197 Ypao Road,
Tamuning, Guam 96913

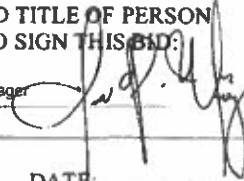
SIGNATURE AND TITLE OF PERSON
AUTHORIZED TO SIGN THIS BID:

Jesse Munoz Sales Manager

AWARD: CONTRACT NO.: _____ AMOUNT: _____ DATE: _____

ITEM NO(S). AWARDED: _____

CONTRACTING OFFICER:

IRVIN L. SLIKE DATE
General Manager

NAME AND ADDRESS OF CONTRACTOR:

SIGNATURE AND TITLE OF PERSON
AUTHORIZED TO SIGN THIS CONTRACT:

AFFIDAVIT DISCLOSING OWNERSHIP, INFLUENCE, COMMISSIONS AND CONFLICTS OF INTEREST

(Required by 5 GCA § 5233 as amended by P.L. 36-13 (4/9/2021))

CITY OF Tamuning)
) ss.
 ISLAND OF GUAM)

Preface. As a condition of submitting a Bid/Offer/Proposal or responding to any method of source selection under Guam's Procurement Law for the purpose of entering into a contract with the government of Guam, this Affidavit requires all Bidders/Offerors/Prospective Contractors to make disclosures of ownership, influence, commissions, gratuities, kickbacks, and conflicts of interest occurring **during the 365 calendar days preceding the publication of this solicitation and until award of a contract**. This includes the duty to disclose **any changes** to the facts disclosed herein throughout the solicitation process; and if the entity submitting this Affidavit is awarded a contract, the duty to disclose **any changes** to the facts disclosed herein **continues throughout the life of the contract, including any extensions or renewals**.

A I, the undersigned, being first duly sworn, depose and say that I am an authorized representative of the Bidder/Offeror/Prospective Contractor and that (please check and fill out all that apply):

The Bidder/Offeror/Prospective Contractor is an individual with a business license, and all decisions are by, and all profit is for, that same individual, with principal place of business street address being _____

The Bidder/Offeror/Prospective Contractor is a business or artificial person (as defined in 1 GCA § 715 or 5 GCA §§ 5030(n) or 5233(b)), and is a sole proprietorship owned entirely (100%) by _____, with principal place of business street address being _____

The Bidder/Offeror/Prospective Contractor is a business or artificial person (as defined in 1 GCA § 715 or 5 GCA §§ 5030(n) or 5233(b)), and is owned by the following multiple individuals. Note: owners of more than 10% are statutorily required to be listed below, but other owners of smaller percentage are encouraged to be listed as well.

Name of Owner	Principal Place of Business Street Address	% of Interest
<u>Atkin Kroll Inc.</u>	<u>443 South Marine Corps Drive, Tamuning, Guam 96913</u>	<u>100%</u>
_____	_____	_____
_____	_____	_____

Affidavit Disclosing Ownership, Influence,
Commissions and Conflicts of Interest
AG Procurement Form 002 (Rev. 11/17/2021)

- One or more of the more-than-10% owners listed above is a business or artificial person. Any more-than-25% owners of such a business or artificial person are listed below per 5 GCA § 5233. Note: any less-than-25% owners of such a business or artificial person is encouraged to also be listed below.

Name of >10% Owner Business or Artificial Person:

--

Names of owners of the >10% Owner Business or Artificial Person ("Second Tier Owner")	Owner's Principal Place of Business Street Address	% of Interest
Morrigo Equipment Holdings Inc.	197 Ypao Road, Tamuning Guam 96913	100%

Name of other >10% Owner Business or Artificial Person:

--

Names of owners of the >10% Owner Business or Artificial Person ("Second Tier Owner")	Owner's Principal Place of Business Street Address	% of Interest

- B If any Second Tier Owner identified above is an artificial person, the natural or artificial owners of such Second Tier Owner who have held more than 49% of the shares or interest in the Bidder/Offeror/Prospective Contractor (Third Tier Owners) are as follows [if none, please so state]:

Second Tier Owner Name _____

Name of Third Tier Owner	Principal Place of Business Street Address	% of Interest
_____	_____	_____
_____	_____	_____
_____	_____	_____
_____	_____	_____

Affidavit Disclosing Ownership, Influence,
Commissions and Conflicts of Interest
AG Procurement Form #02 (Rev. 11-17-2021)

C. If the name of no natural person has been identified as an owner, or a Second or Third Tier Owner of the Bidder/Offeror/Prospective Contractor, please identify the name, position, address, and contact information of the natural person having the authority and responsibility for the Bid/Offer/Proposal/Prospective Contract, and the name of any natural person who has the authority and power to remove and replace the designated responsible person.

Name of Natural Person	Position	Street Address of Principal Place of Business	Phone Number, Email Address, and other Contact Information
Jesse Munoz	Sales Manager	197 Ypao Road, Tamuning Guam 96913	Jesse.Munoz@morricequipment.com

D. Further, I say that the persons who have received or are entitled to receive a commission, gratuity, contingent fee or other compensation to solicit, secure, or assist in obtaining business related to the Bid/Offer/Proposal/Prospective Contract for which this Affidavit is submitted are as follows (if none, please so state):

Name	Principal Place of Business Street Address	Amount of Compensation
_____	_____	_____
_____	_____	_____

E. Further, I say that the persons who have directly or indirectly participated in this solicitation and who are also employees of the government of Guam or the government of the United States, if federal funds are to be used in the payment of the contract related to the Bid/Offer/Proposal/Prospective Contract for which this Affidavit is submitted, are as follows (if none, please so state):

Name	Principal Place of Business Street Address
_____	_____
_____	_____

F. Regardless of any ownership interest, the following individuals have the power to control the performance of the contract or to control the Bidder/Offeror/Prospective Contractor, directly or indirectly:

Name	Principal Place of Business Street Address
_____	_____
_____	_____

111
112

Affidavit Disclosing Ownership, Influence,
Commissions and Conflicts of Interest
AG Procurement Form 002 (Rev. 11-17-2021)

G. Until award of the contract, and throughout the term of any contract awarded to the Bidder/Offeror/Prospective Contractor represented herein, I agree to promptly make any disclosures not made previously and update changes in ownership, identities of owners and other required information, interests, compensation or conflicts of the persons required to be disclosed. I understand that failure to comply with this requirement shall constitute a material breach of contract.

H. I hereby declare under penalty of perjury under the laws of Guam that the foregoing is true and correct.

Executed on November 27, 2023
(date)

Jesse Munoz Sales Manager

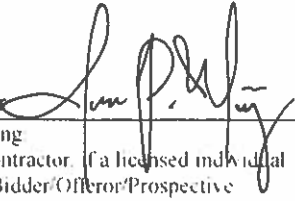

Signature of one of the following:
Bidder/Offeror/Prospective Contractor, if a licensed individual
Owner of sole proprietorship Bidder/Offeror/Prospective
Contractor
Partner, if the Bidder/Offeror/Prospective Contractor is a
partnership
Officer, if the Bidder/Offeror/Prospective Contractor is a
corporation

Subscribed and sworn to before me

This 27th day of November, 2023

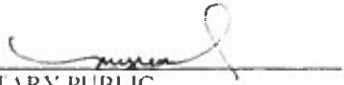

NOTARY PUBLIC

My commission expires: DECEMBER 02, 2024

MARY ROSE S. REAL
NOTARY PUBLIC
In and for Guam, U.S.A.
My Commission Expires: **DEC. 02, 2024**
P.O. Box 167 Hagatna, Guam 96932

AFFIDAVIT RE NON-COLLUSION

CITY OF Tamuning)
) SS.
ISLAND OF GUAM)

Jesse Munoz [state name of affiant signing below], being first duly sworn, deposes and says that:

1. The name of the offering company or individual is [state name of company]
Morroco Equipment LLC

2. The proposal for the solicitation identified above is genuine and not collusive or a sham. The offeror has not colluded, conspired, connived or agreed, directly or indirectly, with any other offeror or person, to put in a sham proposal or to refrain from making an offer. The offeror has not in any manner, directly or indirectly, sought by an agreement or collusion, or communication or conference, with any person to fix the proposal price of offeror or of any other offeror, or to fix any overhead, profit or cost element of said proposal price, or of that of any other offeror, or to secure any advantage against the government of Guam or any other offeror, or to secure any advantage against the government of Guam or any person interested in the proposed contract. All statements in this affidavit and in the proposal are true to the best of the knowledge of the undersigned. This statement is made pursuant to 2 GAR Division 4 § 3126(b)

3. I make this statement on behalf of myself as a representative of the offeror, and on behalf of the offeror's officers, representatives, agents, subcontractors, and employees.

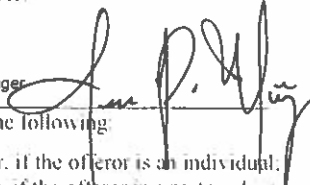
Jesse Munoz Sales Manager 
Signature of one of the following:
Offeror, if the offeror is an individual.
Partner, if the offeror is a partnership.
Officer, if the offeror is a corporation.

Subscribed and sworn to before me
this 27th day of November, 2023.

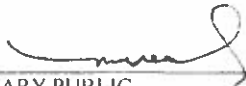
NOTARY PUBLIC
My commission expires December 02, 2024

AG Procurement Form 003 (Jul. 12, 2010)

MARY ROSE S. REAL
NOTARY PUBLIC
In and for Guam, U.S.A.
My Commission Expires: **DEC. 02, 2024**
P.O. Box 167 Hagatna, Guam 96932

AFFIDAVIT re NO GRATUITIES or KICKBACKS

CITY OF Tamuning)
) ss.
ISLAND OF GUAM)

Jesse Munoz [state name of affiant signing below], being first duly sworn, deposes and says that:

1. The name of the offering firm or individual is [state name of offeror company] Morrice Equipment LLC. Affiant is an Officer of the offeror [state one of the following: the offeror, a partner of the offeror, an officer of the offeror] making the foregoing identified bid or proposal.

2. To the best of affiant's knowledge, neither affiant, nor any of the offeror's officers, representatives, agents, subcontractors, or employees have violated, are violating the prohibition against gratuities and kickbacks set forth in 2 GAR Division 4 § 11107(e). Further, affiant promises, on behalf of offeror, not to violate the prohibition against gratuities and kickbacks as set forth in 2 GAR Division 4 § 11107(e).

3. To the best of affiant's knowledge, neither affiant, nor any of the offeror's officers, representatives, agents, subcontractors, or employees have offered, given or agreed to give, any government of Guam employee or former government employee, any payment, gift, kickback, gratuity or offer of employment in connection with the offeror's proposal.

4. I make these statements on behalf of myself as a representative of the offeror, and on behalf of the offeror's officers, representatives, agents, subcontractors, and employees.

Jesse Munoz Sales Manager

Signature of one of the following:

Offeror, if the offeror is an individual;
Partner, if the offeror is a partnership;
Officer, if the offeror is a corporation.

Subscribed and sworn to before me

this 27th day of November, ~~200~~ ²⁰²³

NOTARY PUBLIC

My commission expires ~~DECEMBER 02~~ ²⁰²⁴.

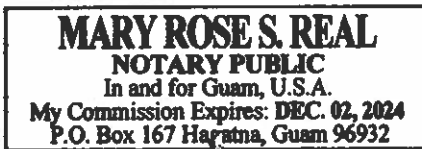

AFFIDAVIT RE ETHICAL STANDARDS

CITY OF Tamuning)
) ss.
ISLAND OF GUAM)

Jesse Munoz [state name of affiant signing below], being first
duly sworn, deposes and says that:

The affiant is an Officer of the offeror [state one of the following: the offeror,
a partner of the offeror, an officer of the offeror] making the foregoing identified bid or proposal. To the
best of affiant's knowledge, neither affiant nor any officers, representatives, agents, subcontractors or
employees of offeror have knowingly influenced any government of Guam employee to breach any of the
ethical standards set forth in 5 GCA Chapter 5, Article 11. Further, affiant promises that neither he or
she, nor any officer, representative, agent, subcontractor, or employee of offeror will knowingly
influence any government of Guam employee to breach any ethical standards set forth in 5 GCA Chapter
5, Article 11. These statements are made pursuant to 2 GAR Division 4 § 11103(b).

Jesse Munoz Sales Manager
Signature of one of the following:
Offeror, if the offeror is an individual
Partner, if the offeror is a partnership
Officer, if the offeror is a corporation.

Subscribed and sworn to before me
this 27th day of November, 201, 2023

[Signature]
NOTARY PUBLIC
My commission expires DECEMBER 02, 2024.

MARY ROSE S. REAL
NOTARY PUBLIC
In and for Guam, U.S.A.
My Commission Expires: **DEC. 02, 2024**
P.O. Box 167 Hagatna, Guam 96932

DECLARATION RE COMPLIANCE WITH U.S. DOL WAGE DETERMINATION

Procurement No.: GSWA-004-24

Name of Offeror Company: Morrco Equipment LLC

I, Jesse Munoz hereby certify under penalty of perjury:

(1) That I am an Officer of the offeror [please select one: the offeror, a partner of the offeror, an officer of the offeror] making the bid or proposal in the foregoing identified procurement.

(2) That I have read and understand the provisions of 5 GCA § 5801 and § 5802 which read:

§ 5801. Wage Determination Established.

In such cases where the government of Guam enters into contractual arrangements with a sole proprietorship, a partnership or a corporation ("contractor") for the provision of a service to the government of Guam, and in such cases where the contractor employs a person(s) whose purpose, in whole or in part, is the direct delivery of service contracted by the government of Guam, then the contractor shall pay such employee(s) in accordance with the Wage Determination for Guam and the Northern Mariana Islands issued and promulgated by the U.S. Department of Labor for such labor as is employed in the direct delivery of contract deliverables to the government of Guam.

The Wage Determination most recently issued by the U.S. Department of Labor at the time a contract is awarded to a contractor by the government of Guam shall be used to determine wages, which shall be paid to employees pursuant to this Article. Should any contract contain a renewal clause, then at the time of renewal adjustments, there shall be made stipulations contained in that contract for applying the Wage Determination, as required by this Article, so that the Wage Determination promulgated by the U.S. Department of Labor on a date most recent to the renewal date shall apply.

§ 5802. Benefits.

In addition to the Wage Determination detailed in this Article, any contract to which this Article applies shall also contain provisions mandating health and similar benefits for employees covered by this Article, such benefits having a minimum value as detailed in the Wage Determination issued and promulgated by the U.S. Department of Labor, and shall contain provisions guaranteeing a minimum of ten (10) paid holidays per annum per employee.

(3) That the offeror is in full compliance with 5 GCA § 5801 and § 5802, as may be applicable to the procurement referenced herein.

(4) That I have attached the most recent wage determination applicable to Guam issued by the U.S. Department of Labor. [INSTRUCTIONS - Please attach!]

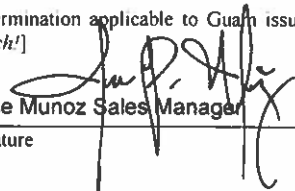
Jesse Munoz Sales Manager
Signature

GSWA PROCUREMENT RECORD Page 115

*REGISTER OF WAGE DETERMINATIONS UNDER THE SERVICE CONTRACT ACT By direction of the Secretary of Labor	U.S. DEPARTMENT OF LABOR EMPLOYMENT STANDARDS ADMINISTRATION WAGE AND HOUR DIVISION WASHINGTON D.C. 20210
--	--

Daniel W. Simms Director	Division of Wage Determinations	Wage Determination No.: 2015-5693 Revision No.: 19 Date Of Last Revision: 07/17/2023
-----------------------------	------------------------------------	--

Note: Contracts subject to the Service Contract Act are generally required to pay at least the applicable minimum wage rate required under Executive Order 14026.

If the contract is entered into on or after January 30, 2022, or the contract is renewed or extended (e.g., an option is exercised) on or after January 30, 2022:	Executive Order 14026 generally applies to the contract. The contractor must pay all covered workers at least \$16.20 per hour (or the applicable wage rate listed on this wage determination, if it is higher) for all hours spent performing on the contract in 2023.
---	--

The applicable Executive Order minimum wage rate will be adjusted annually. Additional information on contractor requirements and worker protections under the Executive Orders is available at www.dol.gov/whd/govcontracts.

States: Guam, Northern Marianas, Wake Island

Area: Guam Statewide
 Northern Marianas Statewide
 Wake Island Statewide

****Fringe Benefits Required Follow the Occupational Listing****

OCCUPATION CODE - TITLE	FOOTNOTE	RATE
01000 - Administrative Support And Clerical Occupations		
01011 - Accounting Clerk I		14.27***
01012 - Accounting Clerk II		16.02***
01013 - Accounting Clerk III		17.93
01020 - Administrative Assistant		21.43
01035 - Court Reporter		17.40
01041 - Customer Service Representative I		12.75***
01042 - Customer Service Representative II		14.23***
01043 - Customer Service Representative III		15.62***
01051 - Data Entry Operator I		12.16***
01052 - Data Entry Operator II		13.27***
01060 - Dispatcher, Motor Vehicle		17.39
01070 - Document Preparation Clerk		13.85***
01090 - Duplicating Machine Operator		13.85***
01111 - General Clerk I		11.33***
01112 - General Clerk II		12.36***
01113 - General Clerk III		13.88***
01120 - Housing Referral Assistant		19.39
01141 - Messenger Courier		11.37***
01191 - Order Clerk I		12.57***
01192 - Order Clerk II		13.71***
01261 - Personnel Assistant (Employment) I		15.95***
01262 - Personnel Assistant (Employment) II		17.85
01263 - Personnel Assistant (Employment) III		19.89
01270 - Production Control Clerk		22.97
01290 - Rental Clerk		11.10***
01300 - Scheduler, Maintenance		15.55***
01311 - Secretary I		15.55***
01312 - Secretary II		17.40
01313 - Secretary III		19.39
01320 - Service Order Dispatcher		15.40***
01410 - Supply Technician		21.43
01420 - Survey Worker		16.96
01460 - Switchboard Operator/Receptionist		10.78***
01531 - Travel Clerk I		13.01***
01532 - Travel Clerk II		14.12***
01533 - Travel Clerk III		15.09***
01611 - Word Processor I		14.53***

GSWA PROCUREMENT RECORD Page 116

01612 - Word Processor II	16.31
01613 - Word Processor III	18.26
05000 - Automotive Service Occupations	
05005 - Automobile Body Repairer, Fiberglass	17.20
05010 - Automotive Electrician	16.16***
05040 - Automotive Glass Installer	15.11***
05070 - Automotive Worker	15.11***
05110 - Mobile Equipment Servicer	12.96***
05130 - Motor Equipment Metal Mechanic	17.20
05160 - Motor Equipment Metal Worker	15.11***
05190 - Motor Vehicle Mechanic	17.20
05220 - Motor Vehicle Mechanic Helper	11.87***
05250 - Motor Vehicle Upholstery Worker	14.06***
05280 - Motor Vehicle Wrecker	15.11***
05310 - Painter, Automotive	16.16***
05340 - Radiator Repair Specialist	15.11***
05370 - Tire Repairer	12.67***
05400 - Transmission Repair Specialist	17.20
07000 - Food Preparation And Service Occupations	
07010 - Baker	11.10***
07041 - Cook I	14.44***
07042 - Cook II	16.84
07070 - Dishwasher	9.69***
07130 - Food Service Worker	10.11***
07210 - Meat Cutter	13.34***
07260 - Waiter/Waitress	9.73***
09000 - Furniture Maintenance And Repair Occupations	
09010 - Electrostatic Spray Painter	18.75
09040 - Furniture Handler	11.37***
09080 - Furniture Refinisher	18.75
09090 - Furniture Refinisher Helper	13.77***
09110 - Furniture Repairer, Minor	16.32
09130 - Upholsterer	18.75
11000 - General Services And Support Occupations	
11030 - Cleaner, Vehicles	9.69***
11060 - Elevator Operator	9.69***
11090 - Gardener	14.28***
11122 - Housekeeping Aide	10.13***
11150 - Janitor	10.13***
11210 - Laborer, Grounds Maintenance	10.79***
11240 - Maid or Houseman	9.67***
11260 - Pruner	9.66***
11270 - Tractor Operator	13.07***
11330 - Trail Maintenance Worker	10.79***
11360 - Window Cleaner	11.32***
12000 - Health Occupations	
12010 - Ambulance Driver	18.96
12011 - Breath Alcohol Technician	18.96
12012 - Certified Occupational Therapist Assistant	26.02
12015 - Certified Physical Therapist Assistant	26.02
12020 - Dental Assistant	18.79
12025 - Dental Hygienist	39.73
12030 - EKG Technician	28.73
12035 - Electroneurodiagnostic Technologist	28.73
12040 - Emergency Medical Technician	18.96
12071 - Licensed Practical Nurse I	16.95
12072 - Licensed Practical Nurse II	18.96
12073 - Licensed Practical Nurse III	21.14
12100 - Medical Assistant	13.42***
12130 - Medical Laboratory Technician	18.82
12160 - Medical Record Clerk	14.97***
12190 - Medical Record Technician	17.77
12195 - Medical Transcriptionist	16.95
12210 - Nuclear Medicine Technologist	41.68
12221 - Nursing Assistant I	12.43***
12222 - Nursing Assistant II	13.97***
12223 - Nursing Assistant III	15.24***
12224 - Nursing Assistant IV	17.12
12235 - Optical Dispenser	18.96
12236 - Optical Technician	16.95
12250 - Pharmacy Technician	15.49***
12280 - Phlebotomist	16.95
12305 - Radiologic Technologist	28.73
12311 - Registered Nurse I	23.50
12312 - Registered Nurse II	28.73
12313 - Registered Nurse II, Specialist	28.73
12314 - Registered Nurse III	34.76
12315 - Registered Nurse III, Anesthetist	34.76
12316 - Registered Nurse IV	41.68
12317 - Scheduler (Drug and Alcohol Testing)	23.50

12320 - Substance Abuse Treatment Counselor	23.50
13000 - Information And Arts Occupations	
13011 - Exhibits Specialist I	21.42
13012 - Exhibits Specialist II	26.53
13013 - Exhibits Specialist III	32.45
13041 - Illustrator I	21.42
13042 - Illustrator II	26.53
13043 - Illustrator III	32.45
13047 - Librarian	29.38
13050 - Library Aide/Clerk	17.05
13054 - Library Information Technology Systems Administrator	26.53
13058 - Library Technician	18.11
13061 - Media Specialist I	19.15
13062 - Media Specialist II	21.42
13063 - Media Specialist III	23.87
13071 - Photographer I	19.15
13072 - Photographer II	21.42
13073 - Photographer III	26.53
13074 - Photographer IV	32.45
13075 - Photographer V	39.27
13090 - Technical Order Library Clerk	21.42
13110 - Video Teleconference Technician	19.15
14000 - Information Technology Occupations	
14041 - Computer Operator I	15.71***
14042 - Computer Operator II	17.22
14043 - Computer Operator III	19.19
14044 - Computer Operator IV	21.33
14045 - Computer Operator V	23.62
14071 - Computer Programmer I	(see 1) 15.73***
14072 - Computer Programmer II	(see 1) 19.50
14073 - Computer Programmer III	(see 1) 23.84
14074 - Computer Programmer IV	(see 1)
14101 - Computer Systems Analyst I	(see 1) 24.23
14102 - Computer Systems Analyst II	(see 1)
14103 - Computer Systems Analyst III	(see 1)
14150 - Peripheral Equipment Operator	15.71***
14160 - Personal Computer Support Technician	21.33
14170 - System Support Specialist	21.24
15000 - Instructional Occupations	
15010 - Aircrew Training Devices Instructor (Non-Rated)	24.23
15020 - Aircrew Training Devices Instructor (Rated)	29.32
15030 - Air Crew Training Devices Instructor (Pilot)	34.91
15050 - Computer Based Training Specialist / Instructor	24.23
15060 - Educational Technologist	29.40
15070 - Flight Instructor (Pilot)	34.91
15080 - Graphic Artist	20.47
15085 - Maintenance Test Pilot, Fixed, Jet/Prop	34.91
15086 - Maintenance Test Pilot, Rotary Wing	34.91
15088 - Non-Maintenance Test/Co-Pilot	34.91
15090 - Technical Instructor	17.67
15095 - Technical Instructor/Course Developer	23.78
15110 - Test Proctor	15.70***
15120 - Tutor	15.70***
16000 - Laundry, Dry-Cleaning, Pressing And Related Occupations	
16010 - Assembler	10.83***
16030 - Counter Attendant	10.83***
16040 - Dry Cleaner	12.36***
16070 - Finisher, Flatwork, Machine	10.83***
16090 - Presser, Hand	10.83***
16110 - Presser, Machine, Drycleaning	10.83***
16130 - Presser, Machine, Shirts	10.83***
16160 - Presser, Machine, Wearing Apparel, Laundry	10.83***
16190 - Sewing Machine Operator	12.88***
16220 - Tailor	13.40***
16250 - Washer, Machine	11.34***
19000 - Machine Tool Operation And Repair Occupations	
19010 - Machine-Tool Operator (Tool Room)	19.46
19040 - Tool And Die Maker	24.46
21000 - Materials Handling And Packing Occupations	
21020 - Forklift Operator	15.36***
21030 - Material Coordinator	22.97
21040 - Material Expediter	22.97
21050 - Material Handling Laborer	12.57***
21071 - Order Filler	10.62***
21080 - Production Line Worker (Food Processing)	15.36***
21110 - Shipping Packer	17.12
21130 - Shipping/Receiving Clerk	17.12
21140 - Store Worker I	15.83***
21150 - Stock Clerk	22.26

GSWA PROCUREMENT RECORD Page 118

21210 - Tools And Parts Attendant	15.36***
21410 - Warehouse Specialist	15.36***
23000 - Mechanics And Maintenance And Repair Occupations	
23010 - Aerospace Structural Welder	25.04
23019 - Aircraft Logs and Records Technician	19.47
23021 - Aircraft Mechanic I	23.84
23022 - Aircraft Mechanic II	25.04
23023 - Aircraft Mechanic III	26.30
23040 - Aircraft Mechanic Helper	16.58
23050 - Aircraft, Painter	22.39
23060 - Aircraft Servicer	19.47
23070 - Aircraft Survival Flight Equipment Technician	22.39
23080 - Aircraft Worker	21.03
23091 - Aircrew Life Support Equipment (ALSE) Mechanic I	21.03
23092 - Aircrew Life Support Equipment (ALSE) Mechanic II	23.84
23110 - Appliance Mechanic	19.46
23120 - Bicycle Repairer	15.61***
23125 - Cable Splicer	22.47
23130 - Carpenter, Maintenance	17.58
23140 - Carpet Layer	18.20
23160 - Electrician, Maintenance	19.37
23181 - Electronics Technician Maintenance I	18.20
23182 - Electronics Technician Maintenance II	19.46
23183 - Electronics Technician Maintenance III	20.72
23260 - Fabric Worker	16.94
23290 - Fire Alarm System Mechanic	16.77
23310 - Fire Extinguisher Repairer	15.61***
23311 - Fuel Distribution System Mechanic	20.72
23312 - Fuel Distribution System Operator	15.61***
23370 - General Maintenance Worker	13.24***
23380 - Ground Support Equipment Mechanic	23.84
23381 - Ground Support Equipment Servicer	19.47
23382 - Ground Support Equipment Worker	21.03
23391 - Gunsmith I	15.61***
23392 - Gunsmith II	18.20
23393 - Gunsmith III	20.72
23410 - Heating, Ventilation And Air-Conditioning Mechanic	19.27
23411 - Heating, Ventilation And Air Contidioning Mechanic (Research Facility)	20.50
23430 - Heavy Equipment Mechanic	19.50
23440 - Heavy Equipment Operator	18.10
23460 - Instrument Mechanic	20.72
23465 - Laboratory/Shelter Mechanic	19.46
23470 - Laborer	12.57***
23510 - Locksmith	19.46
23530 - Machinery Maintenance Mechanic	23.13
23550 - Machinist, Maintenance	20.72
23580 - Maintenance Trades Helper	11.77***
23591 - Metrology Technician I	20.72
23592 - Metrology Technician II	22.03
23593 - Metrology Technician III	23.33
23640 - Millwright	20.72
23710 - Office Appliance Repairer	19.46
23760 - Painter, Maintenance	17.04
23790 - Pipefitter, Maintenance	19.96
23810 - Plumber, Maintenance	18.75
23820 - Pneudraulic Systems Mechanic	20.72
23850 - Rigger	20.72
23870 - Scale Mechanic	18.20
23890 - Sheet-Metal Worker, Maintenance	19.55
23910 - Small Engine Mechanic	18.20
23931 - Telecommunications Mechanic I	19.96
23932 - Telecommunications Mechanic II	21.24
23950 - Telephone Lineman	20.62
23960 - Welder, Combination, Maintenance	19.96
23965 - Well Driller	21.13
23970 - Woodcraft Worker	20.71
23980 - Woodworker	15.61***
24000 - Personal Needs Occupations	
24550 - Case Manager	15.01***
24570 - Child Care Attendant	10.09***
24580 - Child Care Center Clerk	13.25***
24610 - Chore Aide	14.06***
24620 - Family Readiness And Support Services Coordinator	15.01***
24630 - Homemaker	16.12***
25000 - Plant And System Operations Occupations	

GSWA PROCUREMENT RECORD Page 119

25010 - Boiler Tender	22.79
25040 - Sewage Plant Operator	22.89
25070 - Stationary Engineer	22.79
25190 - Ventilation Equipment Tender	15.72***
25210 - Water Treatment Plant Operator	22.89
27000 - Protective Service Occupations	
27004 - Alarm Monitor	10.90***
27007 - Baggage Inspector	9.63***
27008 - Corrections Officer	14.59***
27010 - Court Security Officer	14.59***
27030 - Detection Dog Handler	10.90***
27040 - Detention Officer	14.59***
27070 - Firefighter	14.59***
27101 - Guard I	9.63***
27102 - Guard II	10.90***
27131 - Police Officer I	14.59***
27132 - Police Officer II	16.21
28000 - Recreation Occupations	
28041 - Carnival Equipment Operator	13.24***
28042 - Carnival Equipment Repairer	14.46***
28043 - Carnival Worker	9.78***
28210 - Gate Attendant/Gate Tender	13.18***
28310 - Lifeguard	11.01***
28350 - Park Attendant (Aide)	14.74***
28510 - Recreation Aide/Health Facility Attendant	11.84***
28515 - Recreation Specialist	18.26
28630 - Sports Official	11.74***
28690 - Swimming Pool Operator	17.71
29000 - Stevedoring/Longshoremen Occupational Services	
29010 - Blocker And Bracer	26.02
29020 - Hatch Tender	26.02
29030 - Line Handler	26.02
29041 - Stevedore I	24.21
29042 - Stevedore II	27.82
30000 - Technical Occupations	
30010 - Air Traffic Control Specialist, Center (HFO) (see 2)	43.06
30011 - Air Traffic Control Specialist, Station (HFO) (see 2)	29.69
30012 - Air Traffic Control Specialist, Terminal (HFO) (see 2)	32.70
30021 - Archeological Technician I	18.17
30022 - Archeological Technician II	20.33
30023 - Archeological Technician III	25.19
30030 - Cartographic Technician	25.19
30040 - Civil Engineering Technician	25.19
30051 - Cryogenic Technician I	27.89
30052 - Cryogenic Technician II	30.80
30061 - Drafter/CAD Operator I	18.17
30062 - Drafter/CAD Operator II	20.33
30063 - Drafter/CAD Operator III	22.66
30064 - Drafter/CAD Operator IV	27.89
30081 - Engineering Technician I	16.19***
30082 - Engineering Technician II	18.17
30083 - Engineering Technician III	20.33
30084 - Engineering Technician IV	25.19
30085 - Engineering Technician V	30.80
30086 - Engineering Technician VI	37.27
30090 - Environmental Technician	25.19
30095 - Evidence Control Specialist	25.19
30210 - Laboratory Technician	22.66
30221 - Latent Fingerprint Technician I	27.89
30222 - Latent Fingerprint Technician II	30.80
30240 - Mathematical Technician	25.19
30361 - Paralegal/Legal Assistant I	19.54
30362 - Paralegal/Legal Assistant II	24.21
30363 - Paralegal/Legal Assistant III	29.61
30364 - Paralegal/Legal Assistant IV	35.83
30375 - Petroleum Supply Specialist	30.80
30390 - Photo-Optics Technician	24.92
30395 - Radiation Control Technician	30.80
30461 - Technical Writer I	25.19
30462 - Technical Writer II	30.80
30463 - Technical Writer III	37.27
30491 - Unexploded Ordnance (UXO) Technician I	27.37
30492 - Unexploded Ordnance (UXO) Technician II	33.11
30493 - Unexploded Ordnance (UXO) Technician III	39.69
30494 - Unexploded (UXO) Safety Escort	27.37
30495 - Unexploded (UXO) Sweep Personnel	27.37
30501 - Weather Forecaster I	27.89
30502 - Weather Forecaster II	33.93
30620 - Weather Observer, Combined Upper Air Or Surface Programs (see 2)	22.66

GSWA PROCUREMENT RECORD Page 120

30621 - Weather Observer, Senior	(see 2)	25.19
31000 - Transportation/Mobile Equipment Operation Occupations		
31010 - Airplane Pilot		33.11
31020 - Bus Aide		8.97***
31030 - Bus Driver		11.73***
31043 - Driver Courier		10.26***
31260 - Parking and Lot Attendant		9.91***
31290 - Shuttle Bus Driver		11.65***
31310 - Taxi Driver		11.41***
31361 - Truckdriver, Light		11.21***
31362 - Truckdriver, Medium		12.16***
31363 - Truckdriver, Heavy		16.11***
31364 - Truckdriver, Tractor-Trailer		16.11***
99000 - Miscellaneous Occupations		
99020 - Cabin Safety Specialist		16.14***
99030 - Cashier		10.01***
99050 - Desk Clerk		9.71***
99095 - Embalmer		27.37
99130 - Flight Follower		27.37
99251 - Laboratory Animal Caretaker I		24.31
99252 - Laboratory Animal Caretaker II		26.56
99260 - Marketing Analyst		21.54
99310 - Mortician		27.37
99410 - Pest Controller		16.07***
99510 - Photofinishing Worker		14.38***
99710 - Recycling Laborer		17.32
99711 - Recycling Specialist		23.38
99730 - Refuse Collector		16.40
99810 - Sales Clerk		10.63***
99820 - School Crossing Guard		17.96
99830 - Survey Party Chief		23.99
99831 - Surveying Aide		13.65***
99832 - Surveying Technician		17.73
99840 - Vending Machine Attendant		24.31
99841 - Vending Machine Repairer		30.96
99842 - Vending Machine Repairer Helper		24.31

***Workers in this classification may be entitled to a higher minimum wage under Executive Order 14026 (\$16.20 per hour). Please see the Note at the top of the wage determination for more information. Please also note that the minimum wage requirements of Executive Order 14026 are not currently being enforced as to contracts or contract-like instruments entered into with the federal government in connection with seasonal recreational services or seasonal recreational equipment rental for the general public on federal lands.

ALL OCCUPATIONS LISTED ABOVE RECEIVE THE FOLLOWING BENEFITS:

HEALTH & WELFARE: \$4.98 per hour, up to 40 hours per week, or \$199.20 per week or \$863.20 per month

HEALTH & WELFARE EO 13706: \$4.57 per hour, up to 40 hours per week, or \$182.80 per week, or \$792.13 per month*

*This rate is to be used only when compensating employees for performance on an SCA-covered contract also covered by EO 13706, Establishing Paid Sick Leave for Federal Contractors. A contractor may not receive credit toward its SCA obligations for any paid sick leave provided pursuant to EO 13706.

VACATION: 2 weeks paid vacation after 1 year of service with a contractor or successor; and 4 weeks after 3 years. Length of service includes the whole span of continuous service with the present contractor or successor, wherever employed, and with the predecessor contractors in the performance of similar work at the same Federal facility. (Reg. 29 CFR 4.173)

HOLIDAYS: A minimum of eleven paid holidays per year: New Year's Day, Martin Luther King Jr.'s Birthday, Washington's Birthday, Memorial Day, Juneteenth National Independence Day, Independence Day, Labor Day, Columbus Day, Veterans' Day, Thanksgiving Day, and Christmas Day. (A contractor may substitute for any of the named holidays another day off with pay in accordance with a plan communicated to the employees involved.) (See 29 CFR 4.174)

THE OCCUPATIONS WHICH HAVE NUMBERED FOOTNOTES IN PARENTHESES RECEIVE THE FOLLOWING:

1) COMPUTER EMPLOYEES: This wage determination does not apply to any individual employed in a bona fide executive, administrative, or professional capacity, as defined in 29 C.F.R. Part 541. (See 41 C.F.R. 6701(3)). Because most Computer Systems Analysts and Computer Programmers who are paid at least \$27.63 per hour (or at least \$684 per week if paid on a salary or fee basis) likely qualify as exempt computer professionals under 29 U.S.C. 213(a)(1) and 29 U.S.C. 213(a)(17), this wage determination may not include wage rates for all occupations within those job families. In such instances, a conformance will be necessary if there are nonexempt employees in these job families working on the contract.

Job titles vary widely and change quickly in the computer industry, and are not determinative of whether an employee is an exempt computer professional. To be exempt, computer employees who satisfy the compensation requirements must also have a primary duty that consists of:

(1) The application of systems analysis techniques and procedures, including consulting with users, to determine hardware, software or system functional specifications;

(2) The design, development, documentation, analysis, creation, testing or modification of computer systems or programs, including prototypes, based on and related to user or system design specifications;

(3) The design, documentation, testing, creation or modification of computer programs related to machine operating systems; or

(4) A combination of the aforementioned duties, the performance of which requires the same level of skills. (29 C.F.R. 541.400).

Any computer employee who meets the applicable compensation requirements and the above duties test qualifies as an exempt computer professional under both section 13(a)(1) and section 13(a)(17) of the Fair Labor Standards Act. (Field Assistance Bulletin No. 2006-3 (Dec. 14, 2006)). Accordingly, this wage determination will not apply to any exempt computer employee regardless of which of these two exemptions is utilized.

2) AIR TRAFFIC CONTROLLERS AND WEATHER OBSERVERS - NIGHT PAY & SUNDAY PAY: If you work at night as part of a regular tour of duty, you will earn a night differential and receive an additional 10% of basic pay for any hours worked between 6pm and 6am.

If you are a full-time employed (40 hours a week) and Sunday is part of your regularly scheduled workweek, you are paid at your rate of basic pay plus a Sunday premium of 25% of your basic rate for each hour of Sunday work which is not overtime (i.e. occasional work on Sunday outside the normal tour of duty is considered overtime work).

**** HAZARDOUS PAY DIFFERENTIAL ****

An 8 percent differential is applicable to employees employed in a position that represents a high degree of hazard when working with or in close proximity to ordnance, explosives, and incendiary materials. This includes work such as screening, blending, drying, mixing, and pressing of sensitive ordnance, explosives, and pyrotechnic compositions such as lead azide, black powder and photoflash powder.

All dry-house activities involving propellants or explosives. Demilitarization, modification, renovation, demolition, and maintenance operations on sensitive ordnance, explosives and incendiary materials. All operations involving re-grading and cleaning of artillery ranges.

A 4 percent differential is applicable to employees employed in a position that represents a low degree of hazard when working with, or in close proximity to ordnance, (or employees possibly adjacent to) explosives and incendiary materials which involves potential injury such as laceration of hands, face, or arms of the employee engaged in the operation, irritation of the skin, minor burns and the like; minimal damage to immediate or adjacent work area or equipment being used. All operations involving, unloading, storage, and hauling of ordnance, explosive, and incendiary ordnance material other than small arms ammunition. These differentials are only applicable to work that has been specifically designated by the agency for ordnance, explosives, and incendiary material differential pay.

**** UNIFORM ALLOWANCE ****

If employees are required to wear uniforms in the performance of this contract (either by the terms of the Government contract, by the employer, by the state or local law, etc.), the cost of furnishing such uniforms and maintaining (by laundering or dry cleaning) such uniforms is an expense that may not be borne by an employee where such cost reduces the hourly rate below that required by the wage determination. The Department of Labor will accept payment in accordance with the following standards as compliance:

The contractor or subcontractor is required to furnish all employees with an adequate number of uniforms without cost or to reimburse employees for the actual cost of the uniforms. In addition, where uniform cleaning and maintenance is made the responsibility of the employee, all contractors and subcontractors subject to this wage determination shall (in the absence of a bona fide collective bargaining agreement providing for a different amount, or the furnishing of contrary affirmative proof as to the actual cost), reimburse all employees for such cleaning and maintenance at a rate of \$3.35 per week (or \$.67 cents per day). However, in those instances where the uniforms furnished are made of "wash and wear" materials, may be routinely washed and dried with other personal garments, and do not require any special treatment such as dry cleaning, daily washing, or commercial laundering in order to meet the cleanliness or appearance standards set by the terms of the Government contract, by the contractor, by law, or by the nature of the work, there is no requirement that employees be reimbursed for uniform maintenance costs.

**** SERVICE CONTRACT ACT DIRECTORY OF OCCUPATIONS ****

The duties of employees under job titles listed are those described in the "Service Contract Act Directory of Occupations", Fifth Edition (Revision 1), dated September 2015, unless otherwise indicated.

**** REQUEST FOR AUTHORIZATION OF ADDITIONAL CLASSIFICATION AND WAGE RATE, Standard Form 1444 (SF-1444) ****

Conformance Process:

The contracting officer shall require that any class of service employee which is not listed herein and which is to be employed under the contract (i.e., the work to be performed is not performed by any classification listed in the wage determination), be classified by the contractor so as to provide a reasonable relationship (i.e., appropriate level of skill comparison) between such unlisted classifications and the classifications listed in the wage determination (See 29 CFR 4.6(b)(2)(i)). Such conforming procedures shall be initiated by the contractor prior to the performance of contract work by such unlisted class(es) of employees (See 29 CFR 4.6(b)(2)(ii)). The Wage and Hour Division shall make a final determination of conformed classification, wage rate, and/or fringe benefits which shall be paid to all employees performing in the classification from the first day of work on which contract work is performed by them in the classification. Failure to pay such unlisted employees the compensation agreed upon by the interested parties and/or fully determined by the Wage and Hour Division retroactive to the date such class of employees commenced contract work shall be a violation of the Act and this contract. (See 29 CFR 4.6(b)(2)(v)). When multiple wage determinations are included in a contract, a separate SF-1444 should be prepared for each wage determination to which a class(es) is to be conformed.

The process for preparing a conformance request is as follows:

- 1) When preparing the bid, the contractor identifies the need for a conformed occupation(s) and computes a proposed rate(s).
- 2) After contract award, the contractor prepares a written report listing in order the proposed classification title(s), a Federal grade equivalency (FGE) for each proposed classification(s), job description(s), and rationale for proposed wage rate(s), including information regarding the agreement or disagreement of the authorized representative of the employees involved, or where there is no authorized representative, the employees themselves. This report should be submitted to the contracting officer no later than 30 days after such unlisted class(es) of employees performs any contract work.
- 3) The contracting officer reviews the proposed action and promptly submits a report of the action, together with the agency's recommendations and pertinent information including the position of the contractor and the employees, to the U.S. Department of Labor, Wage and Hour Division, for review (See 29 CFR 4.6(b)(2)(ii)).
- 4) Within 30 days of receipt, the Wage and Hour Division approves, modifies, or disapproves the action via transmittal to the agency contracting officer, or notifies the contracting officer that additional time will be required to process the request.
- 5) The contracting officer transmits the Wage and Hour Division's decision to the contractor.
- 6) Each affected employee shall be furnished by the contractor with a written copy of such determination or it shall be posted as a part of the wage determination (See 29 CFR 4.6(b)(2)(iii)).

Information required by the Regulations must be submitted on SF-1444 or bond paper.

When preparing a conformance request, the "Service Contract Act Directory of Occupations" should be used to compare job definitions to ensure that duties requested are not performed by a classification already listed in the wage determination. Remember, it is not the job title, but the required tasks that determine whether a class is included in an established wage determination. Conformances may not be used to artificially split, combine, or subdivide classifications listed in the wage determination (See 29 CFR 4.152(c)(1))."

AFFIDAVIT re CONTINGENT FEES

CITY OF Tamuning)
) ss.
ISLAND OF GUAM)

Jesse Munoz [state name of affiant signing below], being first duly sworn, deposes and says that:

1. The name of the offering company or individual is [state name of company] Morco Equipment LLC

2. As a part of the offering company's bid or proposal, to the best of my knowledge, the offering company has not retained any person or agency on a percentage, commission, or other contingent arrangement to secure this contract. This statement is made pursuant to 2 GAR Division 4 11108(f).

3. As a part of the offering company's bid or proposal, to the best of my knowledge, the offering company has not retained a person to solicit or secure a contract with the government of Guam upon an agreement or understanding for a commission, percentage, brokerage, or contingent fee, except for retention of bona fide employees or bona fide established commercial selling agencies for the purpose of securing business. This statement is made pursuant to 2 GAR Division 4 11108(h)

4. I make these statements on behalf of myself as a representative of the offeror, and on behalf of the offeror's officers, representatives, agents, subcontractors, and employees

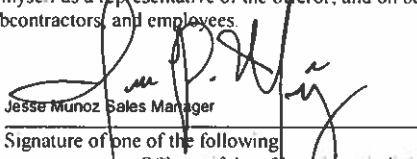
Jesse Munoz Sales Manager

Signature of one of the following

Offeror, if the offeror is an individual,
Partner, if the offeror is a partnership,
Officer, if the offeror is a corporation.

Subscribed and sworn to before me

this 27th day of November, ~~201~~ 2023



NOTARY PUBLIC
My commission expires December 2, 2024

MARY ROSE S. REAL
NOTARY PUBLIC
In and for Guam, U.S.A.
My Commission Expires: **DEC. 02, 2024**
P.O. Box 167 Hagatna, Guam 96932

AG Procurement Form 007 (Jul 15, 2010)

CERTIFICATION OF NON-EMPLOYMENT OF CONVICTED SEXUAL OFFENDERS

Pursuant to Guam Public Law 28-24, as amended by Guam Public Law 28-98, if a contract for services is awarded to an Offeror, then the service provider must warrant that no person in its employment who has been convicted of a sex offense under the provisions of Chapter 25 of Title 9 of the Guam Code Annotated or of an offense defined in Article 2 of Chapter 28 of Title 9 of the Guam Code Annotated, or who has been convicted in any other jurisdiction of an offense with the same elements as heretofore defined, or who is listed on the Sex Offender Registry, shall provide services on behalf of the service provider while on government of Guam property, with the exception of public highways. If any employee of a service provider is providing services on government property and is convicted subsequent to an award of a contract, then the service provider warrants that it will notify the GSWA of the conviction within twenty-four hours of the conviction and will immediately remove such convicted person from providing services on government of Guam property. If the service provider is found to be in violation of any of the provisions of this paragraph, then the GSWA will give notice to the service provider to take corrective action. The service provider shall take corrective action within twenty-four hours of notice from the GSWA, and the service provider shall notify the GSWA when action has been taken. If the service provider fails to take corrective steps within twenty-four hours of notice from the GSWA, then the GSWA in its sole discretion may suspend temporarily any contract for services.

I, Jesse Munoz being a duly authorized representative of the Offeror,
(print name)

acknowledge the requirements described above, have ensured that the Proposal as submitted addresses these requirements, and certify that if awarded the contract, the Offeror will follow these mandates.

Morrco Equipment LLC
(Company Name)

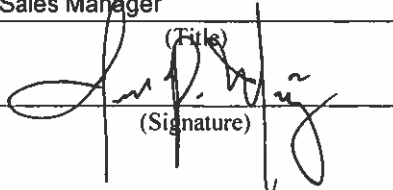
Sales Manager
(Title)

(Signature)

11/27/23
(Date)



GUAM SOLID WASTE AUTHORITY
546 NORTH MARINE CORPS DRIVE TAMUNING, GUAM 96913
TEL: (671) 646-3111 | FAX: (671) 649-3777
WWW.GUAMSOLIDWASTEAUTHORITY.COM

BID BOND

NO. _____

KNOW ALL MEN BY THESE PRESENTS that _____, as Principal Hereinafter called the Principal, and (Bonding Company), _____ A duly admitted insurer under the laws of the Territory of Guam, Surety, hereinafter called the Surety are held firmly bound unto the Territory of Guam for the sum of _____ Dollars (\$ _____), for Payment of which sum will and truly to be made, the said Principal and the said Surety bind ourselves, our heirs, executors, administrators, successors and assigns, jointly and severally, firmly by these presents.

WHEREAS, the Principal has submitted a bid for (identify project by number and brief description)

NOW, THEREFORE, if the Territory of Guam shall accept the bid of the Principal and the Principal shall enter into a contract with the Territory of Guam in accordance with the terms of such bid, and give such bond or bonds as may be specified in bidding or Contract Documents with good and sufficient surety for the faithful performance of such Contract and for the prompt payment of labor and material furnished in the prosecution thereof, or in the event of the failure of the Principal to enter such Contract and give such bond or bonds, if the Principal shall pay to the Territory of Guam the difference not to exceed the penalty hereof between the amounts specified in said bid and such larger amount for which the Territory of Guam may in good faith contract with another part to perform work covered by said bid or an appropriate liquidated amount as specified in the Invitation for Bids then this obligation shall be null and void, otherwise to remain full force and effect.

Signed and sealed this _____ day of _____ 20____

(PRINCIPAL) (SEAL)

(WITNESS)

(TITLE)

(MAJOR OFFICER OF SURETY)

(TITLE)

(MAJOR OFFICER OF SURETY)

(TITLE)

(RESIDENTIAL GENERAL AGENT)

SEE INSTRUCTIONS IN BACK PAGE FOR SUPPORTING DOCUMENTS REQUIRED.

INSTRUCTION TO PROVIDERS:

NOTICE to all Insurance and Bonding Institutions

The Bond requires the signatures of the Vendor, two (2) major Officers of the Surety and Resident General Agent, if the Surety is a foreigner or alien surety.

When the form is submitted to the Guam Solid Waste Authority, it should be accompanied with copies of the following:

1. Current Certificate of Authority to do business on Guam Issued by the Department of Revenue and Taxation.
2. Power Of Attorney issued by the Surety to the Resident General Agent.
3. Power of Attorney issued by two (2) major officers of the Surety to whoever is signing on their behalf.

Bonds, submitted as Bid Guarantee, without signatures and supporting documents are invalid and Bids will be rejected.



GUAM SOLID WASTE AUTHORITY
546 NORTH MARINE CORPS DRIVE TAMUNING, GUAM 96913
TEL: (671) 646-3111 | FAX: (671) 649-3777
WWW.GUAMSOLIDWASTEAUTHORITY.COM

BID BOND

Bond No.: CIC-SUBID23-1041

NO. GSWA-004-24

KNOW ALL MEN BY THESE PRESENTS that Morrico Equipment, LLC, as Principal Hereinafter called the Principal, and (Bonding Company), Century Insurance Company (Guam), Ltd. A duly admitted insurer under the laws of the Territory of Guam, Surety, hereinafter called the Surety are held firmly bound unto the Territory of Guam for the sum of 15% of Bid Amount Dollars (\$ 15% of Bid Amount), for Payment of which sum will and truly to be made, the said Principal and the said Surety bind ourselves, our heirs, executors, administrators, successors and assigns, jointly and severally, firmly by these presents.

WHEREAS, the Principal has submitted a bid for (identify project by number and brief description) GSWA-004-24 Bid for Compact Wheel Loader w/attachments

NOW, THEREFORE, if the Territory of Guam shall accept the bid of the Principal and the Principal shall enter into a contract with the Territory of Guam in accordance with the terms of such bid, and give such bond or bonds as may be specified in bidding or Contract Documents with good and sufficient surety for the faithful performance of such Contract and for the prompt payment of labor and material furnished in the prosecution thereof, or in the event of the failure of the Principal to enter such Contract and give such bond or bonds, if the Principal shall pay to the Territory of Guam the difference not to exceed the penalty hereof between the amounts specified in said bid and such larger amount for which the Territory of Guam may in good faith contract with another part to perform work covered by said bid or an appropriate liquidated amount as specified in the Invitation for Bids then this obligation shall be null and void, otherwise to remain full force and effect

Signed and sealed this 22nd day of November, 2023

Percival DLG Acejo
(WITNESS)

Senior Account Broker - AB RISK SOLUTIONS
(TITLE)

Cornelio L. Montanguihan
(MAJOR OFFICER OF SURETY)

General Manager - Century Insurance Company
(TITLE)

Morrico Equipment, LLC
(PRINCIPAL)

MORRICO EQUIPMENT
Sales, Rental, Parts and Service
197 Ypao Road Tamuning, Guam 96913
Tel: 649-1946 Fax: 649-1947
Website: www.morricequipment.com

Kevin K. Ward
(MAJOR OFFICER OF SURETY)

Vice President and Director - Century Insurance Company
(TITLE)

Assurance Brokers, Inc. dba AB RISK SOLUTIONS
(RESIDENTIAL GENERAL AGENT)

SEE INSTRUCTIONS IN BACK PAGE FOR SUPPORTING DOCUMENTS REQUIRED.

GOVERNMENT OF GUAM

GENERAL TERMS AND CONDITIONS

SEALED BID SOLICITATION AND AWARD

ONLY THOSE BOXES CHECKED BELOW ARE APPLICABLE TO THIS BID

1. **AUTHORITY:**

This solicitation is issued subject to all the provisions of the Guam Procurement Act (5GCA, Chapter 5) and the Guam Procurement Regulations (copies of both are available at the Office of the Comptroller of Laws, Department of Law, copies available for inspection at the Guam Solid Waste Authority). It requires all parties involved in the Preparation, negotiation, performance, or administration of contracts to act in good faith.

2. **GENERAL INTENTION:** Unless otherwise specified, these General Terms and conditions are intended for the bidder to provide the Government of Guam (Government) with specified services or with materials, supplies or equipment completely assembled and ready for use.

3. **TAXES:** Bidders are cautioned that they are subject to Guam Income Taxes as well as all other taxes on Guam transactions. Specific information on taxes may be obtained from the Director of Revenue and Taxation.

4. **LICENSING:** Bidders are cautioned that the Government will not consider for award any offer submitted by a bidder who has not complied with the Guam Licensing law. Specific information on licenses may be obtained from the Director of Revenue and Taxation.

5. **LOCAL PROCUREMENT PREFERENCE:** All procurement of supplies and services where possible, will be made from among businesses licensed to do business on Guam in accordance with section 5008 of the Guam Procurement Act (5GCA, Chapter 5) and Section 1104 of the Guam Procurement Regulations.

6. **COMPLIANCE WITH SPECIFICATIONS AND OTHER SOLICITATION REQUIREMENTS:** Bidders shall comply with all specifications and other requirements of the Solicitation.

7. **"ALL OR NONE" BIDS:** Unless otherwise allowed under this Solicitation, "all or none" bids may be deemed to be non-responsive. If the bid is so limited, the Government may reject part of such proposal and award on the remainder.

NOTE: By checking this item, The Government is requesting all of the bid items to be items to be bid or none at all. **The Government will not award on an itemized basis.** Reference 3-101.06 of the Guam Procurement Regulations.

8. **INDEPENDENT PRICE DETERMINATION:** The bidder, upon signing the Invitation for Bid, certifies that the prices in his bid were derived without collusion, and acknowledges that collusion and anti-competitive practices are prohibited by law. Violations will be subject to the provision of Section 5651 of that of the Guam Procurement Act. Other existing civil, criminal or administrative remedies are not impaired and may be in addition to the remedies in Section 5651 of the Government code. By submitting a bid, the bidder certifies that its price was independently arrived at without collusion.

9. **BIDDER'S PRICE:** The Government will consider not more than two (2) (basic and Alternate) item prices and the bidder shall explain fully each price if supplies, materials, equipment, and/or specified services offered comply with specifications and the products origin. Where basic or alternate bid meets the minimum required specification, cost and other factors will be considered. Failure to explain this requirement will result in rejection of the bid.

10. **BID ENVELOPE:** Envelope shall be sealed and marked with the Bidder's name, Bid number, time, date and place of Bid opening.

11. **BID GUARANTEE REQUIREMENT:** Bidder is required to submit a Bid Guarantee Bond or standby irrevocable Letter of Credit or Certified Check or Cashier's Check in the same bid envelope to be held by the Government pending delivery of items being procured. The Bid Guarantee Bond, Letter of Credit, Certified Check or cashier's check must be issued by any local surety or banking institution licensed to do business on Guam and made payable to the Guam Solid Waste Authority in the amount of fifteen percent (15%) of the total bid offer. The Bid Bond must be submitted on Government Standard Form BB-1 (copy enclosed). Personal Checks will not be accepted as Bid Guarantee. If a successful Bidder (contractor) withdraws from the bid or fails to enter into contract within the prescribed time, such Bid guarantee will be forfeited to the Government of Guam. Bids will be disqualified if not accompanied by Bid Bond, Letter of Credit, Certified Check or Cashier's Check. Bidder must include in his/her bid, valid copies of a Power of Attorney from the Surety and a Certificate of Authority from the Government of Guam to show proof that the surety company named on the bond instrument is authorized by the Government of Guam to be qualified to do business on Guam. For detailed information on bonding matters, contact the Department of Revenue and Taxation. Failure to submit a valid Power of Attorney and Certificate of Authority on the surety is cause for rejection of bid. (GPR Section 3109(c)(3)) Pursuant to 5 GCA Section 5212, all competitive sealed bidding for the procurement of supplies or services exceeding \$25,000 must be accompanied by bid security in the amount of 15% of the total bid price.

12. **PERFORMANCE GUARANTEE:** Bidders, who are awarded a contract under this solicitation, guarantee that goods will be delivered or required services performed within the time specified. Failure to perform the contract in a satisfactory manner may be cause for suspension or debarment from doing business with the Government and for enforcement of Section 23 of these General Terms and Conditions. In addition, the Government will hold the Vendor liable and will enforce the requirements as set forth in Section 41 of these General Terms and Conditions.

13. **SURETY BONDS:** Bid and Performance Bonds coverage must be signed or countersigned in Guam by a foreign or alien surety's resident general agent. The Surety must be an Insurance Company, authorized by the Government of Guam and qualified to do business in Guam. Bids will be disqualified if the Surety Company does not have a valid Certificate of Authority from the Government of Guam to conduct business in Guam.

14. **COMPETENCY OF BIDDERS:** Bids will be considered only from the such bidders who, in the opinion of the Government, can show evidence of their ability, experience, equipment, and facilities to render satisfactory service.

15. **DETERMINATION OF RESPONSIBILITY OF BIDDERS:** The Guam Solid Waste Authority reserves the right for securing from bidders information to determine whether or not they are responsible and to inspect plant site, place of business, and supplies and services as necessary to determine their responsibility in accordance with Section 15 of these General Terms and Conditions (GPR Section 3-401).

16. **STANDARD FOR DETERMINATION OF LOWEST RESPONSIBLE BIDDER:** In determining the lowest responsible offer, the Guam Solid Waste Authority shall be guided by the following:

- a) Price of items offered.
- b) The ability, capacity, and skill of the Bidder to perform.
- c) Whether the bidder can perform promptly within the specified time.
- d) The quality of performance of the Bidder with regards to awards previously made to him.
- e) The previous and existing compliance by the Bidder with laws and regulations relative to procurement.
- f) The sufficiency of the financial resources and ability of the Bidder to perform.
- g) The ability of the bidder to provide future maintenance and services for the subject of the award.
- h) The compliance with all of the conditions to the Solicitation.

17. **TIE BIDS:** If the bids are for the same unit price or total amount in the whole or in part, the Chief Procurement Officer will determine award based on 2 GAR, Div. 4, § 3109(o) (2) or to reject all such bids.

18. **BRAND NAMES:** Any reference in the Solicitation to manufacturer's Brand Names and number is due to lack of a satisfactory specification of commodity description. Such preference is intended to be descriptive, but not restrictive and for the sole purpose of indicating to prospective bidders a description of the article or services that will be satisfactory. Bids on comparable items will be considered provided the bidder clearly states in his bid the exact articles he is offering and how it differs from the original specification.

19. **CONTRACT AWARD:** In accordance with 5 GCA § 5211(g) and 2 GARR § 3109(n), after bids are publicly opened, an award will be made with reasonable promptness by written notice to the lowest responsible and responsive bidder whose bid meets the requirements and criteria set forth in the Invitation for Bids. The award will be made by

- Purchase Order
- Standard Form Contract

20. **DESCRIPTIVE LITERATURE:** Descriptive literature(s) as specified in this solicitation must be furnished as a part of the bid and must be received at the date and time set for the opening Bids. The literature furnished must clearly identify the item(s) in the Bid. The descriptive literature is required to establish for the purpose of evaluation and award details of the product(s) the bidder proposes to furnish including design, materials, components, performance characteristics, methods of manufacture, construction, assembly or other characteristics which are considered appropriate. Rejection of the Bid will be required if the descriptive literature(s) do not show that the product(s) offered conform(s) to the specifications and other requirements of this solicitation. Failure to furnish the descriptive literature(s) by the time specified in the Solicitation will require rejection of the bid.

21. **SAMPLES:** Sample(s) of the item(s) specified in this solicitation must be furnished as a part of the bid and must be received at the date and time set for opening Bids. The sample(s) should represent exactly what the bidder proposes to furnish and will be used to determine if the item(s) offered complies with the specifications. Rejection of the Bid will be required if the sample(s) do not show that the product(s) offered conform(s) to the specifications and other requirements of this solicitation. Failure to furnish the sample(s) by the time specified in the Solicitation will require rejection of the Bid.

22. **LABORATORY TEST:** Successful bidder is required to accompany delivery of his good with a Laboratory Test Report indicating that the product he is furnishing the Government meets with the specifications. This report is on the bidder's account and must be from a certified Testing Association.

23. **AWARD, CANCELLATION, & REJECTION:** Award shall be made to the lowest responsible bidder, whose bid is determined to be the most advantageous to the Government, taking into consideration the evaluation factors set forth in this solicitation. No other factors or criteria shall be used in the evaluation. The right is reserved as the interest of the Government may require to waive any minor irregularity in bid received. The Guam Solid Waste Authority shall have the authority to award, cancel, or reject bids, in whole or in part for any one or more items if he determines it is in the public interest. In case of an error in the extension of prices, unit price will govern. It is the policy of the Government to award contracts to qualified local bidders. The Government reserves the right to increase or decrease the quantity of the items for award and make additional awards for the same type of items and the vendor agrees to such modifications and additional awards based on the bid prices for a period of thirty (30) days after original award. No award shall be made under this solicitation which shall require advance payment or irrevocable letter of credit from the government (GPR Section 3-202.14.1)

24. **MARKING:** Each outside container shall be marked with the Purchase Order number, item number, brief item description and quantity. Letter marking shall not be less than ¾" in height.

25. **SCHEDULE FOR DELIVERY:** Successful bidder shall notify the Guam Solid Waste Authority, Telephone No. 647-4312 at least twenty-four (24) hours before delivery of any item under this solicitation.

26. **BILL OF SALE:** Successful supplier shall render Bills of Sale for each item delivered under this contract. Failure to comply with this requirement will result in rejection of delivery. The Bill of Sale must accompany the items delivered but will not be considered as an invoice for payment. Supplier shall bill the Government in accordance with billing instructions as indicated on the Purchase Order.

27. **MANUFACTURER'S CERTIFICATE:** Successful bidder is required, upon delivery of any item under this solicitation, to furnish a certificate from the manufacturer indicating that the goods meet the specifications. Failure to comply with this request will result in rejection of delivery or payment. Supplier shall bill the Government in accordance with billing instructions as indicated on the Purchase Order.

28. **INSPECTION:** All supplies, materials, equipment, or services delivered under this contract shall be subject to the inspection and/or test conducted by the Government at destination. If in any case the supplies, materials, equipment, or services are found to be

defective in material, workmanship, performance, or otherwise do not conform with the specifications, the Government shall have the right to reject the items or require that they be corrected. The number of days required for correction will be determined by the Government.

29. **MOTOR VEHICLE SAFETY REQUIREMENTS:** The Government will only consider Bids on motor vehicles which comply with the requirements of the National Traffic and Motor Vehicle safety Act of 1966 (Public Law 89-563) and Clean Air Act as amended (Public Law 88-206), that are applicable to Guam. Bidders shall state if the equipment offered comply with these aforementioned Federal Laws.

30. **SAFETY INSPECTIONS:** All motor vehicles delivered under this contract must pass the Government of Guam Vehicle Inspection before delivery at destination.

31. **GUARANTEE:**

a) **Guarantee of Vehicle Type of Equipment**

The successful bidder shall guarantee vehicular type of equipment offered against defective parts, workmanship, and performance, for a period of not less than one (1) year after date of receipt of equipment. Bidder shall also provide service to the equipment for at least one (1) year. Service to be provided shall include, but will not be limited to tune ups (change of spark plugs, contact points and condensers) and lubrication (change of engine and transmission oil). All parts and labor shall be at the expense of the bidder. All parts found defective and not caused by misuse, negligence or accident within the guarantee period shall be repaired, replaced, or adjusted within six (6) working days after notice from the Government and without cost to the Government. Vehicular type of equipment as used in this context shall include equipment used for transportation as differentiated from tractors, backhoes, etc.

b) **Guarantee of Other Type of Equipment:**

The successful bidder shall guarantee all other types of equipment offered, except those mentioned in 31a, above, against defective parts, workmanship, and performance for a period of not less than three (3) months after date of receipt of equipment. Bidder shall also provide service to the equipment for at least three (3) months. All parts found within that period shall be repaired or replaced by the Contractor without cost to the Government. Repairs, adjustments or replacements of defective parts shall be completed by the contractor within six (6) working days after notice from the Government.

(c) **Compliance with this Section is a condition of this Bid.**

32. **REPRESENTATION REGARDING ETHICS IN PUBLIC PROCUREMENT:** The bidder or contractor represents that it has not knowingly influenced and promises that will not knowingly influence a Government employee to breach any of the ethical standards and represents that it has not violated, is not violating, and promises that it will not violate the prohibition against gratuities and kickbacks set forth on Chapter 11 (Ethics in Public Contracting) of the Guam Procurement Act and in Chapter 11 of the Guam Procurement Regulations.

33. **REPRESENTATION REGARDING CONTINGENT FEES:** The contractor represents that it has not retained a person to solicit or secure a Government contract upon and agreement or understanding for a commission, percentage, brokerage, or contingent fee, except for retention of bona fide employees of bona fide established commercial selling agencies for the purpose of securing business (GPR Section 11-207).

34. **EQUAL EMPLOYMENT OPPORTUNITY:** Contractors shall not discriminate against any employee or applicant of employment because of race, color, religion, sex, or national origin. The contractor will take affirmative action to ensure that employees are treated equally during employment without regards to their race, color, religion, sex, or national origin.

35. **COMPLIANCE WITH LAWS:** Bidders awarded a contract under this Solicitation shall comply with the applicable standard, provisions, and stipulations of all pertinent Federal and/or local laws, rules, and regulations relative to the performance of this contract and the furnishing of goods.

36. **CHANGE ORDER:** Any order issued relative to awards made under this solicitation will be subject to and in accordance with the provisions of Section 6-101-03.1 of the Guam Procurement Regulations.

37. **STOP WORK ORDER:** Any stop work order issued relative to awards made under this solicitation will be subject to and in accordance with the provisions of Section 6-101-04.1 of the Guam Procurement Regulations.

38. **CANCELLATION OF INVITATION FOR BIDS OR REQUEST FOR PROPOSALS:** Any Invitation for Bid may be cancelled, or any or all bids or proposals may be rejected in whole or in part as may be specified in the solicitation, when it is in the best interests of the Territory in accordance with regulations promulgated by the Policy Office. The reasons therefor shall be made part of the contract file.

39. **TIME FOR COMPLETION:** It is hereby understood and mutually agreed by and between the contractor and the Government that the time for delivery to final destination or the timely performance of certain services is an essential condition of this contract. If the contractor refuses or fails to perform any of the provisions of this contract within the time specified in the Purchase Order (from the date Purchase Order is acknowledged by the vendor), then the contractor is in default. Defaults will be treated subject to and in accordance with the provisions of Section 6-101-08 of the Guam Procurement Regulations.

40. **JUSTIFICATION OF DELAY:** Bidders who are awarded contracts under this Solicitation, guarantee that the goods will be delivered to their destination or required services rendered within the time specified. If the bidder is not able to meet the specified delivery date, he is required to notify the Guam Solid Waste Authority of such delay. Notification shall be in writing and shall be received by the Guam Solid Waste Authority at least twenty-four (24) hours before the specified delivery date. Notification of delay shall include an explanation of the causes and reasons for the delay including statement(s) from supplier or shipping company causing the delay. The Government reserves the right to reject delay justification if, in the opinion of the Chief Procurement Officer, such justification is not adequate.

41. **SERVICE-DISABLED VETERAN OWNED BUSINESS PREFERENCE:** Bidding is subject to the policy in favor of Service-Disabled Veteran Owned Business as defined in 5 GCA sections 5011 and 5012.

42. **LIQUIDATED DAMAGES:** When the contractor is given notice of delay or nonperformance as specified in Paragraph 1 (Default) of the Termination for Default Clause of this contract and fails to cure in the time specified, the contractor shall be liable for

damages for delay in the amount of one-fourth of one percent (1%) of outstanding order per calendar day from date set for cure until either the territory reasonable obtains similar supplies or services if the contractor is terminated for default, or until the contractor provides the supplies or services if the contractor is not terminated for default. To the extent that the contractor's delay or non-performance is excused under Paragraph 15 (Excuse for Nonperformance or Delayed Performance) of the Termination for Default Clause of this contract, liquidated damages shall not be due the territory. The contractor remains liable for damages caused other than by delay. 2 GAR, Div. 4 §6101(d).

[x] 43. **PHYSICAL LIABILITY:** If it becomes necessary for the Vendor, either as principal, agent or employee, to enter upon the premises or property of the Government of Guam in order to construct, erect, inspect, make delivery or remove property hereunder, the Vendor hereby covenants and agrees to take, use, provide and make all proper, necessary and sufficient precautions, safeguards and protections against occurrence of any accidents, injuries or damages to any person or property during the progress of the work herein covered, and to be responsible for, and to indemnify and save harmless the Government of Guam from the payment of all sums of money by reason of all or any such accidents, injuries, or damages that may occur upon or about such work, and fines, penalties and loss incurred for or by reasons of the violations of any territorial ordinance, regulations, or the laws of Guam or the United States, while the work is in progress. Contractor will carry insurance to indemnify the Government of Guam against any claim for loss, damage or injury to property or persons arising out of the performance of the Contractor or its employees and agents of the services covered by the contract and the use, misuse or failure of any equipment used by the contractor or his employees or agents, and shall provide certificates of such insurance to the Government of Guam when required.

[x] 44. Contract will be cancelled if funds not appropriated or insufficient, and that government will timely inform contractor. 2 GAR, Div.4 §3121(e) (1) (C) and 2 GAR, Div. 4 §3121 (e)(1)(D).

[x] 45. **CONTACT FOR CONTRACT ADMINISTRATION:** If your firm receives a contract as a result of this Solicitation, Please designate a person whom we may contact for prompt administration.

Name: Jesse Munoz

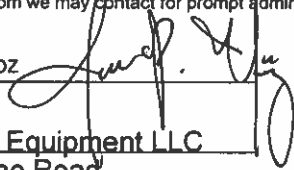

Title: Sales Manager

Address: Morricon Equipment LLC
197 Ypao Road,
Tamuning, Guam 96913

Telephone: (671)649-1946

GOVERNMENT OF GUAM

SEALED BID SOLICITATION INSTRUCTIONS

1. **BID FORMS:** Each bidder shall be provided with two (2) sets of Solicitation forms. Additional copies may be provided upon request. Bidders requesting additional copies of said forms will be charged per page in accordance with Section 6114 of the Government Code of Guam. All payments for this purpose shall be by cash, certified check or money order and shall be made payable to the Guam Solid Waste Authority.
2. **PREPARATIONS OF BIDS:**
 - a. Bidders are required to examine the drawings, specifications, schedule, and all instructions. Failure to do so will be at bidder's risk.
 - b. Each bidder shall furnish the information required by the Solicitation. The bidder shall sign the solicitation and print or type his name on the Schedule. Erasures or other changes must be initialed by the person signing the bid. Bids signed by an agent are to be accompanied by evidence of this authority unless such evidence has been previously furnished to the issuing office.
 - c. Unit price for each unit offered shall be shown and such price shall include packing unless otherwise specified. A total shall be entered in the amount column of the Schedule for each item offered. In case of discrepancies between a unit price and extended price, the unit price will be presumed to be correct.
 - d. Bids for supplies or services other than those specified will not be considered. Time, if stated as a number of days, means calendar days and will include Saturdays, Sundays, and holidays beginning the day after the issuance of a Notice to Proceed. Time stated ending on Saturday, Sunday or Government of Guam legal holiday will end at the close of the next business day.
 - e. No Entitlement to Preparation Costs – the bidder expressly waives any right it may have against the government for any expenses incurred in connection with the preparation of its bid.
3. **EXPLANATION TO BIDDERS:** Any explanation desired by a bidder regarding the meaning or interpretation of the Solicitation, drawings, specifications, etc., must be submitted in writing and with sufficient time allowed for a written reply to reach all bidders before the submission of their bids. Oral explanations or instructions given before the award of the contract will not be binding. Any information given to a prospective bidder concerning a Solicitation will be furnished to all prospective bidders in writing as an amendment to the Solicitation if such information would be prejudicial to uninformed bidders.
4. **ACKNOWLEDGEMENT OF AMENDMENTS TO SOLICITATIONS:** Receipt of an amendment to a Solicitation by a bidder must be acknowledged by signing an acknowledgement of receipt of the amendment. Such acknowledgement must be received prior to the hour and date specified for receipt of bids.
5. **SUBMISSION OF BIDS:**
 - a. Bids and modifications thereof shall be enclosed in sealed envelopes and addressed to the office specified in the Solicitation. The bidder shall show the hour and date specified in the Solicitation for receipt, the Solicitation number, and the name and address of the bidder on the face of the envelope.
 - b. Electronic bids will not be considered unless authorized by the Solicitation. However, bids may be modified or withdrawn by written or electronic notice, provided such notice is received prior to the hour and date specified for receipt (see paragraph 6 of these instructions).
 - c. Samples of items, when required, must be submitted within the time specified, unless otherwise specified by the Government, at no expense to the Government. If not destroyed by testing, samples will be returned at bidder's request and expense, unless otherwise specified by the Solicitation.
 - d. Samples or descriptive literature should not be submitted unless it is required by this solicitation. Regardless of any attempt by a bidder to condition the bid, unsolicited samples or descriptive literature will not be examined or tested at the bidder's risk, and will not be deemed to vary any of the provisions of this Solicitation.
6. **FAILURE TO SUBMIT BID:** If no bid is to be submitted, do not return the solicitation documents unless otherwise specified. A letter or postcard shall be sent to the issuing office advising whether future Solicitations for the type of supplies or services covered by this Solicitation are desired.
7. **LATE BID, LATE WITHDRAWALS, AND LATE MODIFICATIONS:**
 - a. Definition: Any bid received after the time and date set for receipt of bids is late. Any withdrawal or modification of a bid received after the time and date set for opening of bids at the place designated for opening is late (Guam Procurement Regulations Section 3-202)
 - b. Treatment: No late bid, late modification, or late withdrawal will be considered unless received before contract award, and the bid, modification, or withdrawal would have been timely but for the action or inaction of territorial personnel directly serving the procurement activity.
9. **GOVERNMENT FURNISHED PROPERTY:** No material, labor or facilities will be furnished by the Government unless otherwise provided for in the Solicitation.
10. **CANCELLATION OR REVISION OF BID:** This IFB may be canceled, or any and all bids may be rejected in whole or in part as may be pursuant to GAR § 3115, when it is in the best interest of the Government. Additionally, in accordance with GAR § 9105, if prior to award it is determined that a solicitation or proposed award of a contract is in violation of the law, then the solicitation or proposed award shall be canceled or revised to comply with the law. The reasons therefore shall be made part of the contract file.
11. **REJECTION OF BIDS:** Any bidder submitted in response to this IFB may be rejected in whole or in part with it is in the best interest of the Government, in accordance with GAR § 3115(e). Reasons for rejecting bids include but are not limited to: (1) The business that submitted the bid is non-responsive as determined under GAR § 3116; (2) The bid ultimately fails to meet the announced requirements of the Government in some material respect; or (3) The bid price is clearly unreasonable. Upon request, successful bidders shall be advised of the reasons for rejection.

When bids are rejected, or a solicitation canceled after bids are received, the bids which have been opened shall be retained in the procurement file, or if unopened, returned to the bidders upon request, or otherwise disposed of pursuant to GAR § 3115(g).

- 12. TERMINATION OF CONTRACT: 1. TERMINATION OF CONVENIENCE PURSUANT TO GAR § 6101(10)**
- (a) **Termination:** The Government, when the interest of the Government so requires, may terminate this contract in whole or in part, for the Convenience of the Government. The Purchasing Agency shall give written notice of the termination to the contractor specifying the part of the contract terminated when termination becomes effective.
 - (b) **Contractor's Obligations:** The contractor shall incur no further obligations in connection with the terminated work and on the date set in the notice of termination the contractor will stop work to the extent specified.
 - (c) **Condition of Termination:** Notwithstanding the foregoing, the cessation of services for people requiring services shall be contingent upon the Government obtaining a substitute provider for the services and the contractor shall cooperate by taking all reasonable and necessary steps to ensure that services are not interrupted and transferred to the succeeding provider. The contractor shall issue a written memorandum detailing the status of the contractor's ongoing services initiating termination or any fault of either party.
- 13. SELLER'S INVOICES:** Invoices shall be prepared and submitted in quadruplicate (one copy shall be marked "original") unless otherwise specified. Invoices shall be "certified true and correct" and shall contain the following information: Contract and order number (if any), item numbers, description of supplies or services, sizes, quantities, unit prices, and extended total. Bill of lading number and weight of shipment will be shown for shipments made on Government bills of lading.
- 14. RECEIPT, OPENING AND RECORDING OF BIDS:** Bids and modifications shall be publicly opened in the presence of one or more witnesses, at the time, date, and place designated in the Invitation for Bids. The name of each bidder, the bid price, and such other information as is deemed appropriate by the Procurement Officer, shall be read aloud and recorded, or otherwise made available. The names and addresses of required witnesses shall be recorded at the opening. The opened bids shall be available for public inspection except to the extent the bidder designates trade secrets or other proprietary data to be confidential as set forth in accordance with Section 12, below. Material so designated shall accompany the bid and shall be readily separable from the bid in order to facilitate public inspection of the non-confidential portion of the bid. Prices, makes and models or catalogue numbers of the items offered, deliveries, and terms of payment shall be publicly available at the time of bid opening regardless of any designation to the contrary (Guam Procurement Regulations Section 3-202.12.2).
- 15. CONFIDENTIAL DATA:** The Procurement Officer shall examine the bids to determine the validity of any requests for nondisclosure of trade secrets and other proprietary data.
- 16. PROHIBITION AGAINST GRATUITIES AND KICKBACKS:** With respect to this procurement and any other contract that bidder may have or wish to enter into with the Government, the bidder represents that he/she has not violated, is not violating, and promises that he will not violate the prohibition against gratuities and kickbacks set forth in the Guam Procurement Regulations – GAR § 11170(e)
- 17. STATEMENT OF QUALIFICATIONS** The ability capacity and skill of the Bidders to perform; Whether the bidder can perform promptly or within the specified time; The quality of performance of the Bidder with regards to awards previously made to him; The sufficiency of the financial resources and ability of the bidders to perform; And the compliance with all of the conditions to the solicitation.
- 18. WAGE AND BENEFIT COMPLIANCE-CONTRACTORS PROVIDING SERVICES:**
- (a) Contractor with regard to all person its employs whose purpose in whole or in part is the direct delivery of services contracted for with the Government of Guam in this procurement, shall pay such employees in accordance with the Wage Determination for Guam and the Northern Marianas Islands issued and promulgated by the U.S. Department of Labor for such labor as is employed in the direct deliverance of deliverables to the government of Guam. 5 GCA § 5801 Contractor shall be responsible for flowing down this obligation to its subcontractors.
 - (b) The Wage Determination most recently issued by the U.S. Department of Labor at the time this Agreement was awarded to Contractor shall be used to determine wages and benefits which shall be paid to employees pursuant to this clause. 5 GCA § 5801
 - (c) Should any contract contain a renewal clause, then at the time of renewal adjustments there shall be stipulations contained in that contract for applying the Wage Determination, so that the Wage Determination promulgated by the U.S. Department of Labor on a date most recent to the renewal date shall apply. 5 GCA § 5801
 - (d) In addition to the Wage Determination detailed above, health and similar benefits for employees having a minimum value as detailed in the wage Determination issued and promulgated by the U.S. Department of labor shall apply. Contractor shall pay a minimum of ten (10) paid holidays per annum per employee. 5 GCA § 5802
 - (e) Any violation of Contractor or its subcontractors obligations of this section shall be investigated by the Guam Department of Labor and may include a monetary penalty assessment by the Guam Department of Labor of no less that One Hundred Dollars (\$100.00) per day, and no more than One Thousand Dollars (\$1,000.00) per day, until such time as a violation has been corrected, as well as the payment of all back wages and benefits due. 5 GCA § 5803
 - (f) In addition to any and all other breach of contract actions the Government of Guam may have under this procurement, in the event there is a violation in the process set forth in subsection (e) above, Contractor may be placed on probationary status by the Chief Procurement Officer of the General Service Agency, or its successor, for a period of one (1) year.
During the probationary status, a Contractor shall not be awarded any contract by any instrumentality of the Government of Guam. A Contractor who has been on probationary status, or has been assessed a monetary

penalty pursuant to 5 GCA Article 13 Title 5 may appeal such penalty of probationary status to the Superior Court of Guam. 5 GCA § 5804

- (g) Contractor along with all proposed offerors and submitter under this procurement were required to submit a Declaration of Compliance with Wage Determination laws as part of this procurement with a copy of the most recent Wage Determination for Guam and the Northern Marianas Islands issued and promulgated by the U.S. Department of Labor. 5 GCA § 5805
 - (h) The applicable USDOL Wage Determination Rate Revision (as defined by subsections (b) and (c) is to this Agreement. Contractor agrees to provide upon written request by the Government of Guam written certification of its compliance with its obligations as part of each invoice, along with the names of any employees, their positions, and detailed wage and benefits paid in keeping with this section. Additionally upon request by Government of Guam the Contractor shall submit source documents as to those individuals provide direct services in part or whole under this Agreement and its payments to them of such wages and benefits.
19. **ETHICAL STANDARDS:** With respect to this procurement and any other contract that the Contractor may have, or wish to enter into, with any Government of Guam agency, the Contractor represents that it has not knowingly influenced, and promises that it will not knowingly influence, any government employee to breach any of the ethical standards set forth in the Guam Procurement Law and in any of the Guam Procurement Regulations. – GAR § 11103 (b).
20. **PROHIBITION AGAINST CONTINGENT FEES:** The Contractor represents that he has not retained any person or agency upon an Agreement or Understanding for a percentage, commission, brokerage, or other contingent arrangement, except for retention of bona fide employees or bona fide established commercial selling agencies, to solicit or secure this Agreement or any contract with the government of Guam or its agencies. GAR § 11108(f)
21. **CONTRACTOR'S WARRANTY AS TO EMPLOYEES AND SEX OFFENSES. Reference 5 GCA 5253(b):** : Contractor warrants that no person providing services on behalf of the Contractor has been convicted of a sex offense under the provisions of Chapter 25 of Title 9 of GCA or an offense as defined in Article 2 of Chapter 28, Title 9 GCA, or an offense in another jurisdiction with, at a minimum, the same elements as such offenses, or who is listed on the Sex Offender Registry.
- Contractor warrants that if any person providing services on behalf of Contractor is convicted of a sex offense under the provisions of Chapter 25 of Title 9 GCA, or an offense as defined in Article 2 of Chapter 28, Title 9 GCA, or an offense in another jurisdiction with, at a minimum, the same elements as such offenses, or who is listed on the Sex Offender Registry, that such person will be immediately removed from working at said agency and that the administrator of said agency be informed of such within twenty-four (24) hours of such conviction. Any contractor found in violation of this section, after notice from the Government of Guam, after notice from the contracting authority of such violation, shall within twenty-four (24) hours, take corrective action and shall report such action to the contracting authority. Failure to take corrective action with the stipulated period may result in the temporary suspension of the contract at the discretion of the Government of Guam.
22. **POLICY IN FAVOR OF SERVICE-DISABLED VETERAN OWNED BUSINESSES:** P.L. 31-115 (September 20, 2011) 5 GCA § 5011 and § 5012 In the procurement of any supply or service, (except for professional services), if such supply or service is offered by a Service Disabled Veteran Owned Business "SDVOB", as defined in 5 GCA § 5012, that is at least fifty one percent (51%) owned by service-disabled veteran(s), and if the supply or service is available within the period that is required for the procurement, and the price for the supply or service does not exceed one hundred five percent (105%) of the lowest bidder price, a preference shall be given to that SDVOB by the Government of Guam, and the supply or service shall be purchased from said SDVOB. This shall be in addition to any other procurement benefit the SDVOB may qualify for under Guam law. A business concern is a qualified SDVOB if: (a) the business concern is licensed to do business on Guam; (b) the business concern maintains its headquarters on Guam; (c) the business concern is at least fifty-one (51%) owned by a service-disabled veteran(s) who served in the active U.S. military service, was discharged or released under honorable conditions and whose disability is service-connected as demonstrated by a DD214, and certified by an award letter from the U.S. Department of Veterans Affairs; the DD214 and Disability award letter from U.S. Department of Veterans Affairs are submitted to the Government of Guam procuring agency for every service offered; and the service disabled veteran(s) owner(s) of the business concern has filed individual tax returns on Guam for a period of at least three (3) consecutive years.
23. **CERTIFICATION OF INDEPENDENT PRICE DETERMINATION:** The undersigned Bidder certifies that the bid price submitted was Independently arrived at without collusion — GAR § 3126
24. **LICENSING OR CERTIFICATE(S) OF EXEMPTIONS:** Bidders are cautioned that the Government will not consider for award any offer submitted by a bidder who cannot comply with the Guam Licensing Law. Specific information on license or exemptions may be obtained from the Director of Revenue and Taxation.
25. **EQUAL EMPLOYMENT OPPORTUNITY:** Bidder shall not discriminate against any employee or applicant for employment because of race, color, religion, sex, or national origin. The contractor will take affirmative action to ensure that employees are treated equally during employment without regards to their race, color, religion, sex, or national origin.
26. **DISCLOSURES OF MAJOR SHAREHOLDERS:** (5 GCA § 5233) As a condition of submitted a bid, any partnership, sole proprietorship or corporation doing business with the Government of Guam shall submit an affidavit executed under oath that lists the name and address of any person who has held more than ten percent (10%) of the outstanding interest or shares in said month period immediately preceding submission of proposal.



GUAM SOLID WASTE AUTHORITY



LOURDES A. LEON GUERRERO
Governor of Guam

JOSHUA F. TENORIO
Lt. Governor of Guam

IRVIN L. SLIKE
General Manager

November 27, 2023

INVITATION FOR BID GSWA-004-24 COMPACT WHEEL LOADER W/ ATTACHMENTS

AMENDMENT NO. 3

1. Amend page 31 of 34

From:

Bid Due Date & Bid Opening at the Guam Solid Waste
Authority: Administration Office, GSWA Bldg., 2nd Fl.
546 N. Marine Corps Dr., Tamuning, Guam

Tuesday, November 28, 2023
at 1:00PM
Chamorro Standard Time

To Now Read:

Bid Due Date & Bid Opening at the Guam Solid Waste
Authority: Administration Office, GSWA Bldg., 2nd Fl.
546 N. Marine Corps Dr., Tamuning, Guam

Tuesday, December 5, 2023
at 1:00PM
Chamorro Standard Time

*All others remain the same.

Irvin L. Slike,
General Manager

ACKNOWLEDGEMENT RECEIPT

Return to GSWA by email or fax.

Received By: Paul Eustaquio
Date: 11/27/23
Company Name: Morrico Equipment

Fax to: 671-649-3777

Email: procurement@gswa.guam.gov



GUAM SOLID WASTE AUTHORITY

LOURDES A. LEON GUERRERO
Governor of Guam

JOSHUA F. TENORIO
Lt. Governor of Guam

IRVIN L. SLIKE
General Manager



ITEM NO.	DESCRIPTION	QTY	UOM	UNIT PRICE	PRICE EXTENSION
1.0	Compact Wheel Loader w/ Attachments	1	EA	\$ 180,557.00	\$ 180,557.00

SPECIFICATIONS:

Indicate on each line of the technical specifications whether or not each item complies with the specification or an exception is being taken. If additional space is required to fully explain bid exceptions, attach additional typed page(s) to the bid submittal indicating the section number and subsection that has the exception, and provide explanation.

	COMPLY / NON-COMPLIANCE
Engine: Gross HP at 2400 RPM: 73 HP minimum	Comply
Peak Torque at 1560 RPM: 206 foot lbs. minimum	Comply
Emissions: Compliant with EPA Final Tier 4/EU Stage V	Comply
Four cylinders	Comply
Powertrain: Hydrostatic with infinitely variable speed control over full range of operating speeds. 2 speed ranges, joystick mounted F-N-R, acceleration pedal.	Comply
Axles: Fixed, 100% differential, manually engaged front axle, fixed conventional differential rear axle or oscillating rear axle	Comply
Max rise and fall single wheel: 15 inches maximum, 14 inch minimum	Please see attached letter of deviation
Hydraulically activated, self-adjusting internal wet disc brakes and driveline drum brake	Comply
Cooling: Hydraulically driven, proportionally controlled fan or belt-driven fan	Please see attached letter of deviation
Articulation Angle: 30 degrees each direction	Comply
Cylinders: Heat treated chrome plated polished cylinder rods, hardened steel, replaceable bushings and pivot pins	Comply
Hydraulics: Main pump (loader and steering): 18 GPM standard, 29 GPM with high flow option.	Comply
Quick Coupling: Conforms with ISO 16028 quick coupling for all attachments	Comply
Electrical: Voltage: 12-volt or 24-volt electrical system	Comply
Battery: One (1) 24-volt or two (2) 12-volt	Comply
Battery capacity: One (1) 925 CCA or Two (2) 900 CCA	Comply
Cab: Seat: Air ride high back with head rest and dual lumbar support or mechanical suspension seat	Comply
Noise: Operator ear 70 dBA, Bystander 101 dBA	



GUAM SOLID WASTE AUTHORITY

LOURDES A. LEON GUERRERO
Governor of Guam

JOSHUA F. TENORIO
Governor of Guam

IRVIN L. SLIKE
General Manager



	<u>COMPLY / NON-COMPLIANCE</u>
Air conditioning	Comply
Steering: Dual tilt and telescoping steering column	Comply
Performance: Conforms with SAE J1040, SAE J231, ISO 3471 and ISO 3449 ROPS/FOPS	Comply
Operating Weight: ISO quick coupler and 1CY general purpose bucket / bolt on edge 12,250 lbs. minimum	Comply
1.4 CY multi-purpose bucket: 12,800 lbs. maximum	Please see attached Letter of Deviation
Wheelbase: 7 feet minimum	Comply
Dump clearance: 40-degree full height – 8 feet 3 inches	Comply
Reach: 40-degree full height – 32 inches	Comply
Fork height fully raised: 10 feet minimum	Comply
Fork tipping load straight: 7000 lb. maximum	Comply
Attachments: ISO quick coupling mechanism: Conforms with ISO 16028	Comply
One (1) additional 1.4 CY bucket with bolt on edge	Please see attached Letter of Deviation
One (1) Tink claw bucket model 520 or equal	Comply
One (1) 60-inch pick-up broom: 800 lb. minimum; 900 lb. max	Please see attached Letter of Deviation
One (1) Fork: 48 inches minimum	Comply
Equipment Warranty: The Bidder guarantees to the Purchaser that the equipment, upon delivery, will be brand new and will have been constructed using entirely new components. Furthermore, the Bidder assures that any new equipment provided shall be free from any defects in manufacturing workmanship and materials for a duration of 24 months or 2,000 hours, whichever occurs first, commencing from the date of equipment delivery. This warranty encompasses any necessary repairs or replacements without any additional cost to the Purchaser.	Comply
Miscellaneous Items: One (1) operator's manual hardcopy	Comply
One (1) operator's manual on CD	Please see attached Letter of Deviation
One (1) complete illustrated parts book	Comply
One (1) shop repair manual	Comply
One (1) warranty manual	Please see attached Letter of Deviation
Manufacturer's training of GSWA crew (8 hours) & contracted mechanics (20 hours)	Comply
Online manual for parts, service & repair	Please see attached Letter of Deviation



GUAM SOLID WASTE AUTHORITY



LOURDES A. LEON GUERPELO
Governor of Guam

JOSHUA F. TENORIO
Lieutenant Governor

IRVIN L. SLIKE
General Manager

Delivered with a full tank of fuel

Comply

Note: The GSA Federal Contract will be considered along with its terms and conditions if offered.

Bidding On:

Manufacturer:

Case / Paladin / Werk Brau / Tink Inc.

Year:

2024

Model:

221F / QB961L / WBLH92125 / C520 / 21560

Place of Origin:

United States of America

Date of Delivery:

200 Days



ADDRESS: 197 Ypao Road, Tamuning
Guam 96913
OFFICE: Phone: 1-671-649-1946
FAX: 1-671-649-1947
SPARE PARTS: Phone: 1-671-646-7914
Fax: 1-671-646-7900
WEB: www.morricoequipment.com



To : Irvin Slike
General Manager
Guam Solid Waste Authority
546 North Marine Corps Drive
Tamuning, Guam 96913

Email : Procurement@gswa.guam.gov
From : Paul Eustaquio / Ross Morrison

Date : December 5, 2023
Pages : 1 of 2

RE : Equipment Proposal "New" Case 221F Compact Loader with Attachments

Dear Sir,
We provide the following proposal and attached specifications for your review and consideration.

Compact Loader "New"

- Make: Case
- Year: 2024
- Model: 221F
- Engine: 74 Hp, Diesel Liquid-Cooled US Emission Certified Tier 4 Final
- Transmission: 4WD Hydrostatic Transmission
- Bucket: 82 Inch @ 1 CU Yd3 with Bolt on Cutting Edge
- Operating Weight: 12,547 lbs.
- Tire Size: 365/80 R18 (Front and Back)
- Wheel Base: 87.6 Inches
- Dump Clearance: 8 Foot 3 Inches
- Enclosed Cabin with Air Conditioner
- Standard Lights
- SSL Quick Coupler
- Back up Alarm
- Operators Manual
- Case Manufacturer Warranty 24 Months / 2000 Hours

Attachments Included

- 1) Werk Brau 1.38 CY Multipurpose Bucket
- 2) Werk Brau 1.25 CY General Purpose Bucket
- 3) Case Bucket Broom Sweeper for Case Wheel Loader 221F
- 4) 520 Tink Claw Bucket
- 5) Case Fork Attachment with 48 Inch Tines

ON-SITE DIESEL DELIVERY





ADDRESS: 197 Ypao Road, Tamuning
Guam 96913
OFFICE: Phone: 1-671-649-1946
FAX: 1-671-649-1947
SPARE PARTS: Phone: 1-671-646-7914
Fax: 1-671-646-7900
WEB: www.morricequipment.com



RE : Equipment Proposal "New" Case 221F Compact Loader with Attachments

Estimated Delivery:

"200-Days" As per bid specifications
Subject to Factory Confirmation
Subject to Shipping Schedules

Terms of Payment:

As Per Government Purchase Order

Quotation Is Valid For 120 Days

Full Parts and After Sale Service Available at Morrico Equipment, LLC. Factory Authorized Case New Holland Construction Equipment Dealer and Service Agents.

Please do not hesitate to contact us directly with any questions or concerns you may have. We can be reached at 649-1946 or via email at paul@morricequipment.com

Looking forward to discussing this with you directly.

Regards,

Paul Eustaquio

Heavy Equipment Sales
Morrico Equipment LLC
paul@morricequipment.com
Cell (671) 483-0180

ON-SITE DIESEL DELIVERY





Sales, Rental, Parts and Service

ADDRESS: 197 Ypao Road, Tamuning
Guam 96913
OFFICE: Phone: 1-671-649-1946
FAX: 1-671-649-1947
SPARE PARTS: Phone: 1-671-646-7914
Fax: 1-671-646-7900
WEB: www.morricoequipment.com



LETTER OF DEVIATION

To : Irvin Slike
General Manager
Guam Solid Waste Authority
546 North Marine Corps Drive
Tamuning, Guam 96913

Email : Procurement@gswa.guam.gov
From : Paul Eustaquio / Ross Morrison

Date : December 5, 2023
Pages : 1 of 2

Re: Guam Solid Waste Authority Invitation for Bid GSWA-004-24 Compact Wheel Loader with Attachment

Dear Sir,

1. Max rise and fall single wheel: 15 Inch Maximum, 14 Inch Minimum

Deviation #1. Our Manufacturer Case has a Rise and fall single wheel of 11.8 Inches for their Case 221F Loader.

2. Hydraulically driven, proportionally controlled fan or belt-driven fan

Deviation #2. Our Manufacturer Case supplies a fan directly connected to the engine for their Case 221F Loader.

3. 1.4 CY multipurpose bucket; 12,800 lbs. maximum

Deviation #3. Our manufacturer Werk Brau supply a 1.38 CY Multipurpose Bucket. This is the closest size to a 1.4 CY Multipurpose Bucket that can be supplied.

4. One(1)additional 1.4 CY bucket with bolt on cutting edge

Deviation #4. Our manufacturer Werk Brau supply a 1.25 CY General Purpose Bucket. This is the closest size to a 1.4 CY General Purpose Bucket that can be supplied.

ON-SITE DIESEL DELIVERY





ADDRESS: 197 Ypao Road, Tamuning
Guam 96913
OFFICE: Phone: 1-671-649-1946
FAX: 1-671-649-1947
SPARE PARTS: Phone: 1-671-646-7914
Fax: 1-671-646-7900
WEB: www.morricequipment.com



Re: Guam Solid Waste Authority Invitation for Bid GSWA-004-24 Compact Wheel Loader with Attachment

5. One (1) 60-Inch pick up broom: 800 lbs. minimum; 900 lbs. max

Deviation #5. Our manufacturer Paladin Attachments's smallest pick up sweeper that can be supplied has a weight of 946 lbs.

6. One (1) Operator's manual on CD

Deviation #6. Morrico will supply a copy of the Operators Manual on a USB Drive.

7. One (1) Warranty Manual

Deviation #7. Our Manufacturer Case does not provide a warranty manual.

8. Online manual for parts, service, and repair

Deviation # 8. This is a dealer only item, only dealers are permitted to access the dealer portals. A digital copy of the parts, service, and repair manual will be supplied.

ON-SITE DIESEL DELIVERY





GUAM SOLID WASTE AUTHORITY



LOURDES A. LEON GUERRERO
Governor of Guam

JOSHUA F. TENORIO
Lt. Governor of Guam

IRVIN L. SLIKE
General Manager

November 20, 2023

**INVITATION FOR BID
GSWA-004-24
COMPACT WHEEL LOADER W/ ATTACHMENTS**

AMENDMENT NO. 2

1. Amend page 31 of 34

From:

Deadline for Receipt of Written Questions must be e-mailed to the Guam Solid Waste Authority at procurement@gswa.guam.gov , ATTN: General Manager	Wednesday, November 15, 2023 on or before 5:00PM Chamorro Standard Time
--	---

To Now Read:

Deadline for Receipt of Written Questions must be e-mailed to the Guam Solid Waste Authority at procurement@gswa.guam.gov , ATTN: General Manager	Tuesday, November 21, 2023 on or before 5:00PM Chamorro Standard Time
--	---

2. Amend page 31 of 34

From:

Bid Due Date & Bid Opening at the Guam Solid Waste Authority: Administration Office, GSWA Bldg., 2 nd Fl. 546 N. Marine Corps Dr., Tamuning, Guam	Wednesday, November 22, 2023 at 1:00PM Chamorro Standard Time
--	---

To Now Read:

Bid Due Date & Bid Opening at the Guam Solid Waste Authority: Administration Office, GSWA Bldg., 2 nd Fl. 546 N. Marine Corps Dr., Tamuning, Guam	Tuesday, November 28, 2023 at 1:00PM Chamorro Standard Time
--	---

3. Amend to replace pages 32 of 34 through 34 of 34 with the "Revised 11/20/2023 Page 32" through "Revised 11/20/2023 Page 34" attached.

*All others remain the same.

Irvin L. Slike,
General Manager

ACKNOWLEDGEMENT RECEIPT	
Return to GSWA by email or fax.	
Received by:	<u>Paul Eustaquis</u>
Date:	<u>11/22/23</u>
Company Name:	<u>Norcisco Equipment</u>
Fax to: 671 649 3777	
Email: procurement@gswa.guam.gov	



GUAM SOLID WASTE AUTHORITY



LOURDES A. LEON GUERRERO
Governor of Guam

JOSHUA F. TENORIO
Lt. Governor of Guam

IRVIN L. SLIKE
General Manager

ITEM NO.	DESCRIPTION	QTY	UOM	UNIT PRICE	PRICE EXTENSION
1.0	Compact Wheel Loader w/ Attachments	1	EA	\$ _____	\$ _____

SPECIFICATIONS:

Indicate on each line of the technical specifications whether or not each item complies with the specification or an exception is being taken. If additional space is required to fully explain bid exceptions, attach additional typed page(s) to the bid submittal indicating the section number and subsection that has the exception, and provide explanation.

COMPLY / NON-COMPLIANCE

Engine:

Gross HP at 2400 RPM: 73 HP minimum

Peak Torque at 1560 RPM: 206 foot lbs. minimum

Emissions: Compliant with EPA Final Tier 4/EU Stage V

Four cylinders

Powertrain:

Hydrostatic with infinitely variable speed control over full range of operating speeds. 2 speed ranges, joystick mounted F-N-R, acceleration pedal.

Axles: Fixed, 100% differential, manually engaged front axle, fixed conventional differential rear axle

Max rise and fall single wheel: 15 inches maximum, 14 inch minimum

Hydraulically activated, self-adjusting internal wet disc brakes and driveline drum brake

Cooling:

Hydraulically driven, proportionally controlled fan

Articulation Angle: 30 degrees each direction

Cylinders: Heat treated chrome plated polished cylinder rods, hardened steel, replaceable bushings and pivot pins

Hydraulics:

Main pump (loader and steering): 18 GPM standard, 29 GPM with high flow option.

Quick Coupling: Conforms with ISO 16028 quick coupling for all attachments

Electrical:

Voltage: 12-volt

One (1) battery

Battery capacity: 925 CCA

Cab:

Seat: Air ride high back with head rest and dual lumbar support

Noise: Operator ear 70 dBA, Bystander 101 dBA



GUAM SOLID WASTE AUTHORITY

LOURDES A. LEON GUERRERO
Governor of Guam

JOSHUA F. TENORIO
Lt. Governor of Guam

IRVIN L. SLIKE
General Manager



COMPLY / NON-COMPLIANCE

Air conditioning

Steering: Dual tilt and telescoping steering column

Performance: Conforms with SAE J1040, SAE J231, ISO 3471 and ISO 3449 ROPS/FOPS

Operating Weight:

ISO quick coupler and 1CY general purpose bucket / bolt on edge 12,250 lbs. minimum

1.4 CY bucket: 12,800 lbs. maximum

Wheelbase: 7 feet minimum

Dump clearance: 40-degree full height – 8 feet 3 inches

Reach: 40-degree full height – 32 inches

Fork height fully raised: 10 feet minimum

Fork tipping load straight: 7000 lb. maximum

Attachments:

ISO quick coupling mechanism: Conforms with ISO 16028

One (1) 1.4 CY bucket with bold on edge

One (1) Tink claw bucket model 720 or equal

One (1) 60-inch pick-up broom: 800 lb. minimum; 900 lb. max

One (1) Fork: 48 inches minimum

Equipment Warranty:

The Bidder guarantees to the Purchaser that the equipment, upon delivery, will be brand new and will have been constructed using entirely new components. Furthermore, the Bidder assures that any new equipment provided shall be free from any defects in manufacturing workmanship and materials for a duration of 24 months or 2,000 hours, whichever occurs first, commencing from the date of equipment delivery. This warranty encompasses any necessary repairs or replacements without any additional cost to the Purchaser.

Miscellaneous Items:

One (1) operator's manual hardcopy

One (1) operator's manual on CD

One (1) complete illustrated parts book

One (1) shop repair manual

One (1) warranty manual

Manufacturer's training of GSWA crew (8 hours) & contracted mechanics (20 hours)

Online manual for parts, service & repair



GUAM SOLID WASTE AUTHORITY



LOURDES A. LEON GUERRERO
Governor of Guam

JOSHUA F. TENORIO
Lt. Governor of Guam

IRVIN L. SLIKE
General Manager

Delivered with a full tank of fuel _____

Note: The GSA Federal Contract will be considered along with its terms and conditions if offered.

Bidding On:

Manufacturer: _____

Year: _____

Model: _____

Place of Origin: _____

Date of Delivery: _____



GUAM SOLID WASTE AUTHORITY



LOURDES A. LEON GUERRERO
Governor of Guam

JOSHUA F. TENORIO
Governor of Guam

IRVIN L. SLIKE
General Manager

November 14, 2023

INVITATION FOR BID GSWA-004-24 COMPACT WHEEL LOADER W/ ATTACHMENTS

AMENDMENT NO. 1

1. Amend page 31 of 34

From:

Deadline for Receipt of Written Questions must be e-mailed to the Guam Solid Waste Authority at procurement@gswa.guam.gov, ATTN: General Manager

Thursday, November 9, 2023
on or before 5:00PM
Chamorro Standard Time

To Now Read:

Deadline for Receipt of Written Questions must be e-mailed to the Guam Solid Waste Authority at procurement@gswa.guam.gov, ATTN: General Manager

Wednesday, November 15, 2023
on or before 5:00PM
Chamorro Standard Time

2. Amend page 31 of 34

From:

Bid Due Date & Bid Opening at the Guam Solid Waste Authority: Administration Office, GSWA Bldg., 2nd Fl. 546 N. Marine Corps Dr., Tamuning, Guam

Monday, November 20, 2023
at 1:00PM
Chamorro Standard Time

To Now Read:

Bid Due Date & Bid Opening at the Guam Solid Waste Authority: Administration Office, GSWA Bldg., 2nd Fl. 546 N. Marine Corps Dr., Tamuning, Guam

Wednesday, November 22, 2023
at 1:00PM
Chamorro Standard Time

*All others remain the same.

Irvin L. Slike,
General Manager

ACKNOWLEDGEMENT RECEIPT	
Return to GSWA by email or fax	
Received By	Paul Eustaquio
Date	11/15/23
Company Name	Morris Equipment
Fax to: 671 649 3777	
Email: procurement@gswa.guam.gov	



Sales, Rental, Parts and Service

ADDRESS: 197 Ypao Road, Tamuning
Guam 96913
OFFICE: Phone: 1-671-649-1946
FAX: 1-671-649-1947
SPARE PARTS: Phone: 1-671-646-7914
Fax: 1-671-646-7900
WEB: www.morricoequipment.com



November 15, 2023

MORRICO EQUIPMENT QUESTIONS

Irvin Slike
General Manager
Guam Solid Waste Authority
546 North Marine Corps Drive
Tamuning, Guam 96913

Re: Guam Solid Waste Authority Invitation for Bid GSWA-004-24 Compact Wheel Loader with Attachment

Dear Sir,
Morrico Equipment LLC submits the below questions in regards to Invitation for Bid No. GSWA-004-24 Compact Wheel Loader with Attachments Bid.

Specifications

1. Axles: Fixed, 100% differential, manually engaged front axle, fixed conventional differential rear axle.

Question # 1. Is an oscillating rear axle acceptable?

2. Max rise and fall single wheel: 15 inches maximum, 14 inch minimum.

Question # 2. Please clarify what is required by the term listed above.

3. Hydraulically Driven, proportionally controlled fan.

Question # 3. Will a belt driven fan be acceptable?

4. Voltage: 12 Volt

Question # 4. Will a 24 Volt Electrical System be Acceptable?

5. One (1) Battery

Question # 5. Will two 12 Volt Batteries be acceptable?

Page 1 of 2

ON-SITE DIESEL DELIVERY





Sales, Rental, Parts and Service

ADDRESS: 197 Ypao Road, Tamuning
Guam 96913
OFFICE: Phone: 1-671-649-1946
FAX: 1-671-649-1947
SPARE PARTS: Phone: 1-671-646-7914
Fax: 1-671-646-7900
WEB: www.morricequipment.com



Re: Guam Solid Waste Authority Invitation for Bid GSWA-004-24 Compact Wheel Loader with Attachment

6. Battery Capacity: 925 CCA

Question # 6. Will two Batteries with 900 CCA be acceptable?

7. Seat: Air Ride high back with head rest and dual lumbar support

Question # 7. Will a mechanical suspension seat be acceptable?

8. 1.4 CY Bucket: 12,800 lbs. Maximum

Question # 8. Please confirm if this bucket request is for a multipurpose bucket.

9. One (1) 1.4 CY Bucket with Bolt on Cutting Edge

Question # 9. Please confirm if this bucket request is for a Multipurpose Bucket.
Please confirm if this is bucket request is additional to Question 8 bucket request or the same request.

Regards,

Paul Fustaquio
Heavy Equipment Sales
Morrice Equipment LLC
paul@morriceequipment.com
Cell: (671) 483-0180

ON-SITE DIESEL DELIVERY





GUAM SOLID WASTE AUTHORITY

LOURDES A. LEÓN GUERRERO
Governor of Guam

JOSHUA F. TENORIO
Lt. Governor of Guam

IRVIN L. SLIKE
General Manager



November 13, 2023

INVITATION FOR BID GSWA-004-24 COMPACT WHEEL LOADER W/ ATTACHMENTS

Questions and Concerns received from Far East Equipment Co. On November 9, 2023

1. In the specs under Powertrain, the spec reads "Max rise and fall single wheel: 15 inch maximum, 14 inch minimum." Will 10 inches be acceptable?

Response: No, specs remain the same.

2. In the specs under Cooling, the spec reads "Hydraulically driven, proportionally controlled fan." Will direct driven be acceptable?

Response: No, specs remain the same.

3. In the specs under Hydraulics, the spec reads "Main pump (loader and steering): 18 GPM standard, 29 GPM with high flow option." Will a max rated flow 21.13 GPM @ 1,000 PSI be acceptable?

Response: No, specs remain the same.

4. In the specs under Hydraulics, the spec reads "Main pump (loader and steering): 18 GPM standard, 29 GPM with high flow option." Can you clarify why there is a request for high flow option when the requested documents do not require high flow hydraulics?

Response: The pick-up broom specified requires the flow specified.

5. In the specs under Electrical, the spec reads "Battery capacity: 925 CCA." Will 830 CCA be acceptable?

Response: No, specs remain the same.

Irvin L. Slike,
General Manager

ACKNOWLEDGEMENT RECEIPT	
Return to GSWA by email or fax.	
Received By	Paul Eustaquio
Date	11/15/23
Company Name	Morrillo Equipment
Fax to: 671-649-3777	
Email: procurement@gswa.guam.gov	



GUAM SOLID WASTE AUTHORITY

LOURDES A. LEON GUERRERO
Governor of Guam

JOSHUA F. TENORIO
1st. Governor of Guam

IRVIN L. SLIKE
General Manager



November 14, 2023

INVITATION FOR BID GSWA-004-24 COMPACT WHEEL LOADER W/ ATTACHMENTS

Questions and Concerns received from Far East Equipment Co. On November 13, 2023

1. In regards to the high-flow hydraulics requirement for the broom attachment, John Deere's broom attachment does "NOT" require high-flow. Will high-flow still be required?

Response: The hydraulic flow range is typical for brooms.

2. What make and model machine was used to form the specs of this bid?

Response: John Deere model 244P.

Irvin L. Slike,
General Manager

ACKNOWLEDGEMENT RECEIPT

Return to GSWA by email or fax

Received By Paul Eustaquio
Date: 11/15/23
Company Name Morrice Equipment

Fax to: 671-649-3777

Email: procurement@gswa.guam.gov



GUAM SOLID WASTE AUTHORITY

LOURDES A. LEON GUERRERO
Governor of Guam

JOSHUA F. TENORIO
Lt. Governor of Guam

IRVIN L. SLIKE
General Manager



November 20, 2023

INVITATION FOR BID GSWA-004-24 COMPACT WHEEL LOADER W/ ATTACHMENTS

Questions and Concerns received from Morrico Equipment on November 15, 2023

1. Axles: Fixed, 100% differential, manually engaged front axle, fixed conventional differential rear axle. Is an oscillating rear axle acceptable?

Response: Yes, refer to Amendment No. 2.

2. Max rise and fall single wheel: 15 inches maximum, 14 inches minimum. Please clarify what is required by the term listed above.

Response: The term "Max rise and fall single wheel: 15 inches maximum, 14 inches minimum" pertains to the vertical movement capability of a single wheel on the compact wheel loader. Here's a breakdown of the requirement:

- **Max Rise:** This refers to the maximum vertical distance the center of a single wheel is allowed to move upward from its resting position. In this context, the specified maximum rise is 15 inches.
- **Min Fall:** Conversely, the minimum fall denotes the minimum vertical distance the center of a single wheel is permitted to move downward from its resting position. For this specification, the minimum fall is 14 inches.

These parameters are crucial for ensuring that the compact wheel loader can effectively navigate varied terrains, accommodate different load sizes, and maintain stability during operation.

3. Hydraulically Driven, proportionally controlled fan. Will a belt driven fan be acceptable?

Response: Yes, refer to Amendment No. 2.

4. Voltage: 12-volt. Will a 24 Volt Electrical System be acceptable?

Response: Yes, refer to Amendment No. 2.

5. One (1) Battery. Will two 12-volt batteries be acceptable?

Response: Yes, refer to Amendment No. 2.

6. Battery Capacity: 925 CCA. Will two batteries with 900 CCA be acceptable?

Response: Yes, refer to Amendment No. 2.



GUAM SOLID WASTE AUTHORITY

LOURDES A. LEON GUERRERO
Governor of Guam

JOSHUA F. TENORIO
Governor of Guam

IRVIN L. SLIKE
General Manager



7. Seat: Air Ride high back with head rest and dual lumbar support. Will a mechanical suspension seat be acceptable?

Response: Yes, refer to Amendment No. 2.

8. 1.4 CY Bucket: 12,800 lbs. Maximum. Please confirm if this bucket request is for a multipurpose bucket.

Response: Refer to Amendment No. 2.

9. One (1) 1.4 CY Bucket with Bolt on Cutting Edge. Please confirm if this bucket request is for a Multipurpose Bucket. Please confirm if this is bucket request is additional to Question 8 bucket request or the same request.

Response: Refer to Amendment No. 2.

Questions and Concerns received from Far East Equipment Co. on November 17, 2023

10. The manufacturer of the Tink Claw bucket does not recommend the C720 (2.7CYD) model for this size machine. They recommend the C520 (1.2CYD) model for a machine of this size. With this information, does GSWA want to proceed with a C720 model bucket though it may pose a tipping hazard?

Response: No, refer to Amendment No. 2.

Irvin L. Slike,
General Manager

ACKNOWLEDGEMENT RECEIPT	
Return to GSWA by email or fax.	
Received By	Paul Eustaquio
Date:	11/22/23
Company Name	Morrizo Equipment
Fax to: 671 649 3777	
Email: procurement@gswa.guam.gov	



GUAM SOLID WASTE AUTHORITY

LOURDES A. LEON GUERRERO
Governor of Guam

JOSHUA F. TEMORIO
Lt. Governor of Guam

IRVIN L. SLIKE
General Manager



IFB TIMETABLE:

The following IFB timetable should be used as a working guide for planning purposes. GSWA reserves the right to adjust this timetable as required during the course of the IFB process.

Registration Form for GSWA IFB Packet will be available on the Guam Solid Waste Authority website at www.gswa.guam.gov .	Friday, November 3, 2023
---	--------------------------

Deadline for Receipt of Written Questions must be e-mailed to the Guam Solid Waste Authority at procurement@gswa.guam.gov . ATTN: General Manager	Thursday, November 9, 2023 on or before 5:00PM Chamorro Standard Time
--	---

Deadline for Answers to Written Questions will be e-mailed to Offerors who registered.	Wednesday, November 14, 2023 on or before 5:00PM Chamorro Standard Time
--	---

Bid Due Date & Bid Opening at the Guam Solid Waste Authority: Administration Office, GSWA Bldg., 2 nd Floor, 546 N. Marine Corps Dr., Tamuning, Guam	Monday, November 20, 2023 at 1:00PM Chamorro Standard Time
---	--

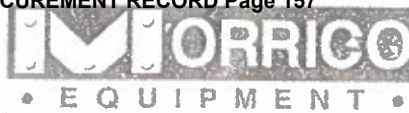

Sales, Rental, Parts and Service
197 Ypao Road, Tamuning, Guam 96913
www.morricequipment.com
Tel: 671-649-1946

221F

COMPACT WHEEL LOADER
TIER 4 FINAL CERTIFIED

CASE

CONSTRUCTION



ENGINE

Model	FPT F5H FL463 A
Emissions Certification	Tier 4 Final
Type	4-stroke
Cylinders	4
Bore/Stroke	3.9 x 4.3 in (99 x 110 mm)
Displacement	207 in ³ (3.4 L)
Fuel injection	High pressure, common rail injection
Fuel	Diesel
Fuel filter	Spin on, Beta (4) = 20
Air filter	Dry type element w/ warning restriction indicator
Exhaust aftertreatment:	Cooled Exhaust Gas Recirculation (CEGR) w/ Diesel Oxidation Catalyst (DOC)
Radiator:	
Core type	All aluminum
Fan:	
Style	Direct drive
Lubrication/cooling oil pump:	
Stvie	Integral
Engine oil:	
Pump:	Rotor Pump w/ deep sump pan, plate cooled & pressurized under piston nozzles
Pump operating angle ratings:	
Side-to-side	Rated 35°
Fore and aft	Rated 35°
Oil filtration	Spin on, full flow
Engine speeds	RPM
Rated - full load	2500
Low idle	950
High idle - no load	2500
Horsepower @ 2500 RPM:	
Gross	74 hp (55 kW)
Net	70 hp (52 kW)
Peak torque @ 1400 RPM:	
Gross	232 lb-ft (314 N-m)
Net	227 lb ft (308 N-m)

NOTE: Gross horsepower and torque per SAE J1349
Net horsepower and torque per SAE J1349

DRIVETRAIN

Transmission	Hydrostatic transmission	
Pump relief	6,092 psi (42 000 kPa)	
Pump flow @ 2500 RPM	37.0 gpm (140 L/min)	
Differential:	Open standard/limited slip or 100% lock opt.	
Front axles:		
Differential ratio	3.67	
Planetary ratio	6.00	
Final axle ratio	22.00	
Gear box:		
1st ratio	2.46	
Gear box HS:		
1st ratio	2.75	
2nd ratio	1.16	
Planeteraries	Outboard	
Service brakes:	Master cylinder hydraulically actuated, wet disc on front axle	
Parking brake:	Mechanical, caliper on front axle	
Travel speeds	Forward	Reverse
	mph (kph)	mph (kph)
1st Low	3.3 (5.3)	3.3 (5.3)
2nd High	11.4 (18.3)	11.4 (18.3)
Travel speeds - HS	Forward	Reverse
	mph (kph)	mph (kph)
1st Low	3.0 (4.8)	3.0 (4.8)
2nd High	8.1 (13.0)	8.1 (13.0)
3rd High	18.6 (30.0)	18.6 (30.0)

NOTE: Travel speeds at full engine throttle
w/ 365/80 R18 tires

ELECTRICAL

Voltage	12 Volts
Alternator	120 amp
Batteries	95 AHR, 900 CCA

OPERATOR ENVIRONMENT

ROPS: ISO 3471; 2,008 lb (6 800 kg); Base and Deluxe Cab w/ heater and A/C; Key start; Articulated power steering w/ tilt column; Full adjustable, cloth suspension seat; Foot throttle; Single joystick w/ electronic speed shift control F/N/R switch and proportional loader control; Cup holder; Retractable seat belt; Storage tray on Deluxe Cab; Sun screen - front; Opening side window; Dome light; Wipers - front and rear; 12-volt auxiliary power; Lighter cigar and ashtray; Pocket cellular phone; Coat hook; External rearview mirrors; Loader control lockout.

Electronic information center

Displays/Gauges:
Vehicle speed; Hourmeter; Floating functionality on; High flow functionality on; Clock; Vehicle directions; Gear number engaged; PM Catalyst icons.

Indicator lights:

Diff. lock; Main hydraulic enabled; Turn light - left and right; Rear work lamps; Work lamps; Main high beam; Side lights; Stop; Warning signal; Rabbit; Hand brake; Brake fluid level. Quick coupler on; Ride Control on; Creep speed; PM Catalyst; Low fuel level; Clogging air filter; Engine oil pressure; Glow plug; Alternator changing.

Audible alarms:

Caution alarm; Critical alarm, Backup alarm.

Horn

NOTE: If equipped w/ option.

OPERATING WEIGHT

Z-Bar:

Unit equipped w/ ROPS/FOPS cab w/ heater, standard counterweight, 365/70 R18 Dunlop Tires, front and rear fenders, 1.2 vd³ (0.9 m³) general purpose bucket w/ edge, full fuel, 165 lb (75 kg) operator:
12,547 lb (5 691 kg)

HYDRAULICS

Pump - steering/implement:

Open-centered pressure/flow compensated

Fixed gear type:

Standard flow:

Max. 22.5 gpm @ 3,336 psi
(Max. 85 L/min @ 230 bar)

Optional high flow:

Max. 34.3 gpm @ 2,901 psi
(Max. 130 L/min @ 230 bar)

Loader control valve:

Open-center, Hydraulic Loader Control w/ single lever includes: Forward/Neutral/Reverse switch, Floating switch, Low/High Travel mode switch, Auxiliary Function Roller

Loader auxiliary steering

Hydraulic orbital center-pivot articulating w/ on-demand oil flow

Main relief pressure 3,336 psi (23 000 kPa)

Filtration:

15-micron, full flow replaceable cartridges on return line

SERVICE CAPACITIES

Fuel tank	22.7 gal (86.0 L)
Hydraulic system:	
Reservoir	10.6 gal (40.0 L)
Total	14.0 gal (53.0 L)
Front and rear axle:	
Front axle	2.3 gal (8.7 L)
Rear axle	2.6 gal (10.0 L)
Rear axle HS	2.5 gal (9.45 L)
Engine oil w/ filter	1.8 gal (7.0 L)
Cooling*	3.4 gal (13.0 L)

NOTE: *1.72 gal (6.5 L) antifreeze + 1.72 gal (6.5 L) water.

OTHER SPECIFICATIONS

Lift cylinders	Two (2)
Bore diameter	3.25 in (82.5 mm)
Rod diameter	1.97 in (50.0 mm)
Stroke	29.57 in (751.0 mm)
Tilt cylinder:	
Bore diameter	3.49 in (88.7 mm)
Rod diameter	2.25 in (57.1 mm)
Stroke	19.96 in (507.0 mm)

Loader:
 Z-Bar:
 Z-Bar loader linkage
 Single control for lift and tilt
 Positive hold float
 Hydraulic attachment coupler:
 Skid steer compatible/horizontal pin compatible

Cycle time:
 Z-Bar:

Raise w/ rated bucket load	5.8 sec
Dump w/ rated bucket load	1.7 sec
Lower - empty	3.8 sec

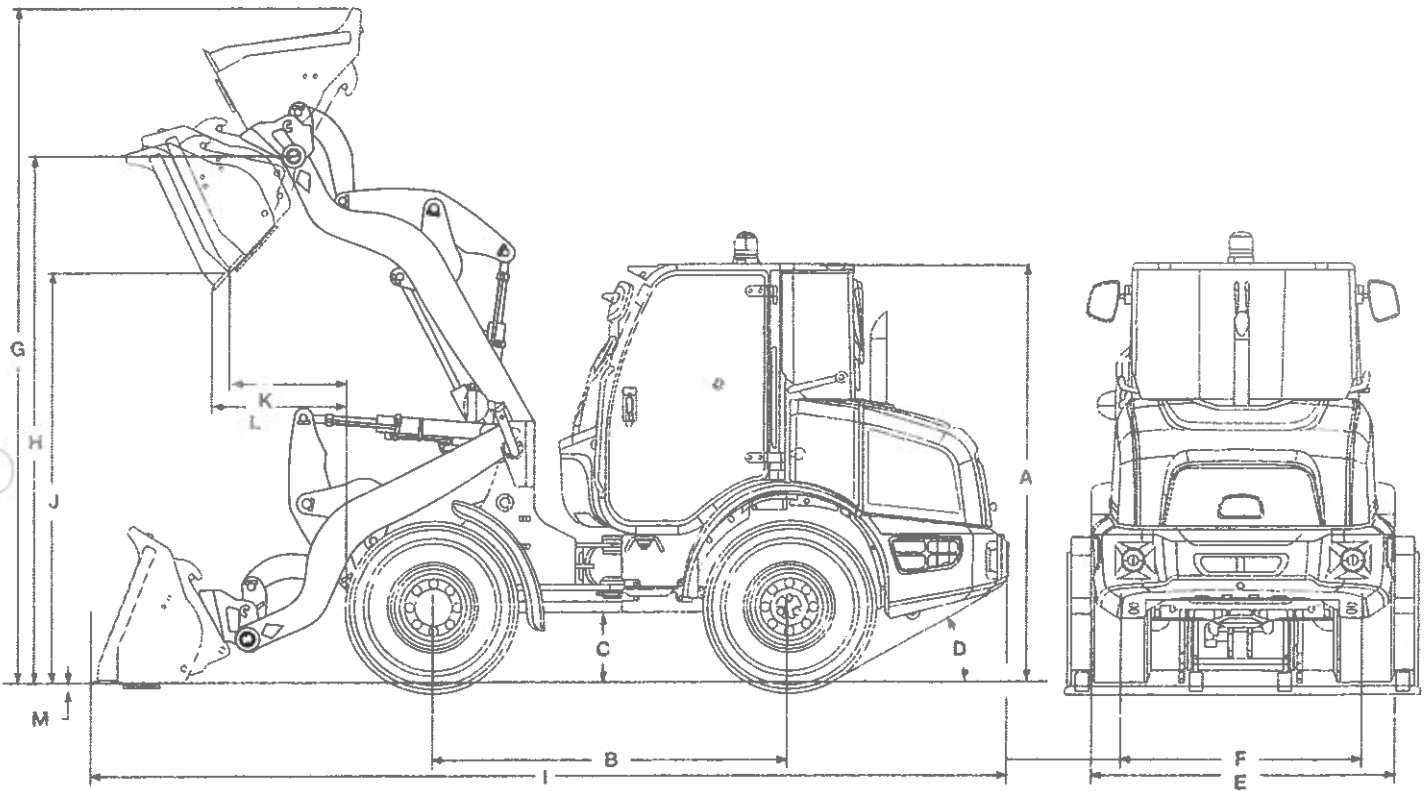

Line drawings are for illustrative purpose only and may not be exact representation of unit.

DIMENSIONS

A. Height to top of ROPS cab	103.4 in (2 627 mm)
B. Wheelbase	87.6 in (2 225 mm)
C. Ground clearance under shaft	17.3 in (440 mm)
Ground clearance under axles	12.5 in (317 mm)
D. Angle of departure	27°
Width:	
E. Overall without bucket	73.2 in (1 860 mm)
F. Centerline tread	59.1 in (1 500 mm)
Turning radius - outside	157.0 in (3 987 mm)
Turning angle:	
From center	40°
Total angle	80°
Rear axle oscillation - total	20°



Sales, Rental, Parts and Service
 197 Ypao Road, Tamuning, Guam 96913
 www.morricequipment.com
 Tel: 671 640 4045

PERFORMANCE SPECS

221F Z-Bar

	1.2 yd ³ GP (0.9 m ³) GP Bucket with Bolt-on Edge	1.56 yd ³ GP (1.2 m ³) LM Bucket with Bolt-on Edge
ISO bucket capacity – struck	0.92 yd ³ (0.7 m ³)	1.31 yd ³ (1.0 m ³)
Heaped	1.18 yd ³ (0.9 m ³)	1.57 yd ³ (1.2 m ³)
Bucket width – outside	80.7 in (2 050 mm)	82.7 in (2 100 mm)
Bucket weight – includes coupler and added components	1,060 lb (481 kg)	1,160 lb (526 kg)
G. Operating height – fully raised with spillguard	170.4 in (4 327 mm)	176.0 in (4 470 mm)
H. Hinge pin height – fully raised	129.5 in (3 290 mm)	129.5 in (3 289 mm)
I. Overall length – bucket level on ground	231.1 in (5 869 mm)	234.8 in (5 964 mm)
Dump angle – fully raised	48°	48°
J. Dump height – fully raised, 45° dump	95.5 in (2 425 mm)	92.8 in (2 358 mm)
K. Bucket reach – fully raised, 45° dump	40.2 in (1 020 mm)	42.8 in (1 087 mm)
L. Bucket reach – 7 ft 0 in (2.13 m) height, 45° dump	51.5 in (1 309 mm)	51.9 in (1 318 mm)
M. Dig depth	3.9 in (98 mm)	3.9 in (98 mm)
Operating Load (ROC) - ISO	4,007 lb (1 818 kg)	3,984 lb (1 807 kg)
Maximum material density – ISO	3,404 lb/yd ³ (2 020 kg/m ³)	2,538 lb/yd ³ (1 506 kg/m ³)
Tipping load – ISO:		
Straight	9,318 lb (4 227 kg)	9,287 lb (4 212 kg)
40° turn	8,014 lb (3 635 kg)	7,968 lb (3 614 kg)
Lift capacity:		
Full height	8,317 lb (3 773 kg)	8,217 lb (3 727 kg)
Maximum reach	10,597 lb (4 807 kg)	10,497 lb (4 761 kg)
Ground	12,975 lb (5 886 kg)	12,796 lb (5 804 kg)
Breakout force with tilt cylinder	10,959 lb (4 971 kg)	9,109 lb (4 132 kg)
Maximum rollback:		
@ Ground	40°	40°
@ Carry position	46°	46°
@ Maximum reach	62°	62°
@ Full height	62°	62°
Maximum grading angle with bucket – back dragging	58°	60°
Loader clearance circle with bucket	368.9 in (9 371 mm)	373.4 in (9 484 mm)

FORKS

221F Z-Bar

Fork length	47.2 in (1 200 mm)
Fork weight – includes coupler	880 lb (399 kg)
Operating load – level ground	5,002 lb (2 269 kg)
Operating mass	12,364 lb (5 608 kg)
Tipping load – straight	6,898 lb (3 129 kg)
Tipping load – 40° turn	6,252 lb (2 836 kg)
Fork load center	19.7 in (500 mm)

MORRICO
EQUIPMENT
 Sales, Rental, Parts and Service
 197 Ypao Road, Tamuning, Guam 96913
www.morricequipment.com
 Tel: 671-649-1946

STANDARD EQUIPMENT

OPERATOR ENVIRONMENT

See page 1

ENGINE

FPT F5H FL463 A
 Fuel filter with water trap
 Dual element air cleaner

LOADER

See page 2

DRIVETRAIN

4-wheel drive
 Open – front and rear axles
 Hydrostatic transmission
 Single joystick with electronic speed shift control F/N/R switch and proportional loader control
 Outboard planetary axles
 Hydraulic wet disc brakes
 Mechanical parking brake

HYDRAULICS

3-spool loader control valve
 3 Diagnostic quick couplers
 Adjustable electro hydraulic (EH) loader controls
 Smooth, moderate & aggressive settings for both lift and tilt responsiveness:
 Return to Dig
 Hydraulic skid steer compatible coupler
 Connect under pressure connectors
 Remote drain of hydraulic oil
 Aux. Hydraulic drain line coupling
 Auxiliary flow 22.5 gpm @ 3,336 psi (85 l/min @ 230 bar)

OTHER

Front and rear fenders
 Lights:
 2 Front driving headlights – high/low beam
 2 Rear flood lights
 2 Stop tail lights and backup light
 Front and rear turn signal/flash
 Drawbar pin
 Articulation locking pin
 Tie-down and Lift-up point – front and rear
 Backup alarm
 Tool box
 Rotating beacon
 Wired for radio
 Bucket position indicator
 Front electrical socket for powered attachments

OPTIONAL EQUIPMENT

OPERATOR ENVIRONMENT

Creep speed 0 – 3.1 mph (5 kph)
 TeleScoop adjustable steering column on Deluxe Cab
 Canopy cab
 Limited slip – front and rear axles
 100% lock – front and open rear axles
 Horizontal pin coupler
 Radio, antenna, and speakers

LOADER

Optional High flow:
 Max. 34.3 gpm @ 2500 RPM @ 2,901 psi (Max. 130 L/min @ 2500 RPM @ 20 000 kPa)
 Buckets – see performance data:
 General purpose standard
 General purpose light material
 STD forks
 Auto Ride Control
 Cold weather with Block Heater – Two 680 CCA batteries and Low-temp Hytran oil

TIRES

14.5-20MPT-04 MITAS
 365/80 R20 SPT9 L2(DL)
 365/70 R18 SPT9 L2 DUNL – Standard
 12.5-20 10PRMPT04TBL MITAS
 365/80 R20 EM MITAS
 365/70 R18 EM MITAS
 550/45 R22.5 Flotation Tire
 360/80 Nokian Tri 2 Snow

OTHER

CASE SiteWatch Telematics
 LED work lights, 2 front and 2 Rear



Sales, Rental, Parts and Service
 197 Ypao Road, Tamuning, Guam 96913
 www.morricequipment.com
 Tel: 671-649-1946

CaseCE.com

©2021 CNH Industrial America LLC. All rights reserved. CASE is a trademark registered in the United States and many other countries, owned by or licensed to CNH Global LLC, its subsidiaries or affiliates. CNH Industrial Capital is a trademark of the CNH Global Group. All other trademarks, registered or unregistered, are the property of their respective owners. Product literature, product photos and other information are subject to change without notice.

IMPORTANT: CASE Construction Equipment Inc. reserves the right to change these specifications without notice without incurring any obligation relating to such change. Availability of some models and equipment may vary according to the country in which the equipment is used. The Biodiesel version may include different equipment and accessories and related fluids. An optional equipment tour CASE distributor will be able to give you details of the products and their specifications available in your area.



CNHI Construction Equipment is an equal opportunity employer. All employees must comply with applicable laws and regulations. All specifications are stated in accordance with SAE Standards or Recommended Practices, unless specified.



Always read the Operator's Manual before operating any equipment. Inspect equipment before using it, and be sure it is operating properly. Follow the product safety signs and use any safety features provided.

TINK BUCKETS



Load A
Compactor Truck



Load An
Open Top Truck



Efficient Collection
Of Leaves & Brush



TINK, INC.

TITLE 520 Claw

DESIGN FEATURES

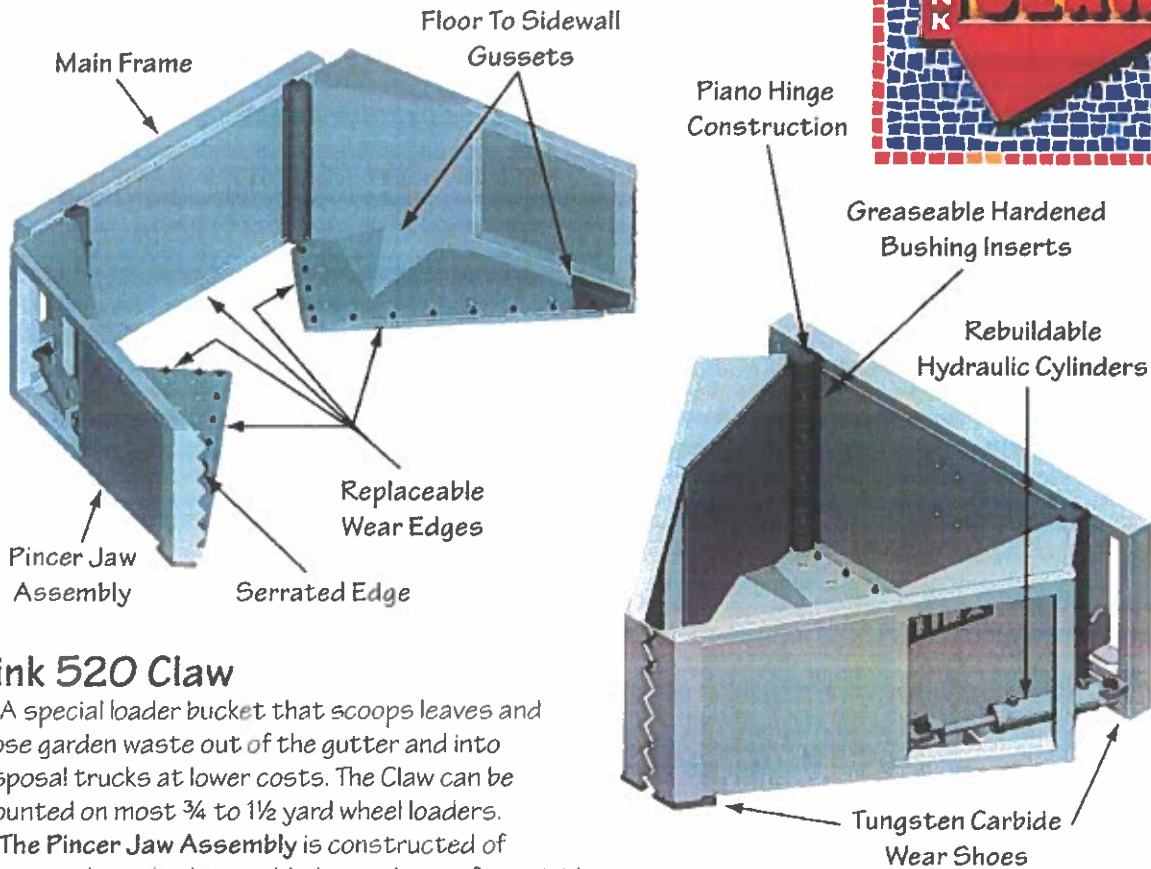

Tink 520 Claw

A special loader bucket that scoops leaves and loose garden waste out of the gutter and into disposal trucks at lower costs. The Claw can be mounted on most $\frac{3}{4}$ to $1\frac{1}{2}$ yard wheel loaders.

The **Pincer Jaw Assembly** is constructed of structural steel tubing welded together to form rigid rectangular frames. The framework is covered and strengthened with steel side panels. The serrated front edges assist in grasping and pinching materials.

Wear Provisions The underside of the Claw, which makes frequent contact with asphalt and other hard surfaces, is equipped with replaceable tungsten carbide wear shoes and hard steel blades that absorb a majority of the abrasion and wear. Tungsten carbide is an extremely hard material that is incorporated into the wear shoes to combine the highest wear and abrasion resistance possible with strength and impact resistance.

Piano-Hinge Construction The pincer jaw assembly is attached to the main frame with a 3 inch diameter piano-hinge that features a $1\frac{1}{2}$ inch pin that won't shear on impact. More importantly the large diameter provides a vast amount of wear surface to promote long lasting life. The hinges include greasable hardened bushing inserts.

Hydraulic System The rebuildable twin cylinders that open and close the Claw are capable of developing pinch force necessary to grasp and hold materials too long or bulky to fit within the pincer bucket. The cylinders have a 3 inch bore, an 8 inch stroke and a $\frac{1}{4}$ inch chrome hardened rod. Mechanical stops prevent cylinder damage by not allowing the cylinders to over extend during the Claw's duty cycle.

When the pincer jaws make contact with an immovable object the hydraulic cross over relief valve senses the obstruction a diverts the fluid away from the cylinders. This automatic action minimizes cylinder damage and premature hydraulic system failure.

The flow divider distributes an equal amount of hydraulic fluid to each cylinder ensuring that the pincer jaws operate evenly and simultaneously.

The 520 Claw hydraulic system is designed for machines having 8 to 50 gpm and 1500 to 3800 psi.

Prices and specifications are subject to change without notice.

TINK, Inc. • 2361 Durham Dayton Hwy • Durham CA 95938 • 800-824-4163 • © 2002

1. Bucket Broom suitable for Case Wheel Loader 221F equipped with Skid Steer Loader Mount

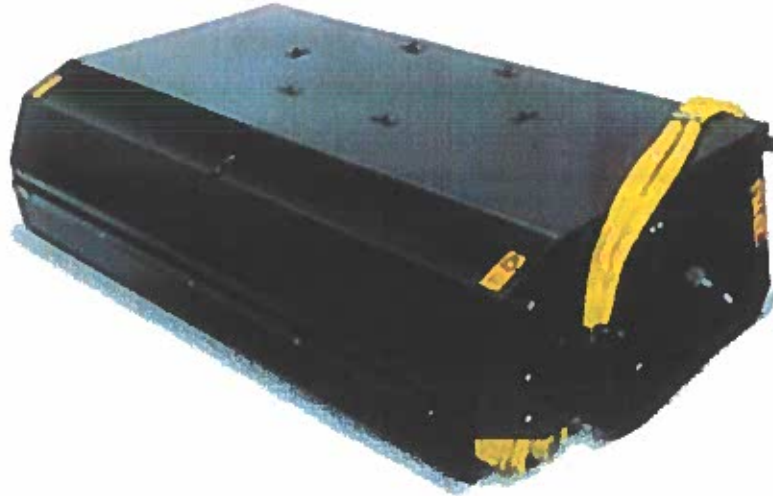

MORRIS
EQUIPMENT
Sales, Rental, Parts and Service
197 Ypao Road, Tamuning, Guam 96913
www.morrisequipment.com
Tel: 671-649-1946

Specifications / Features

- Handles light and heavy-duty clean-up in construction, municipal, and industrial applications
- Bi-directional broom sweeps forward to pick up dirt; reverses to collect asphalt millings, rock, and construction debris
- To dump, just lift and tilt; no chains are required
- No front caster wheel; works easily next to walls, curbs and obstacles
- Replaceable bolt-on cutting edge on bucket
- Mounts to skid-steer quick-attach
- Mechanical stops to adjust depth of the brush

2. Pallet Forks suitable for Case Wheel Loader 221F equipped with Skid Steer Loader Mount



MORRIS
EQUIPMENT
Sales, Rental, Parts and Service
197 Y.ao Road, Tamuning, Guam
www.morrisequipment.com
Tel: 671-649-1946

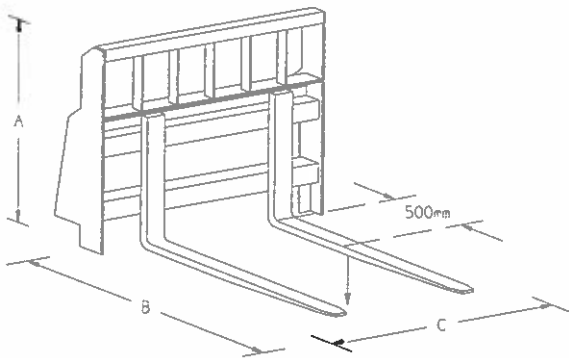

Specifications / Features

- CNHi's Pallet Forks are designed with a high strength lightweight frame.
- The Forks are equipped with guard for excellent visibility.
- The lifting capacity of the complete attachment is governed by the operating capacity of the host machine

MULTI-PURPOSE QUADRA-BUCKET

RECOMMENDED APPLICATIONS:

The Werk-Brau Multi-purpose Quadra-Bucket is specifically designed to add versatility to a standard loader bucket. Can be used for dozing, grappling, material handling, light grading, back dragging, back filling, land clearing, high dumping and much more. With vast variety of applications this bucket can perform deems bucket one of the most versatile attachment on any job site. Not designed to be used in heavy rock applications.



QUALITY CONSTRUCTION:

High strength, wear resistant steel is used in cutting edges. High quality cylinders are utilized in all models. All pivot points are greasable and lined with hardened bushings. Each bucket is engineered with tapered side plates to reduce wear on the buckets sides, and to allow for easier dumping.

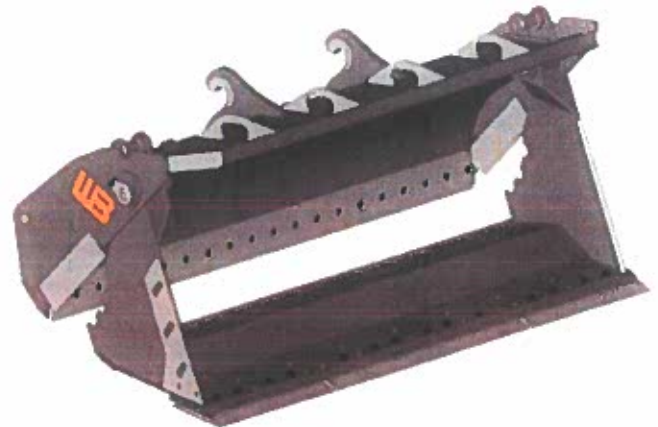

TOOTH EQUIPMENT OPTIONS:

Cutting edge can be drilled to accept bolt-on teeth or a replaceable bolt-on edge.

STANDARD SIZES AVAILABLE:

Specific widths and capacities made to meet customer requirements.

ADDITIONAL FEATURES:

All models fitted with attaching ears that meet all pertinent OEM specifications. Dozer edge is equipped with replaceable bolt on edge.



Sales, Rental, Parts and Service
197 Ypao Road, Tamuning, Guam 96913
www.morricoequipment.com
Tel: 671-649-1946

MULTI-PURPOSE QUADRA-BUCKET



Sales, Rental, Parts and Service
197 Ypao Road, Tamuning, Guam 96913
www.morricequipment.com
Tel: 671-649-1946

MULTI-PURPOSE QUADRA-BUCKETS

LOADER CLASS	PART NUMBER	BUCKET WIDTH	EDGE LENGTH	CAPACITY STRUCK	CAPACITY RATED	WEIGHT
BH	QB821L	82"	84"	0.85	1.00	1,600
BH	QB921L	92"	94"	1.06	1.25	1,800
BH	QB961L	96"	98"	1.17	1.38	1,950
1	QB1WL100-1.25	100"	103"	1.06	1.25	2,175
1	QB1WL100-1.50	100"	103"	1.27	1.50	2,475
1	QB1WL100-1.75	100"	103"	1.48	1.75	2,775
2	QB2WL100-1.50	100"	102"	1.27	1.50	2,775
2	QB2WL100-2.00	100"	102"	1.69	2.00	3,275
2	QB2WL100-2.50	100"	102"	2.12	2.50	3,675
3	QB3WL100-2.50	100"	102"	2.12	2.50	3,850
3	QB3WL100-3.00	100"	102"	2.54	3.00	4,050
3	QB3WL100-3.25	100"	102"	2.75	3.25	4,350
3.5	QB3.5WL105-3.00	105"	108"	2.54	3.00	4,050
3.5	QB3.5WL105-3.25	105"	108"	2.75	3.25	4,350
4	QB4WL117-3.25	117"	119"	2.75	3.25	4,450
4	QB4WL117-3.50	117"	119"	2.97	3.50	4,850
4	QB4WL117-3.75	117"	119"	3.18	3.75	5,050
5	QB5WL124-3.50	124"	126"	2.97	3.50	4,900
5	QB5WL124-4.00	124"	126"	3.39	4.00	5,100
5	QB5WL124-4.50	124"	126"	3.81	4.50	5,400
6	QB6WL132-5.00	132"	135"	4.24	5.00	6,300
6	QB6WL132-6.00	132"	135"	5.08	6.00	7,600
6	QB6WL132-7.00	132"	135"	5.93	7.00	8,000

GENERAL PURPOSE HIGH PERFORMANCE BUCKET

RECOMMENDED APPLICATIONS:

The Werk-Brau General Purpose High Performance Bucket has an enhanced high-performance profile. This bucket holds approximately 5% more than our General Purpose Bucket. Specifically designed to dig in virgin soil and re-handle materials up to 3,200 lbs/cubic yard in density.



QUALITY CONSTRUCTION:

High-strength, abrasion-resistant steel is utilized in all critical components. All seams are welded solid for extra durability. Each bucket is engineered with tapered side plates to reduce wear on the buckets sides, and to allow for easier dumping. It also has curved side plates for maximum material retention. An inclined bottom reduces loading force and an increased roll back angle for material retention. The beveled design also allows for a higher material retention.

TOOTH EQUIPMENT OPTIONS:

Auxiliary edge and teeth are available upon request.

STANDARD SIZES AVAILABLE:

2.0 cu. yd. to 9.0 cu. yd. of various widths are available. Special designs and capacities available upon request.

ADDITIONAL FEATURES:

Bucket design incorporates an inclined bottom to reduce loading forces. Strong top design withstands high-digging forces exerted by today's machines, and curved side wall to allow to a higher yield in capacity.



Sales, Rental, Parts and Service
197 Ypao Road, Tamuning, Guam 96913
www.morricequipment.com
Tel: 671-649-1946

GENERAL PURPOSE HIGH PERFORMANCE BUCKET

GENERAL PURPOSE HIGH PERFORMANCE LOADER BUCKETS

LOADER CLASS	PART NUMBER	BUCKET WIDTH	EDGE LENGTH	CAPACITY STRUCK	CAPACITY RATED	WEIGHT
BH	WBLH82-1.00	82"	83"	0.85	1.00	1,050
BH	WBLH92-1.25	92"	93"	1.06	1.25	1,125
BH	WBLH96-1.50	96"	97"	1.27	1.50	1,200
MINI	LHG055450	54"	55"	0.42	0.50	700
MINI	LHG056275	62"	63"	0.64	0.75	775
MINI	LHG0574100	74"	75"	0.85	1.00	825
MINI	LHG0574125	74"	75"	1.00	1.25	890
1	LHG14750	47"	48"	0.42	0.50	850
1	LHG166100	66"	69"	0.85	1.00	1,050
1	LHG188125	88"	91"	1.06	1.25	1,300
1	LHG196150	96"	99"	1.27	1.50	1,675
1	*LHG1100200	100"	102"	1.69	2.00	1,850
1	*LHG1100225	100"	102"	1.91	2.25	1,900
1	*LHG1100250	100"	102"	2.17	2.50	1,925
2	*LHG2100200	100"	102"	1.69	2.00	1,775
2	*LHG2100225	100"	102"	1.91	2.25	1,875
2	*LHG2100250	100"	102"	2.17	2.50	1,975
2	*LHG2100275	100"	102"	2.33	2.75	2,075
2	*LHG2100300	100"	102"	2.54	3.00	2,175
3	*LHG3100250	100"	102"	2.17	2.50	2,250
3	*LHG3100275	100"	102"	2.33	2.75	2,350
3	*LHG3100300	100"	102"	2.54	3.00	2,450



Sales, Rental, Parts and Service
197 Ypao Road, Tamuning, Guam 96913
www.morricequipment.com

Tel: 671-649-1946

PROUDLY MADE IN FINDLAY OHIO 

Werk-Brau.com 1-800-537-9561





DEPARTMENT OF REVENUE AND TAXATION
GOVERNMENT OF GUAM
P.O. Box 23607
Barrigada, Guam 96921

BUSINESS LICENSE

SRL NO: 2402124

R

Ltd Liability Company Retail
EXPIRES 01/31/2024 **ACCOUNT** 30-200400017-001

FEE	1000 00
PENALTY	17 00
TOTAL FEE	1017 00

ISSUED MORRICO EQUIPMENT, LLC
DONG BUSINESS MORRICO EQUIPMENT, LLC

TYPE OF LICENSE: SALE OF TRUCKS, FORKLIFTS, GENERATORS,
& OTHER HEAVY EQUIPMENT & RELATED PARTS

BUSINESS LOT 2144-1B-R5-NEW1 & R/W
TAMUNING GUAM

MAILING 197 YPAO RD
TAMUNING GUAM

TELEPHONE:

ZIP: 96913
BUSINESS 649-1946

2/17/23

PAID

FEB 17 2023

Treasurer of Guam

12

KEEP POSTED IN A CONSPICUOUS
PLACE. LICENSE MUST BE PRODUCED
UPON DEMAND TO ANY AUTHORIZED
GOVT OFFICIAL

John M. Shimizu
John M. Shimizu
DIRECTOR OF REVENUE AND TAXATION



DEPARTMENT OF REVENUE AND TAXATION
GOVERNMENT OF GUAM
P.O. Box 23607
Sanigarda, Guam 96921

BUSINESS LICENSE

SRL NO: 2402123

R

Ltd Liability Company Wholesale
EXPIRES 01/31/2024 **ACCOUNT** 20-200400017-001

ISSUED	MORRICO EQUIPMENT, LLC	FEE	100 00
DONG BUSINESS	MORRICO EQUIPMENT, LLC	PENALTY	17 00
		TOTAL FEE	117 00

TYPE OF LICENSE: WHOLESALE OF EQUIPMENT SPARE PARTS & RELATED ITEMS

PAID

FEB 17 2024
Treasurer of Guam
\$2

LOT 2144-1B-R5-NEW1 & R/W
TAMUNING GUAM

Mailing
197 YPAO RD
TAMUNING GUAM

ZIP: 96913

BUSINESS

648-1946

TELEPHONE:

2/17/23

KEEP POSTED IN A CONSPICUOUS PLACE. LICENSE MUST BE PRODUCED UPON DEMAND TO ANY AUTHORIZED GOV'T OFFICIAL

John H. Shinjizu
Dafnansan It-Shinjizu
DIRECTOR OF REVENUE AND TAXATION



DEPARTMENT OF REVENUE AND TAXATION
GOVERNMENT OF GUAM
PO. Box 23607
Baniaga, Guam 96821

BUSINESS LICENSE

SRL NO: 2402119

R

Ltd Liability Company Service
EXPIRES 01/31/2024 ACCOUNT 13-200400017-001

ISSUED MORRICO EQUIPMENT, LLC
DONG BUSINESS MORRICO EQUIPMENT, LLC

TYPE OF LICENSE: REPAIR OF HEAVY EQUIPMENT

BUSINESS LOT 2144-1B-R5-NEW1 & R/W
TAMUNING GUAM

MAILING 197 YPAO RD
TAMUNING GUAM

TELEPHONE: BUSINESS 648-1946 ZIP: 96913

2/17/23

FEE	50.00
PENALTY	17.00
TOTAL FEE	67.00



KEEP POSTED IN A CONSPICUOUS
PLACE. LICENSE MUST BE PRODUCED
UPON DEMAND TO ANY AUTHORIZED
GOVT OFFICIAL

Dafne Mansapit-Shimizu
Dafne Mansapit-Shimizu
DIRECTOR OF REVENUE AND TAXATION



GSWA PROCUREMENT RECORD Page 172
GUAM SOLID WASTE AUTHORITY

LOURDES A. LEON GUERRERO
 Governor of Guam

JOSHUA F. TENORIO
 Lt. Governor of Guam

IRVIN L. SLIKE
 General Manager



INVITATION FOR BID NO.: GSWA-004-24

DESCRIPTION: COMPACT WHEEL LOADER W/ ATTACHMENTS

SPECIAL REMINDER TO PROSPECTIVE BIDDERS

ORIGINAL

Bidders are reminded to read the Sealed Bid Solicitation and Instructions, and General Terms and Conditions attached to the IFB to ascertain that all of the following requirements checked below are submitted in the bid envelope, in duplicate, and the date and time for bid opening.

- (X) **BID GUARANTEE (15% of Bid Amount) May be in the form of;**
Reference #11 on the General Terms and Conditions
 - a. Cashier's Check or Certified Check
 - b. Letter of Credit
 - c. Surety Bond – Valid only if accompanied by:
 - 1. Current Certificate of Authority issued by the Insurance Commissioner;
 - 2. Power of Attorney issued by the Surety to the Resident General Agent;
 - 3. Power of Attorney issued by two (2) major officers of the Surety to whoever is signing on their behalf.

- (X) **BROCHURES/DESCRIPTIVE LITERATURE;**

- (X) **AFFIDAVIT DISCLOSING OWNERSHIP, INFLUENCE, COMMISSION, & CONFLICT OF INTEREST**
 - a. Date of signature of the person authorize to sign the bid and the notary date must be the same.

- (X) **OTHER REQUIREMENTS:**
Affidavit re Non-Collusion, Affidavit re No Gratuities or Kickbacks, Affidavit re Ethical Standards, Affidavit D.O.L. Wage Determination, Affidavit re Contingent Fees, Special Provision; Restriction Against Sexual Offenders

- (X) **CURRENT BUSINESS LICENSE / CONTRACTOR'S LICENSE / SPECIALTY LICENSE**
IN REFERENCE TO SUPPLIES OR SERVICES FOR THIS BID

This reminder must be signed and returned in the bid envelope together with the bid. Failure to comply with the above requirements may be cause for disqualification and rejection of bid.

On this 14th day of November, 2023, I John Alexius Limtiaco Jr, authorized representative of Far East Equipment Company, LLC acknowledge receipt of this special reminder to prospective bidders with the above referenced IFB.

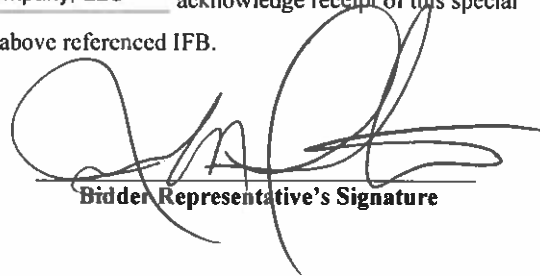

Bidder Representative's Signature



GUAM SOLID WASTE AUTHORITY

LOURDES A. LEON GUERRERO
Governor of Guam

JOSHUA F. TENORIO
Lt. Governor of Guam

IRVIN L. SLIKE
General Manager



INVITATION FOR BID

ISSUING OFFICE:

IRVIN L. SLIKE
General Manager

10/31/23
DATE

GUAM SOLID WASTE AUTHORITY
546 NORTH MARINE CORPS DRIVE
TAMUNING, GUAM 96913

DATE ISSUED: 11/03/2023
BID INVITATION NO.: GSWA-004-24
BID FOR: COMPACT WHEEL LOADER W/ ATTACHMENTS
SPECIFICATION: SEE ATTACHED
DESTINATION: GUAM SOLID WASTE AUTHORITY
REQUIRED DELIVERY DATE: 200 DAYS UPON RECEIPT OF PURCHASE ORDER

INSTRUCTIONS TO BIDDERS:

INDICATE WHETHER: INDIVIDUAL PARTNERSHIP CORPORATION
INCORPORATED IN: Guam

This bid shall be submitted in duplicate and sealed to the issuing office no later than (Time) **1:00PM**,
Date: **11/20/2023**, and shall be publicly opened. Bid submitted after the time and date specified above shall be rejected.
See attached General Terms and Conditions and Sealed Bid Solicitation for details.

The undersigned offers and agrees to furnish within the time specified, the articles and services at the price stated opposite the respective items listed on the schedule provided, unless otherwise specified by the bidder. In consideration to the expense of the Government in opening, tabulating, and evaluating this and other bids, and other considerations, the undersigned agrees that this bid remain firm and irrevocable within one hundred twenty (120) calendar days from the date opening to supply any or all the items which prices are quoted.

NAME AND ADDRESS OF BIDDER:
Far East Equipment Company, LLC
P.O. Box 10838
Tamuning, GU 96931

SIGNATURE AND TITLE OF PERSON
AUTHORIZED TO SIGN THIS BID:

John Alexis Lim, Jr. / President

AWARD: CONTRACT NO.: _____ AMOUNT: _____ DATE: _____

ITEM NO(S). AWARDED: _____

CONTRACTING OFFICER:

IRVIN L. SLIKE DATE
General Manager

NAME AND ADDRESS OF CONTRACTOR:

SIGNATURE AND TITLE OF PERSON
AUTHORIZED TO SIGN THIS CONTRACT:

**AFFIDAVIT DISCLOSING OWNERSHIP, INFLUENCE, COMMISSIONS AND
CONFLICTS OF INTEREST**

(Required by 5 GCA § 5233 as amended by P.L. 36-13 (4/9/2021))

CITY OF Hagatna)
) ss.
 ISLAND OF GUAM)

Preface. As a condition of submitting a Bid/Offer/Proposal or responding to any method of source selection under Guam’s Procurement Law for the purpose of entering into a contract with the government of Guam, this Affidavit requires all Bidders/Offerors/Prospective Contractors to make disclosures of ownership, influence, commissions, gratuities, kickbacks, and conflicts of interest occurring **during the 365 calendar days preceding the publication of this solicitation and until award of a contract.** This includes the duty to disclose **any changes** to the facts disclosed herein throughout the solicitation process; and if the entity submitting this Affidavit is awarded a contract, the duty to disclose **any changes** to the facts disclosed herein **continues throughout the life of the contract, including any extensions or renewals.**

A. I, the undersigned, being first duly sworn, depose and say that I am an authorized representative of the Bidder/Offeror/Prospective Contractor and that (please check and fill out all that apply):

The Bidder/Offeror/Prospective Contractor is an individual with a business license, and all decisions are by, and all profit is for, that same individual, with principal place of business street address being: _____

The Bidder/Offeror/Prospective Contractor is a business or artificial person (as defined in 1 GCA § 715 or 5 GCA §§ 5030(n) or 5233(b)), and is a sole proprietorship owned entirely (100%) by _____, with principal place of business street address being: _____

The Bidder/Offeror/Prospective Contractor is a business or artificial person (as defined in 1 GCA § 715 or 5 GCA §§ 5030(n) or 5233(b)), and is owned by the following multiple individuals. Note: owners of more than 10% are statutorily required to be listed below, but other owners of smaller percentage are encouraged to be listed as well.

Name of Owner	Principal Place of Business Street Address	% of Interest
<u>Pacific Unlimited Inc.</u>	<u>P.O. Box 10838 Tamuning, GU 96931</u>	<u>100%</u>
_____	_____	_____
_____	_____	_____
_____	_____	_____

Affidavit Disclosing Ownership, Influence,
Commissions and Conflicts of Interest
AG Procurement Form 002 (Rev. 11/17/2021)

One or more of the more-than-10% owners listed above is a business or artificial person. Any more-than-25% owners of such a business or artificial person are listed below per 5 GCA § 5233. Note: any less-than-25% owners of such a business or artificial person is encouraged to also be listed below.

Name of >10% Owner Business or Artificial Person:

Pacific Unlimited Inc.	100%
------------------------	------

Names of owners of the >10% Owner Business or Artificial Person ("Second Tier Owner")	Owner's Principal Place of Business Street Address	% of Interest
John A. Limtiaco	P.O. Box 10838 Tamuning, GU 96931	52%
Lawrence V. Limtiaco	P.O. Box 10838 Tamuning, GU 96931	22.5%
Selita L. Limtiaco	P.O. Box 10838 Tamuning, GU 96931	15.5%
Michael T. Limtiaco	P.O. Box 10838 Tamuning, GU 96931	10%

Name of other >10% Owner Business or Artificial Person:

--

Names of owners of the >10% Owner Business or Artificial Person ("Second Tier Owner")	Owner's Principal Place of Business Street Address	% of Interest

B. If any Second Tier Owner identified above is an artificial person, the natural or artificial owners of such Second Tier Owner who have held more than 49% of the shares or interest in the Bidder/Offeror/Prospective Contractor (Third Tier Owners) are as follows [if none, please so state]:

Second Tier Owner Name _____

Name of Third Tier Owner	Principal Place of Business Street Address	% of Interest

Affidavit Disclosing Ownership, Influence,
Commissions and Conflicts of Interest
AG Procurement Form 002 (Rev. 11/17/2021)

C. If the name of no natural person has been identified as an owner, or a Second or Third Tier Owner of the Bidder/Offeror/Prospective Contractor, please identify the name, position, address, and contact information of the natural person having the authority and responsibility for the Bid/Offer/Proposal/Prospective Contract, and the name of any natural person who has the authority and power to remove and replace the designated responsible person:

Name of Natural Person	Position	Street Address of Principal Place of Business	Phone Number, Email Address, and other Contact Information
John Alexius Limtiaco Jr.	President	P.O. Box 10838 Tamuning, GU 96931	671-888-6270

D. Further, I say that the persons who have received or are entitled to receive a commission, gratuity, contingent fee or other compensation to solicit, secure, or assist in obtaining business related to the Bid/Offer/Proposal/Prospective Contract for which this Affidavit is submitted are as follows (if none, please so state):

Name	Principal Place of Business Street Address	Amount of Compensation
N/A	N/A	N/A

E. Further, I say that the persons who have directly or indirectly participated in this solicitation and who are also employees of the government of Guam or the government of the United States, if federal funds are to be used in the payment of the contract related to the Bid/Offer/Proposal/Prospective Contract for which this Affidavit is submitted, are as follows (if none, please so state):

Name	Principal Place of Business Street Address
N/A	N/A

F. Regardless of any ownership interest, the following individuals have the power to control the performance of the contract or to control the Bidder/Offeror/Prospective Contractor, directly or indirectly:

Name	Principal Place of Business Street Address
N/A	N/A

///
///

Affidavit Disclosing Ownership, Influence,
Commissions and Conflicts of Interest
AG Procurement Form 002 (Rev. 11/17/2021)

G. Until award of the contract, and throughout the term of any contract awarded to the Bidder/Offeror/Prospective Contractor represented herein, I agree to promptly make any disclosures not made previously and update changes in ownership, identities of owners and other required information, interests, compensation or conflicts of the persons required to be disclosed. I understand that failure to comply with this requirement shall constitute a material breach of contract.

H. I hereby declare under penalty of perjury under the laws of Guam that the foregoing is true and correct.

Executed on: 11-17-2023
(date)

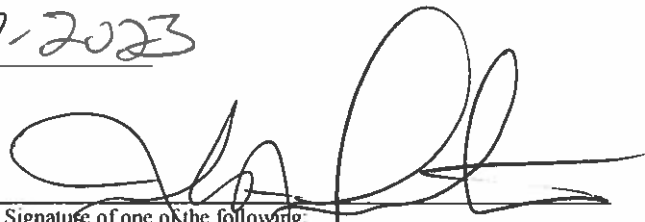

Signature of one of the following:
Bidder/Offeror/Prospective Contractor, if a licensed individual
Owner of sole proprietorship Bidder/Offeror/Prospective
Contractor
Partner, if the Bidder/Offeror/Prospective Contractor is a
partnership
Officer, if the Bidder/Offeror/Prospective Contractor is a
corporation

Subscribed and sworn to before me

This 17th day of November, 20 23.



NOTARY PUBLIC

My commission expires: November 3, 2025

RENEE ANN C. WADE
NOTARY PUBLIC
In and for the Territory of Guam, U.S.A.
My Commission Expires: **NOV. 03, 2025**
111 Chalan Santo Papa Hagåtña, Guam 96910



AFFIDAVIT RE NON-COLLUSION

CITY OF Hagatna)
) SS.
ISLAND OF GUAM)

John Alexius Lirtiaco Jr. [state name of affiant signing below], being first duly sworn, deposes and says that:

1. The name of the offering company or individual is [state name of company] Far East Equipment Company, LLC

2. The proposal for the solicitation identified above is genuine and not collusive or a sham. The offeror has not colluded, conspired, connived or agreed, directly or indirectly, with any other offeror or person, to put in a sham proposal or to refrain from making an offer. The offeror has not in any manner, directly or indirectly, sought by an agreement or collusion, or communication or conference, with any person to fix the proposal price of offeror or of any other offeror, or to fix any overhead, profit or cost element of said proposal price, or of that of any other offeror, or to secure any advantage against the government of Guam or any other offeror, or to secure any advantage against the government of Guam or any person interested in the proposed contract. All statements in this affidavit and in the proposal are true to the best of the knowledge of the undersigned. This statement is made pursuant to 2 GAR Division 4 § 3126(b).

3. I make this statement on behalf of myself as a representative of the offeror, and on behalf of the offeror's officers, representatives, agents, subcontractors, and employees.

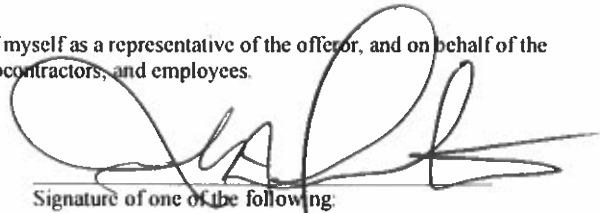

Signature of one of the following:

- Offeror, if the offeror is an individual,
- Partner, if the offeror is a partnership,
- Officer, if the offeror is a corporation.

Subscribed and sworn to before me

this 17th day of November, 2023

NOTARY PUBLIC
My commission expires November 3, 2025

RENEE ANN C. WADE
NOTARY PUBLIC
In and for the Territory of Guam, U.S.A.
My Commission Expires: **NOV. 03, 2025**
111 Chalan Santo Papa Hagåtña, Guam 96910

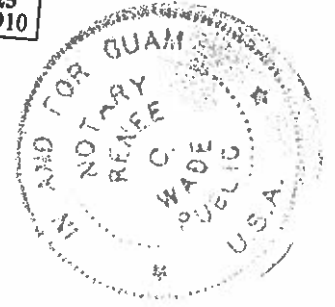

AG Procurement Form 003 (Jul. 12, 2010)

AFFIDAVIT re NO GRATUITIES or KICKBACKS

CITY OF Hagatna)
) ss.
ISLAND OF GUAM)

John Alexius Limtiaco Jr. [state name of affiant signing below], being first duly sworn, deposes and says that:

1. The name of the offering firm or individual is [state name of offeror company] Far East Equipment Company, LLC. Affiant is President [state one of the following: the offeror, a partner of the offeror, an officer of the offeror] making the foregoing identified bid or proposal.

2. To the best of affiant's knowledge, neither affiant, nor any of the offeror's officers, representatives, agents, subcontractors, or employees have violated, are violating the prohibition against gratuities and kickbacks set forth in 2 GAR Division 4 § 11107(e). Further, affiant promises, on behalf of offeror, not to violate the prohibition against gratuities and kickbacks as set forth in 2 GAR Division 4 § 11107(e).

3. To the best of affiant's knowledge, neither affiant, nor any of the offeror's officers, representatives, agents, subcontractors, or employees have offered, given or agreed to give, any government of Guam employee or former government employee, any payment, gift, kickback, gratuity or offer of employment in connection with the offeror's proposal.

4. I make these statements on behalf of myself as a representative of the offeror, and on behalf of the offeror's officers, representatives, agents, subcontractors, and employees.

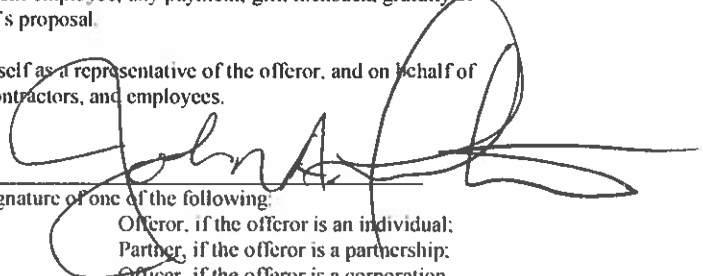

Signature of one of the following:
Offeror, if the offeror is an individual;
Partner, if the offeror is a partnership;
Officer, if the offeror is a corporation.

Subscribed and sworn to before me

this 17th day of November, 2023



NOTARY PUBLIC

My commission expires November 03, 2025.

RENEE ANN C. WADE
NOTARY PUBLIC
In and for the Territory of Guam, U.S.A.
My Commission Expires: **NOV. 03, 2025**
111 Chalan Santo Papa Hagåtña, Guam 96910



AFFIDAVIT RE ETHICAL STANDARDS

CITY OF Hagatna)
) ss.
ISLAND OF GUAM)

John Alexius Limtiaco Jr. [state name of affiant signing below], being first
duly sworn, deposes and says that:

The affiant is President [state one of the following: the offeror,
a partner of the offeror, an officer of the offeror] making the foregoing identified bid or proposal. To the
best of affiant's knowledge, neither affiant nor any officers, representatives, agents, subcontractors or
employees of offeror have knowingly influenced any government of Guam employee to breach any of the
ethical standards set forth in 5 GCA Chapter 5, Article 11. Further, affiant promises that neither he or
she, nor any officer, representative, agent, subcontractor, or employee of offeror will knowingly
influence any government of Guam employee to breach any ethical standards set forth in 5 GCA Chapter
5, Article 11. These statements are made pursuant to 2 GAR Division 4 § 11103(b).

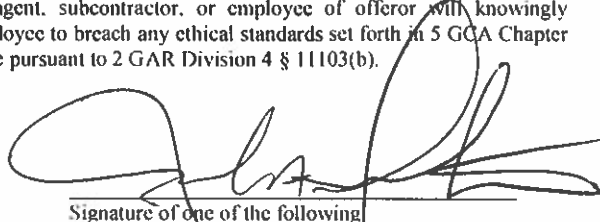

Signature of one of the following
Offeror, if the offeror is an individual;
Partner, if the offeror is a partnership;
Officer, if the offeror is a corporation.

Subscribed and sworn to before me ^R
this 17th day of November, 2023

NOTARY PUBLIC
My commission expires November 03, 2025

RENEE ANN C. WADE
NOTARY PUBLIC
In and for the Territory of Guam, U.S.A.
My Commission Expires: **NOV. 03, 2025**
111 Chalan Santo Papa Hagatna, Guam 96910



DECLARATION RE COMPLIANCE WITH U.S. DOI WAGE DETERMINATION

Procurement No.: GSWA-004-24

Name of Offeror Company Far East Equipment Company, LLC

I, John Alexius Limtiaco Jr. hereby certify under penalty of perjury:

(1) That I am President [please select one: the offeror, a partner of the offeror, an officer of the offeror] making the bid or proposal in the foregoing identified procurement;

(2) That I have read and understand the provisions of 5 GCA § 5801 and § 5802 which read:

§ 5801. Wage Determination Established.

In such cases where the government of Guam enters into contractual arrangements with a sole proprietorship, a partnership or a corporation ("contractor") for the provision of a service to the government of Guam, and in such cases where the contractor employs a person(s) whose purpose, in whole or in part, is the direct delivery of service contracted by the government of Guam, then the contractor shall pay such employee(s) in accordance with the Wage Determination for Guam and the Northern Mariana Islands issued and promulgated by the U.S. Department of Labor for such labor as is employed in the direct delivery of contract deliverables to the government of Guam.

The Wage Determination most recently issued by the U.S. Department of Labor at the time a contract is awarded to a contractor by the government of Guam shall be used to determine wages, which shall be paid to employees pursuant to this Article. Should any contract contain a renewal clause, then at the time of renewal adjustments, there shall be made stipulations contained in that contract for applying the Wage Determination, as required by this Article, so that the Wage Determination promulgated by the U.S. Department of Labor on a date most recent to the renewal date shall apply.

§ 5802. Benefits.

In addition to the Wage Determination detailed in this Article, any contract to which this Article applies shall also contain provisions mandating health and similar benefits for employees covered by this Article, such benefits having a minimum value as detailed in the Wage Determination issued and promulgated by the U.S. Department of Labor, and shall contain provisions guaranteeing a minimum of ten (10) paid holidays per annum per employee.

(3) That the offeror is in full compliance with 5 GCA § 5801 and § 5802, as may be applicable to the procurement referenced herein.

(4) That I have attached the most recent wage determination applicable to Guam issued by the U.S. Department of Labor. [INSTRUCTIONS - Please attach!]

Signature

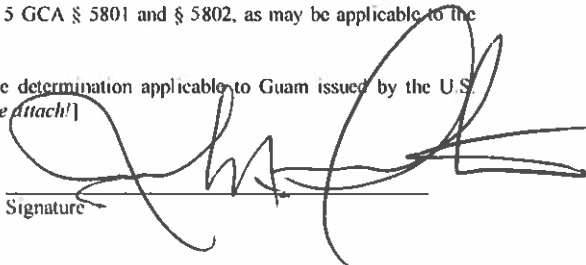

GSWA PROCUREMENT RECORD Page 182

"REGISTER OF WAGE DETERMINATIONS UNDER THE SERVICE CONTRACT ACT By direction of the Secretary of Labor	U.S. DEPARTMENT OF LABOR EMPLOYMENT STANDARDS ADMINISTRATION WAGE AND HOUR DIVISION WASHINGTON D.C. 20210
--	--

Daniel W. Simms Director	Division of Wage Determinations	Wage Determination No.: 2015-5693 Revision No.: 19 Date Of Last Revision: 07/17/2023
-----------------------------	------------------------------------	--

Note: Contracts subject to the Service Contract Act are generally required to pay at least the applicable minimum wage rate required under Executive Order 14026.

If the contract is entered into on or after January 30, 2022, or the contract is renewed or extended (e.g., an option is exercised) on or after January 30, 2022:	Executive Order 14026 generally applies to the contract. The contractor must pay all covered workers at least \$16.20 per hour (or the applicable wage rate listed on this wage determination, if it is higher) for all hours spent performing on the contract in 2023.
---	--

The applicable Executive Order minimum wage rate will be adjusted annually. Additional information on contractor requirements and worker protections under the Executive Orders is available at www.dol.gov/whd/govcontracts.

States: Guam, Northern Marianas, Wake Island

Area: Guam Statewide
 Northern Marianas Statewide
 Wake Island Statewide

****Fringe Benefits Required Follow the Occupational Listing****

OCCUPATION CODE - TITLE	FOOTNOTE	RATE
01000 - Administrative Support And Clerical Occupations		
01011 - Accounting Clerk I		14.27***
01012 - Accounting Clerk II		16.02***
01013 - Accounting Clerk III		17.93
01020 - Administrative Assistant		21.43
01035 - Court Reporter		17.40
01041 - Customer Service Representative I		12.75***
01042 - Customer Service Representative II		14.23***
01043 - Customer Service Representative III		15.62***
01051 - Data Entry Operator I		12.16***
01052 - Data Entry Operator II		13.27***
01060 - Dispatcher, Motor Vehicle		17.39
01070 - Document Preparation Clerk		13.85***
01090 - Duplicating Machine Operator		13.85***
01111 - General Clerk I		11.33***
01112 - General Clerk II		12.36***
01113 - General Clerk III		13.88***
01120 - Housing Referral Assistant		19.39
01141 - Messenger Courier		11.37***
01191 - Order Clerk I		12.57***
01192 - Order Clerk II		13.71***
01261 - Personnel Assistant (Employment) I		15.95***
01262 - Personnel Assistant (Employment) II		17.85
01263 - Personnel Assistant (Employment) III		19.89
01270 - Production Control Clerk		22.97
01290 - Rental Clerk		11.10***
01300 - Scheduler, Maintenance		15.55***
01311 - Secretary I		15.55***
01312 - Secretary II		17.40
01313 - Secretary III		19.39
01320 - Service Order Dispatcher		15.40***
01410 - Supply Technician		21.43
01420 - Survey Worker		16.96
01460 - Switchboard Operator/Receptionist		10.78***
01531 - Travel Clerk I		13.01***
01532 - Travel Clerk II		14.12***
01533 - Travel Clerk III		15.09***
01611 - Word Processor I		14.53***

GSWA PROCUREMENT RECORD Page 183

01612 - Word Processor II	16.31
01613 - Word Processor III	18.26
05000 - Automotive Service Occupations	
05005 - Automobile Body Repairer, Fiberglass	17.20
05010 - Automotive Electrician	16.16***
05040 - Automotive Glass Installer	15.11***
05070 - Automotive Worker	15.11***
05110 - Mobile Equipment Servicer	12.96***
05130 - Motor Equipment Metal Mechanic	17.20
05160 - Motor Equipment Metal Worker	15.11***
05190 - Motor Vehicle Mechanic	17.20
05220 - Motor Vehicle Mechanic Helper	11.87***
05250 - Motor Vehicle Upholstery Worker	14.06***
05280 - Motor Vehicle Wrecker	15.11***
05310 - Painter, Automotive	16.16***
05340 - Radiator Repair Specialist	15.11***
05370 - Tire Repairer	12.67***
05400 - Transmission Repair Specialist	17.20
07000 - Food Preparation And Service Occupations	
07010 - Baker	11.10***
07041 - Cook I	14.44***
07042 - Cook II	16.84
07070 - Dishwasher	9.69***
07130 - Food Service Worker	10.11***
07210 - Meat Cutter	13.34***
07260 - Waiter/Waitress	9.73***
09000 - Furniture Maintenance And Repair Occupations	
09010 - Electrostatic Spray Painter	18.75
09040 - Furniture Handler	11.37***
09080 - Furniture Refinisher	18.75
09090 - Furniture Refinisher Helper	13.77***
09110 - Furniture Repairer, Minor	16.32
09130 - Upholsterer	18.75
11000 - General Services And Support Occupations	
11030 - Cleaner, Vehicles	9.69***
11060 - Elevator Operator	9.69***
11090 - Gardener	14.28***
11122 - Housekeeping Aide	10.13***
11150 - Janitor	10.13***
11210 - Laborer, Grounds Maintenance	10.79***
11240 - Maid or Houseman	9.67***
11260 - Pruner	9.66***
11270 - Tractor Operator	13.07***
11330 - Trail Maintenance Worker	10.79***
11360 - Window Cleaner	11.32***
12000 - Health Occupations	
12010 - Ambulance Driver	18.96
12011 - Breath Alcohol Technician	18.96
12012 - Certified Occupational Therapist Assistant	26.02
12015 - Certified Physical Therapist Assistant	26.02
12020 - Dental Assistant	18.79
12025 - Dental Hygienist	39.73
12030 - EKG Technician	28.73
12035 - Electroneurodiagnostic Technologist	28.73
12040 - Emergency Medical Technician	18.96
12071 - Licensed Practical Nurse I	16.95
12072 - Licensed Practical Nurse II	18.96
12073 - Licensed Practical Nurse III	21.14
12100 - Medical Assistant	13.42***
12130 - Medical Laboratory Technician	18.82
12160 - Medical Record Clerk	14.97***
12190 - Medical Record Technician	17.77
12195 - Medical Transcriptionist	16.95
12210 - Nuclear Medicine Technologist	41.68
12221 - Nursing Assistant I	12.43***
12222 - Nursing Assistant II	13.97***
12223 - Nursing Assistant III	15.24***
12224 - Nursing Assistant IV	17.12
12235 - Optical Dispenser	18.96
12236 - Optical Technician	16.95
12250 - Pharmacy Technician	15.49***
12280 - Phlebotomist	16.95
12305 - Radiologic Technologist	28.73
12311 - Registered Nurse I	23.50
12312 - Registered Nurse II	28.73
12313 - Registered Nurse II, Specialist	28.73
12314 - Registered Nurse III	34.76
12315 - Registered Nurse III, Anesthetist	34.76
12316 - Registered Nurse IV	41.68
12317 - Scheduler (Drug and Alcohol Testing)	23.50

12320 - Substance Abuse Treatment Counselor	23.50
13000 - Information And Arts Occupations	
13011 - Exhibits Specialist I	21.42
13012 - Exhibits Specialist II	26.53
13013 - Exhibits Specialist III	32.45
13041 - Illustrator I	21.42
13042 - Illustrator II	26.53
13043 - Illustrator III	32.45
13047 - Librarian	29.38
13050 - Library Aide/Clerk	17.05
13054 - Library Information Technology Systems Administrator	26.53
13058 - Library Technician	18.11
13061 - Media Specialist I	19.15
13062 - Media Specialist II	21.42
13063 - Media Specialist III	23.87
13071 - Photographer I	19.15
13072 - Photographer II	21.42
13073 - Photographer III	26.53
13074 - Photographer IV	32.45
13075 - Photographer V	39.27
13090 - Technical Order Library Clerk	21.42
13110 - Video Teleconference Technician	19.15
14000 - Information Technology Occupations	
14041 - Computer Operator I	15.71***
14042 - Computer Operator II	17.22
14043 - Computer Operator III	19.19
14044 - Computer Operator IV	21.33
14045 - Computer Operator V	23.62
14071 - Computer Programmer I	(see 1) 15.73***
14072 - Computer Programmer II	(see 1) 19.50
14073 - Computer Programmer III	(see 1) 23.84
14074 - Computer Programmer IV	(see 1)
14101 - Computer Systems Analyst I	(see 1) 24.23
14102 - Computer Systems Analyst II	(see 1)
14103 - Computer Systems Analyst III	(see 1)
14150 - Peripheral Equipment Operator	15.71***
14160 - Personal Computer Support Technician	21.33
14170 - System Support Specialist	21.24
15000 - Instructional Occupations	
15010 - Aircrew Training Devices Instructor (Non-Rated)	24.23
15020 - Aircrew Training Devices Instructor (Rated)	29.32
15030 - Air Crew Training Devices Instructor (Pilot)	34.91
15050 - Computer Based Training Specialist / Instructor	24.23
15060 - Educational Technologist	29.40
15070 - Flight Instructor (Pilot)	34.91
15080 - Graphic Artist	20.47
15085 - Maintenance Test Pilot, Fixed, Jet/Prop	34.91
15086 - Maintenance Test Pilot, Rotary Wing	34.91
15088 - Non-Maintenance Test/Co-Pilot	34.91
15090 - Technical Instructor	17.67
15095 - Technical Instructor/Course Developer	23.78
15110 - Test Proctor	15.70***
15120 - Tutor	15.70***
16000 - Laundry, Dry-Cleaning, Pressing And Related Occupations	
16010 - Assembler	10.83***
16030 - Counter Attendant	10.83***
16040 - Dry Cleaner	12.36***
16070 - Finisher, Flatwork, Machine	10.83***
16090 - Presser, Hand	10.83***
16110 - Presser, Machine, Drycleaning	10.83***
16130 - Presser, Machine, Shirts	10.83***
16160 - Presser, Machine, Wearing Apparel, Laundry	10.83***
16190 - Sewing Machine Operator	12.88***
16220 - Tailor	13.40***
16250 - Washer, Machine	11.34***
19000 - Machine Tool Operation And Repair Occupations	
19010 - Machine-Tool Operator (Tool Room)	19.46
19040 - Tool And Die Maker	24.46
21000 - Materials Handling And Packing Occupations	
21020 - Forklift Operator	15.36***
21030 - Material Coordinator	22.97
21040 - Material Expediter	22.97
21050 - Material Handling Laborer	12.57***
21071 - Order Filler	10.62***
21080 - Production Line Worker (Food Processing)	15.36***
21110 - Shipping Packer	17.12
21130 - Shipping/Receiving Clerk	17.12
21140 - Store Worker I	15.83***
21150 - Stock Clerk	22.26

GSWA PROCUREMENT RECORD Page 185

21210 - Tools And Parts Attendant	15.36***
21410 - Warehouse Specialist	15.36***
23000 - Mechanics And Maintenance And Repair Occupations	
23010 - Aerospace Structural Welder	25.04
23019 - Aircraft Logs and Records Technician	19.47
23021 - Aircraft Mechanic I	23.84
23022 - Aircraft Mechanic II	25.04
23023 - Aircraft Mechanic III	26.30
23040 - Aircraft Mechanic Helper	16.58
23050 - Aircraft, Painter	22.39
23060 - Aircraft Servicer	19.47
23070 - Aircraft Survival Flight Equipment Technician	22.39
23080 - Aircraft Worker	21.03
23091 - Aircrew Life Support Equipment (ALSE) Mechanic I	21.03
23092 - Aircrew Life Support Equipment (ALSE) Mechanic II	23.84
23110 - Appliance Mechanic	19.46
23120 - Bicycle Repairer	15.61***
23125 - Cable Splicer	22.47
23130 - Carpenter, Maintenance	17.58
23140 - Carpet Layer	18.20
23160 - Electrician, Maintenance	19.37
23181 - Electronics Technician Maintenance I	18.20
23182 - Electronics Technician Maintenance II	19.46
23183 - Electronics Technician Maintenance III	20.72
23260 - Fabric Worker	16.94
23290 - Fire Alarm System Mechanic	16.77
23310 - Fire Extinguisher Repairer	15.61***
23311 - Fuel Distribution System Mechanic	20.72
23312 - Fuel Distribution System Operator	15.61***
23370 - General Maintenance Worker	13.24***
23380 - Ground Support Equipment Mechanic	23.84
23381 - Ground Support Equipment Servicer	19.47
23382 - Ground Support Equipment Worker	21.03
23391 - Gunsmith I	15.61***
23392 - Gunsmith II	18.20
23393 - Gunsmith III	20.72
23410 - Heating, Ventilation And Air-Conditioning Mechanic	19.27
23411 - Heating, Ventilation And Air Contidioning Mechanic (Research Facility)	20.50
23430 - Heavy Equipment Mechanic	19.50
23440 - Heavy Equipment Operator	18.10
23460 - Instrument Mechanic	20.72
23465 - Laboratory/Shelter Mechanic	19.46
23470 - Laborer	12.57***
23510 - Locksmith	19.46
23530 - Machinery Maintenance Mechanic	23.13
23550 - Machinist, Maintenance	20.72
23580 - Maintenance Trades Helper	11.77***
23591 - Metrology Technician I	20.72
23592 - Metrology Technician II	22.03
23593 - Metrology Technician III	23.33
23640 - Millwright	20.72
23710 - Office Appliance Repairer	19.46
23760 - Painter, Maintenance	17.04
23790 - Pipefitter, Maintenance	19.96
23810 - Plumber, Maintenance	18.75
23820 - Pneudraulic Systems Mechanic	20.72
23850 - Rigger	20.72
23870 - Scale Mechanic	18.20
23890 - Sheet-Metal Worker, Maintenance	19.55
23910 - Small Engine Mechanic	18.20
23931 - Telecommunications Mechanic I	19.96
23932 - Telecommunications Mechanic II	21.24
23950 - Telephone Lineman	20.62
23960 - Welder, Combination, Maintenance	19.96
23965 - Well Driller	21.13
23970 - Woodcraft Worker	20.71
23980 - Woodworker	15.61***
24000 - Personal Needs Occupations	
24550 - Case Manager	15.01***
24570 - Child Care Attendant	10.09***
24580 - Child Care Center Clerk	13.25***
24610 - Chore Aide	14.06***
24620 - Family Readiness And Support Services Coordinator	15.01***
24630 - Homemaker	16.12***
25000 - Plant And System Operations Occupations	

GSWA PROCUREMENT RECORD Page 186

25010 - Boiler Tender	22.79
25040 - Sewage Plant Operator	22.89
25070 - Stationary Engineer	22.79
25190 - Ventilation Equipment Tender	15.72***
25210 - Water Treatment Plant Operator	22.89
27000 - Protective Service Occupations	
27004 - Alarm Monitor	10.90***
27007 - Baggage Inspector	9.63***
27008 - Corrections Officer	14.59***
27010 - Court Security Officer	14.59***
27030 - Detection Dog Handler	10.90***
27040 - Detention Officer	14.59***
27070 - Firefighter	14.59***
27101 - Guard I	9.63***
27102 - Guard II	10.90***
27131 - Police Officer I	14.59***
27132 - Police Officer II	16.21
28000 - Recreation Occupations	
28041 - Carnival Equipment Operator	13.24***
28042 - Carnival Equipment Repairer	14.46***
28043 - Carnival Worker	9.78***
28210 - Gate Attendant/Gate Tender	13.18***
28310 - Lifeguard	11.01***
28350 - Park Attendant (Aide)	14.74***
28510 - Recreation Aide/Health Facility Attendant	11.84***
28515 - Recreation Specialist	18.26
28630 - Sports Official	11.74***
28690 - Swimming Pool Operator	17.71
29000 - Stevedoring/Longshoremen Occupational Services	
29010 - Blocker And Bracer	26.02
29020 - Hatch Tender	26.02
29030 - Line Handler	26.02
29041 - Stevedore I	24.21
29042 - Stevedore II	27.82
30000 - Technical Occupations	
30010 - Air Traffic Control Specialist, Center (HFO) (see 2)	43.06
30011 - Air Traffic Control Specialist, Station (HFO) (see 2)	29.69
30012 - Air Traffic Control Specialist, Terminal (HFO) (see 2)	32.70
30021 - Archeological Technician I	18.17
30022 - Archeological Technician II	20.33
30023 - Archeological Technician III	25.19
30030 - Cartographic Technician	25.19
30040 - Civil Engineering Technician	25.19
30051 - Cryogenic Technician I	27.89
30052 - Cryogenic Technician II	30.80
30061 - Drafter/CAD Operator I	18.17
30062 - Drafter/CAD Operator II	20.33
30063 - Drafter/CAD Operator III	22.66
30064 - Drafter/CAD Operator IV	27.89
30081 - Engineering Technician I	16.19***
30082 - Engineering Technician II	18.17
30083 - Engineering Technician III	20.33
30084 - Engineering Technician IV	25.19
30085 - Engineering Technician V	30.80
30086 - Engineering Technician VI	37.27
30090 - Environmental Technician	25.19
30095 - Evidence Control Specialist	25.19
30210 - Laboratory Technician	22.66
30221 - Latent Fingerprint Technician I	27.89
30222 - Latent Fingerprint Technician II	30.80
30240 - Mathematical Technician	25.19
30361 - Paralegal/Legal Assistant I	19.54
30362 - Paralegal/Legal Assistant II	24.21
30363 - Paralegal/Legal Assistant III	29.61
30364 - Paralegal/Legal Assistant IV	35.83
30375 - Petroleum Supply Specialist	30.80
30390 - Photo-Optics Technician	24.92
30395 - Radiation Control Technician	30.80
30461 - Technical Writer I	25.19
30462 - Technical Writer II	30.80
30463 - Technical Writer III	37.27
30491 - Unexploded Ordnance (UXO) Technician I	27.37
30492 - Unexploded Ordnance (UXO) Technician II	33.11
30493 - Unexploded Ordnance (UXO) Technician III	39.69
30494 - Unexploded (UXO) Safety Escort	27.37
30495 - Unexploded (UXO) Sweep Personnel	27.37
30501 - Weather Forecaster I	27.89
30502 - Weather Forecaster II	33.93
30620 - Weather Observer, Combined Upper Air Or Surface Programs (see 2)	22.66

GSWA PROCUREMENT RECORD Page 187

30621 - Weather Observer, Senior	(see 2)	25.19
31000 - Transportation/Mobile Equipment Operation Occupations		
31010 - Airplane Pilot		33.11
31020 - Bus Aide		8.97***
31030 - Bus Driver		11.73***
31043 - Driver Courier		10.26***
31260 - Parking and Lot Attendant		9.91***
31290 - Shuttle Bus Driver		11.65***
31310 - Taxi Driver		11.41***
31361 - Truckdriver, Light		11.21***
31362 - Truckdriver, Medium		12.16***
31363 - Truckdriver, Heavy		16.11***
31364 - Truckdriver, Tractor-Trailer		16.11***
99000 - Miscellaneous Occupations		
99020 - Cabin Safety Specialist		16.14***
99030 - Cashier		10.01***
99050 - Desk Clerk		9.71***
99095 - Embalmer		27.37
99130 - Flight Follower		27.37
99251 - Laboratory Animal Caretaker I		24.31
99252 - Laboratory Animal Caretaker II		26.56
99260 - Marketing Analyst		21.54
99310 - Mortician		27.37
99410 - Pest Controller		16.07***
99510 - Photofinishing Worker		14.38***
99710 - Recycling Laborer		17.32
99711 - Recycling Specialist		23.38
99730 - Refuse Collector		16.40
99810 - Sales Clerk		10.63***
99820 - School Crossing Guard		17.96
99830 - Survey Party Chief		23.99
99831 - Surveying Aide		13.65***
99832 - Surveying Technician		17.73
99840 - Vending Machine Attendant		24.31
99841 - Vending Machine Repairer		30.96
99842 - Vending Machine Repairer Helper		24.31

Joh

***Workers in this classification may be entitled to a higher minimum wage under Executive Order 14026 (\$16.20 per hour). Please see the Note at the top of the wage determination for more information. Please also note that the minimum wage requirements of Executive Order 14026 are not currently being enforced as to contracts or contract-like instruments entered into with the federal government in connection with seasonal recreational services or seasonal recreational equipment rental for the general public on federal lands.

ALL OCCUPATIONS LISTED ABOVE RECEIVE THE FOLLOWING BENEFITS:

HEALTH & WELFARE: \$4.98 per hour, up to 40 hours per week, or \$199.20 per week or \$863.20 per month

HEALTH & WELFARE EO 13706: \$4.57 per hour, up to 40 hours per week, or \$182.80 per week, or \$792.13 per month*

*This rate is to be used only when compensating employees for performance on an SCA-covered contract also covered by EO 13706, Establishing Paid Sick Leave for Federal Contractors. A contractor may not receive credit toward its SCA obligations for any paid sick leave provided pursuant to EO 13706.

VACATION: 2 weeks paid vacation after 1 year of service with a contractor or successor; and 4 weeks after 3 years. Length of service includes the whole span of continuous service with the present contractor or successor, wherever employed, and with the predecessor contractors in the performance of similar work at the same Federal facility. (Reg. 29 CFR 4.173)

HOLIDAYS: A minimum of eleven paid holidays per year: New Year's Day, Martin Luther King Jr.'s Birthday, Washington's Birthday, Memorial Day, Juneteenth National Independence Day, Independence Day, Labor Day, Columbus Day, Veterans' Day, Thanksgiving Day, and Christmas Day. (A contractor may substitute for any of the named holidays another day off with pay in accordance with a plan communicated to the employees involved.) (See 29 CFR 4.174)

THE OCCUPATIONS WHICH HAVE NUMBERED FOOTNOTES IN PARENTHESES RECEIVE THE FOLLOWING:

1) **COMPUTER EMPLOYEES:** This wage determination does not apply to any individual employed in a bona fide executive, administrative, or professional capacity, as defined in 29 C.F.R. Part 541. (See 41 C.F.R. 6701(3)). Because most Computer Systems Analysts and Computer Programmers who are paid at least \$27.63 per hour (or at least \$684 per week if paid on a salary or fee basis) likely qualify as exempt computer professionals under 29 U.S.C. 213(a)(1) and 29 U.S.C. 213(a)(17), this wage determination may not include wage rates for all occupations within those job families. In such instances, a conformance will be necessary if there are nonexempt employees in these job families working on the contract.

Job titles vary widely and change quickly in the computer industry, and are not determinative of whether an employee is an exempt computer professional. To be exempt, computer employees who satisfy the compensation requirements must also have a primary duty that consists of:

(1) The application of systems analysis techniques and procedures, including consulting with users, to determine hardware, software or system functional specifications;

(2) The design, development, documentation, analysis, creation, testing or modification of computer systems or programs, including prototypes, based on and related to user or system design specifications;

(3) The design, documentation, testing, creation or modification of computer programs related to machine operating systems; or

(4) A combination of the aforementioned duties, the performance of which requires the same level of skills. (29 C.F.R. 541.400).

Any computer employee who meets the applicable compensation requirements and the above duties test qualifies as an exempt computer professional under both section 13(a)(1) and section 13(a)(17) of the Fair Labor Standards Act. (Field Assistance Bulletin No. 2006-3 (Dec. 14, 2006)). Accordingly, this wage determination will not apply to any exempt computer employee regardless of which of these two exemptions is utilized.

2) **AIR TRAFFIC CONTROLLERS AND WEATHER OBSERVERS - NIGHT PAY & SUNDAY PAY:** If you work at night as part of a regular tour of duty, you will earn a night differential and receive an additional 10% of basic pay for any hours worked between 6pm and 6am. If you are a full-time employed (40 hours a week) and Sunday is part of your regularly scheduled workweek, you are paid at your rate of basic pay plus a Sunday premium of 25% of your basic rate for each hour of Sunday work which is not overtime (i.e. occasional work on Sunday outside the normal tour of duty is considered overtime work).

**** HAZARDOUS PAY DIFFERENTIAL ****

An 8 percent differential is applicable to employees employed in a position that represents a high degree of hazard when working with or in close proximity to ordnance, explosives, and incendiary materials. This includes work such as screening, blending, dying, mixing, and pressing of sensitive ordnance, explosives, and pyrotechnic compositions such as lead azide, black powder and photoflash powder. All dry-house activities involving propellants or explosives. Demilitarization, modification, renovation, demolition, and maintenance operations on sensitive ordnance, explosives and incendiary materials. All operations involving re-grading and cleaning of artillery ranges.

A 4 percent differential is applicable to employees employed in a position that represents a low degree of hazard when working with, or in close proximity to ordnance, (or employees possibly adjacent to) explosives and incendiary materials which involves potential injury such as laceration of hands, face, or arms of the employee engaged in the operation, irritation of the skin, minor burns and the like; minimal damage to immediate or adjacent work area or equipment being used. All operations involving, unloading, storage, and hauling of ordnance, explosive, and incendiary ordnance material other than small arms ammunition. These differentials are only applicable to work that has been specifically designated by the agency for ordnance, explosives, and incendiary material differential pay.

**** UNIFORM ALLOWANCE ****

If employees are required to wear uniforms in the performance of this contract (either by the terms of the Government contract, by the employer, by the state or local law, etc.), the cost of furnishing such uniforms and maintaining (by laundering or dry cleaning) such uniforms is an expense that may not be borne by an employee where such cost reduces the hourly rate below that required by the wage determination. The Department of Labor will accept payment in accordance with the following standards as compliance:

The contractor or subcontractor is required to furnish all employees with an adequate number of uniforms without cost or to reimburse employees for the actual cost of the uniforms. In addition, where uniform cleaning and maintenance is made the responsibility of the employee, all contractors and subcontractors subject to this wage determination shall (in the absence of a bona fide collective bargaining agreement providing for a different amount, or the furnishing of contrary affirmative proof as to the actual cost), reimburse all employees for such cleaning and maintenance at a rate of \$3.35 per week (or \$.67 cents per day). However, in those instances where the uniforms furnished are made of "wash and wear" materials, may be routinely washed and dried with other personal garments, and do not require any special treatment such as dry cleaning, daily washing, or commercial laundering in order to meet the cleanliness or appearance standards set by the terms of the Government contract, by the contractor, by law, or by the nature of the work, there is no requirement that employees be reimbursed for uniform maintenance costs.

**** SERVICE CONTRACT ACT DIRECTORY OF OCCUPATIONS ****

The duties of employees under job titles listed are those described in the "Service Contract Act Directory of Occupations", Fifth Edition (Revision 1), dated September 2015, unless otherwise indicated.

**** REQUEST FOR AUTHORIZATION OF ADDITIONAL CLASSIFICATION AND WAGE RATE, Standard Form 1444 (SF-1444) ****

Conformance Process:

The contracting officer shall require that any class of service employee which is not listed herein and which is to be employed under the contract (i.e., the work to be performed is not performed by any classification listed in the wage determination), be classified by the contractor so as to provide a reasonable relationship (i.e., appropriate level of skill comparison) between such unlisted classifications and the classifications listed in the wage determination (See 29 CFR 4.6(b)(2)(i)). Such conforming procedures shall be initiated by the contractor prior to the performance of contract work by such unlisted class(es) of employees (See 29 CFR 4.6(b)(2)(ii)). The Wage and Hour Division shall make a final determination of conformed classification, wage rate, and/or fringe benefits which shall be paid to all employees performing in the classification from the first day of work on which contract work is performed by them in the classification. Failure to pay such unlisted employees the compensation agreed upon by the interested parties and/or fully determined by the Wage and Hour Division retroactive to the date such class of employees commenced contract work shall be a violation of the Act and this contract. (See 29 CFR 4.6(b)(2)(v)). When multiple wage determinations are included in a contract, a separate SF-1444 should be prepared for each wage determination to which a class(es) is to be conformed.

The process for preparing a conformance request is as follows:

- 1) When preparing the bid, the contractor identifies the need for a conformed occupation(s) and computes a proposed rate(s).
- 2) After contract award, the contractor prepares a written report listing in order the proposed classification title(s), a Federal grade equivalency (FGE) for each proposed classification(s), job description(s), and rationale for proposed wage rate(s), including information regarding the agreement or disagreement of the authorized representative of the employees involved, or where there is no authorized representative, the employees themselves. This report should be submitted to the contracting officer no later than 30 days after such unlisted class(es) of employees performs any contract work.
- 3) The contracting officer reviews the proposed action and promptly submits a report of the action, together with the agency's recommendations and pertinent information including the position of the contractor and the employees, to the U.S. Department of Labor, Wage and Hour Division, for review (See 29 CFR 4.6(b)(2)(ii)).
- 4) Within 30 days of receipt, the Wage and Hour Division approves, modifies, or disapproves the action via transmittal to the agency contracting officer, or notifies the contracting officer that additional time will be required to process the request.
- 5) The contracting officer transmits the Wage and Hour Division's decision to the contractor.
- 6) Each affected employee shall be furnished by the contractor with a written copy of such determination or it shall be posted as a part of the wage determination (See 29 CFR 4.6(b)(2)(iii)).

Information required by the Regulations must be submitted on SF-1444 or bond paper.

When preparing a conformance request, the "Service Contract Act Directory of Occupations" should be used to compare job definitions to ensure that duties requested are not performed by a classification already listed in the wage determination. Remember, it is not the job title, but the required tasks that determine whether a class is included in an established wage determination. Conformances may not be used to artificially split, combine, or subdivide classifications listed in the wage determination (See 29 CFR 4.152(c)(1))."

AFFIDAVIT re CONTINGENT FEES

CITY OF Hagatna)
) ss.
ISLAND OF GUAM)

John Alexius Lintiaco Jr. [state name of affiant signing below], being first duly sworn, deposes and says that:

1. The name of the offering company or individual is [state name of company] Far East Equipment Company, LLC

2. As a part of the offering company's bid or proposal, to the best of my knowledge, the offering company has not retained any person or agency on a percentage, commission, or other contingent arrangement to secure this contract. This statement is made pursuant to 2 GAR Division 4 11108(f).

3. As a part of the offering company's bid or proposal, to the best of my knowledge, the offering company has not retained a person to solicit or secure a contract with the government of Guam upon an agreement or understanding for a commission, percentage, brokerage, or contingent fee, except for retention of bona fide employees or bona fide established commercial selling agencies for the purpose of securing business. This statement is made pursuant to 2 GAR Division 4 11108(h).

4. I make these statements on behalf of myself as a representative of the offeror, and on behalf of the offeror's officers, representatives, agents, subcontractors, and employees.

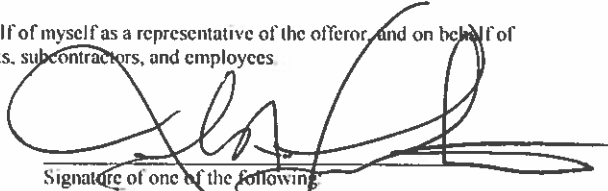

Signature of one of the following:
Offeror, if the offeror is an individual.
Partner, if the offeror is a partnership.
Officer, if the offeror is a corporation.

Subscribed and sworn to before me

this 17th day of November, 2023



NOTARY PUBLIC
My commission expires November 03, 2025

RENEE ANN C. WADE
NOTARY PUBLIC
In and for the Territory of Guam, U.S.A.
My Commission Expires: **NOV. 03, 2025**
111 Chalan Santo Papa Hagåtña, Guam 96910



CERTIFICATION OF NON-EMPLOYMENT OF CONVICTED SEXUAL OFFENDERS

Pursuant to Guam Public Law 28-24, as amended by Guam Public Law 28-98, if a contract for services is awarded to an Offeror, then the service provider must warrant that no person in its employment who has been convicted of a sex offense under the provisions of Chapter 25 of Title 9 of the Guam Code Annotated or of an offense defined in Article 2 of Chapter 28 of Title 9 of the Guam Code Annotated, or who has been convicted in any other jurisdiction of an offense with the same elements as heretofore defined, or who is listed on the Sex Offender Registry, shall provide services on behalf of the service provider while on government of Guam property, with the exception of public highways. If any employee of a service provider is providing services on government property and is convicted subsequent to an award of a contract, then the service provider warrants that it will notify the GSWA of the conviction within twenty-four hours of the conviction and will immediately remove such convicted person from providing services on government of Guam property. If the service provider is found to be in violation of any of the provisions of this paragraph, then the GSWA will give notice to the service provider to take corrective action. The service provider shall take corrective action within twenty-four hours of notice from the GSWA, and the service provider shall notify the GSWA when action has been taken. If the service provider fails to take corrective steps within twenty-four hours of notice from the GSWA, then the GSWA in its sole discretion may suspend temporarily any contract for services.

I, John Alexius Limtiaco Jr. being a duly authorized representative of the Offeror,
(print name)

acknowledge the requirements described above, have ensured that the Proposal as submitted addresses these requirements, and certify that if awarded the contract, the Offeror will follow these mandates.

Far East Equipment Company, LLC
(Company Name)

President
(Title)

[Handwritten Signature]
(Signature)

(Date)



GUAM SOLID WASTE AUTHORITY
546 NORTH MARINE CORPS DRIVE TAMUNING, GUAM 96913
TEL: (671) 646-3111 | FAX: (671) 649-3777
WWW.GUAMSOLIDWASTEAUTHORITY.COM

BID BOND

NO. _____

KNOW ALL MEN BY THESE PRESENTS that _____, as Principal Hereinafter called the Principal, and (Bonding Company), _____ A duly admitted insurer under the laws of the Territory of Guam, Surety, hereinafter called the Surety are held firmly bound unto the Territory of Guam for the sum of _____ Dollars (\$ _____), for Payment of which sum will and truly to be made, the said Principal and the said Surety bind ourselves, our heirs, executors, administrators, successors and assigns, jointly and severally, firmly by these presents.

WHEREAS, the Principal has submitted a bid for (identify project by number and brief description)

NOW, THEREFORE, if the Territory of Guam shall accept the bid of the Principal and the Principal shall enter into a contract with the Territory of Guam in accordance with the terms of such bid, and give such bond or bonds as may be specified in bidding or Contract Documents with good and sufficient surety for the faithful performance of such Contract and for the prompt payment of labor and material furnished in the prosecution thereof, or in the event of the failure of the Principal to enter such Contract and give such bond or bonds, if the Principal shall pay to the Territory of Guam the difference not to exceed the penalty hereof between the amounts specified in said bid and such larger amount for which the Territory of Guam may in good faith contract with another part to perform work covered by said bid or an appropriate liquidated amount as specified in the Invitation for Bids then this obligation shall be null and void, otherwise to remain full force and effect.

Signed and sealed this _____ day of _____ 20_____.

(PRINCIPAL)

(SEAL)

(WITNESS)

(TITLE)

(MAJOR OFFICER OF SURETY)

(TITLE)

(MAJOR OFFICER OF SURETY)

(TITLE)

(RESIDENTIAL GENERAL AGENT)

SEE INSTRUCTIONS IN BACK PAGE FOR SUPPORTING DOCUMENTS REQUIRED.



Headquarters

P.O. Box BW Hagåtña, Guam 96932

Tel: (671) 472-5300

Member FDIC

December 4, 2023

LC No.: 01-SB-1947

Dated: December 4, 2023

Amount: \$38,000.00

Guam Solid Waste Authority
546 N. Marine Corp Drive
Tamuning, Guam 96913

Applicant: Far East Equipment Company, LLC.
17-3311 Corsair Road Tiyan
Barrigada, Guam 96913

Beneficiary: Guam Solid Waste Authority
546 N. Marine Corp Drive
Tamuning, Guam 96913

To Guam Solid Waste Authority:

We hereby enclose our Irrevocable Standby Letter of Credit no. 01-SB-1947 dated December 4, 2023 in the amount of \$38,000.00 in your favor for the account of Far East Equipment Company, LLC.

Please contact us should you have any questions.

Sincerely,
BANK OF GUAM



Ramona Toves
Credits Officer

ramona.toves@bankofguam.com

Phone: (671) 472-5152



Bank of Guam®

Tel: (671) 472-5300

Headquarters • 111 Chalan Santo Papa, Hagåtña, Guam 96910

LETTER OF CREDIT Irrevocable Standby

Date December 4, 2023

Letter of Credit No. 01-SB-1947

Amount \$38,000.00

Expiration Date March 4, 2024

APPLICANT:

Far East Equipment Company, LLC.
17-3311 Corsair Road Tiyan
Barrigada, Guam 96913

BENEFICIARY:

Guam Solid Waste Authority
546 N. Marine Corp Drive
Tamuning, Guam 96913

To Guam Solid Waste Authority:

We hereby establish our Irrevocable Standby Letter of Credit No. 01-SB-1947 in your favor for the account of Far East Equipment Company, LLC., 17-3311 Corsair Road Tiyan, Barrigada, Guam 96913 up to the aggregated amount of \$38,000.00 (Thirty-eight Thousand and no/100) available by your drafts drawn at SIGHT on Bank of Guam, 111 Chalan Santo Papa, Hagatna, Guam 96910 and accompanied by documents specified as follows:

- 1) Beneficiary's signed certificate stating that the applicant has defaulted on the terms and conditions set forth under Invitation for Bid No. GSWA-004-24 for Compact Wheel Loader w/ Attachments.
- 2) The original Letter of Credit and all Amendments, if any.

Partial drawings under this credit are not allowed.

We hereby agree with you that all drafts drawn under and in compliance with the terms of this credit shall be met with due honor upon presentation and delivery of documents as specified to the drawee if drawn and presented for negotiation on or before March 4, 2024.

All documents are to be marked with Bank of Guam reference no. 01-SB-1947 and are to be forwarded to Bank of Guam, Headquarters, Attn: Letters of Credit Department, 111 Chalan Santo Papa, Hagatna, Guam 96910.

***** E N D *****

Sincerely,
BANK OF GUAM

BY
Authorized Signer: Janine Eustaquio - VP/Credit Officer

BY
Authorized Signer: Ramona Toves - PAC/Credit Officer

PROVISIONS APPLICABLE TO THIS CREDIT: This credit is subject to the Uniform Customs and Practice for Documentary Credits (2007 Provision) International Chamber of Commerce Publication No. 600.

INSTRUCTION TO PROVIDERS:

NOTICE to all Insurance and Bonding Institutions:

The Bond requires the signatures of the Vendor, two (2) major Officers of the Surety and Resident General Agent, if the Surety is a foreigner or alien surety.

When the form is submitted to the Guam Solid Waste Authority, it should be accompanied with copies of the following:

1. Current Certificate of Authority to do business on Guam Issued by the Department of Revenue and Taxation.
2. Power Of Attorney issued by the Surety to the Resident General Agent.
3. Power of Attorney issued by two (2) major officers of the Surety to whoever is signing on their behalf.

Bonds, submitted as Bid Guarantee, without signatures and supporting documents are invalid and Bids will be rejected.



DEPARTMENT OF REVENUE AND TAXATION

GOVERNMENT OF GUAM

P.O. Box 23607

Barrigada, Guam 96921

www.guamtax.com

BUSINESS LICENSE

SERIAL # 2410961

Ltd Liability Company

EXPIRES: June 30, 2024

Service

ACCOUNT NO. 13-200600764-01

R

ISSUED TO:

FAR EAST EQUIPMENT COMPANY, LLC

FEE 50 00

DOING BUSINESS AS:

FAR EAST EQUIPMENT COMPANY, LLC

PENALTY 0 00

TYPE OF LICENSE:

REPAIR OF AUTOMOTIVES TRUCKS BUSES HEAVY
& INDUSTRIAL EQUIPMENTS

TOTAL FEE 50 00

BUSINESS LOCATION:

#17-3311 CORSAIR RD

TIYAN BARRIGADA GUAM

MAILING ADDRESS:

P O BOX 10838

TAMUNING GUAM

TELEPHONE: HOME

96931

BUSINESS 888-6270

06/29/2023

KEEP POSTED IN A CONSPICUOUS PLACE.
LICENSE MUST BE PRODUCED UPON
DEMAND TO ANY AUTHORIZED GOVT
OFFICIAL.

DIRECTOR OF REVENUE AND TAXATION

Dafne Mansapit-Snimizu





DEPARTMENT OF REVENUE AND TAXATION

GOVERNMENT OF GUAM

P.O. Box 23607
Barrigada, Guam 96921
www.guamlax.com

BUSINESS LICENSE

SERIAL # 2410964

Ltd Liability Company

Retail

R

EXPIRES: June 30, 2024

ACCOUNT NO. 30-200600764-01

FEE	1,000 00
PENALTY	0 00
TOTAL FEE	1,000 00

ISSUED TO: FAR EAST EQUIPMENT COMPANY, LLC

DOING BUSINESS AS: FAR EAST EQUIPMENT COMPANY, LLC

TYPE OF LICENSE: SALE OF AUTOMOTIVES TRUCKS BUSES HEAVY

& INDUSTRIAL EQUIPMENTS

BUSINESS LOCATION: #17-3311 CORSAIR RD

TIYAN BARRIGADA GUAM

MAILING ADDRESS: P O BOX 10838

TAMUNING GUAM

TELEPHONE: HOME

96931

BUSINESS 888-6270

06/29/2023

**KEEP POSTED IN A CONSPICUOUS PLACE.
LICENSE MUST BE PRODUCED UPON
DEMAND TO ANY AUTHORIZED GOV'T
OFFICIAL.**

DIRECTOR OF REVENUE AND TAXATION

Dafne Mansapit-Shimizu



GOVERNMENT OF GUAM

GENERAL TERMS AND CONDITIONS

SEALED BID SOLICITATION AND AWARD

ONLY THOSE BOXES CHECKED BELOW ARE APPLICABLE TO THIS BID

1. **AUTHORITY:**

This solicitation is issued subject to all the provisions of the Guam Procurement Act (5GCA, Chapter 5) and the Guam Procurement Regulations (copies of both are available at the Office of the Comptroller of Laws, Department of Law, copies available for inspection at the Guam Solid Waste Authority). It requires all parties involved in the Preparation, negotiation, performance, or administration of contracts to act in good faith.

2. **GENERAL INTENTION:** Unless otherwise specified, these General Terms and conditions are intended for the bidder to provide the Government of Guam (Government) with specified services or with materials, supplies or equipment completely assembled and ready for use.

3. **TAXES:** Bidders are cautioned that they are subject to Guam Income Taxes as well as all other taxes on Guam transactions. Specific information on taxes may be obtained from the Director of Revenue and Taxation.

4. **LICENSING:** Bidders are cautioned that the Government will not consider for award any offer submitted by a bidder who has not complied with the Guam Licensing law. Specific information on licenses may be obtained from the Director of Revenue and Taxation.

5. **LOCAL PROCUREMENT PREFERENCE:** All procurement of supplies and services where possible, will be made from among businesses licensed to do business on Guam in accordance with section 5008 of the Guam Procurement Act (5GCA, Chapter 5) and Section 1104 of the Guam Procurement Regulations.

6. **COMPLIANCE WITH SPECIFICATIONS AND OTHER SOLICITATION REQUIREMENTS:** Bidders shall comply with all specifications and other requirements of the Solicitation.

7. **"ALL OR NONE" BIDS:** Unless otherwise allowed under this Solicitation, "all or none" bids may be deemed to be non-responsive. If the bid is so limited, the Government may reject part of such proposal and award on the remainder.

NOTE: By checking this item, The Government is requesting all of the bid items to be items to be bid or none at all. The Government will not award on an itemized basis. Reference 3-101.06 of the Guam Procurement Regulations.

8. **INDEPENDENT PRICE DETERMINATION:** The bidder, upon signing the Invitation for Bid, certifies that the prices in his bid were derived without collusion, and acknowledges that collusion and anti-competitive practices are prohibited by law. Violations will be subject to the provision of Section 5651 of that of the Guam Procurement Act. Other existing civil, criminal or administrative remedies are not impaired and may be in addition to the remedies in Section 5651 of the Government code. By submitting a bid, the bidder certifies that its price was independently arrived at without collusion.

9. **BIDDER'S PRICE:** The Government will consider not more than two (2) (basic and Alternate) item prices and the bidder shall explain fully each price if supplies, materials, equipment, and/or specified services offered comply with specifications and the products origin. Where basic or alternate bid meets the minimum required specification, cost and other factors will be considered. Failure to explain this requirement will result in rejection of the bid.

10. **BID ENVELOPE:** Envelope shall be sealed and marked with the Bidder's name, Bid number, time, date and place of Bid opening.

11. **BID GUARANTEE REQUIREMENT:** Bidder is required to submit a Bid Guarantee Bond or standby irrevocable Letter of Credit or Certified Check or Cashier's Check in the same bid envelope to be held by the Government pending delivery of items being procured. The Bid Guarantee Bond, Letter of Credit, Certified Check or cashier's check must be issued by any local surety or banking institution licensed to do business on Guam and made payable to the Guam Solid Waste Authority in the amount of fifteen percent (15%) of the total bid offer. The Bid Bond must be submitted on Government Standard Form BB-1 (copy enclosed). Personal Checks will not be accepted as Bid Guarantee. If a successful Bidder (contractor) withdraws from the bid or fails to enter into contract within the prescribed time, such Bid guarantee will be forfeited to the Government of Guam. Bids will be disqualified if not accompanied by Bid Bond, Letter of Credit, Certified Check or Cashier's Check. Bidder must include in his/her bid, valid copies of a Power of Attorney from the Surety and a Certificate of Authority from the Government of Guam to show proof that the surety company named on the bond instrument is authorized by the Government of Guam to be qualified to do business on Guam. For detailed information on bonding matters, contact the Department of Revenue and Taxation. Failure to submit a valid Power of Attorney and Certificate of Authority on the surety is cause for rejection of bid. (GPR Section 3109(c)(3)) Pursuant to 5 GCA Section 5212, all competitive sealed bidding for the procurement of supplies or services exceeding \$25,000 must be accompanied by bid security in the amount of 15% of the total bid price.

12. **PERFORMANCE GUARANTEE:** Bidders, who are awarded a contract under this solicitation, guarantee that goods will be delivered or required services performed within the time specified. Failure to perform the contract in a satisfactory manner may be cause for suspension or debarment from doing business with the Government and for enforcement of Section 23 of these General terms and Conditions. In addition, the Government will hold the Vendor liable and will enforce the requirements as set forth in Section 41 of these General Terms and Conditions.

13. **SURETY BONDS:** Bid and Performance Bonds coverage must be signed or countersigned in Guam by a foreign or alien surety's resident general agent. The Surety must be an Insurance Company, authorized by the Government of Guam and qualified to do business in Guam. Bids will be disqualified if the Surety Company does not have a valid Certificate of Authority from the Government of Guam to conduct business in Guam.

14. **COMPETENCY OF BIDDERS:** Bids will be considered only from the such bidders who, in the opinion of the Government, can show evidence of their ability, experience, equipment, and facilities to render satisfactory service.

15. **DETERMINATION OF RESPONSIBILITY OF BIDDERS:** The Guam Solid Waste Authority reserves the right for securing from bidders information to determine whether or not they are responsible and to inspect plant site, place of business, and supplies and services as necessary to determine their responsibility in accordance with Section 15 of these General Terms and Conditions (GPR Section 3-401).

16. **STANDARD FOR DETERMINATION OF LOWEST RESPONSIBLE BIDDER:** In determining the lowest responsible offer, the Guam Solid Waste Authority shall be guided by the following:

- a) Price of Items offered.
- b) The ability, capacity, and skill of the Bidder to perform.
- c) Whether the bidder can perform promptly within the specified time.
- d) The quality of performance of the Bidder with regards to awards previously made to him.
- e) The previous and existing compliance by the Bidder with laws and regulations relative to procurement.
- f) The sufficiency of the financial resources and ability of the Bidder to perform.
- g) The ability of the bidder to provide future maintenance and services for the subject of the award.
- h) The compliance with all of the conditions to the Solicitation.

17. **TIE BIDS:** If the bids are for the same unit price or total amount in the whole or in part, the Chief Procurement Officer will determine award based on 2 GAR, Div. 4, § 3109(o) (2) or to reject all such bids.

18. **BRAND NAMES:** Any reference in the Solicitation to manufacturer's Brand Names and number is due to lack of a satisfactory specification of commodity description. Such preference is intended to be descriptive, but not restrictive and for the sole purpose of indicating to prospective bidders a description of the article or services that will be satisfactory. Bids on comparable items will be considered provided the bidder clearly states in his bid the exact articles he is offering and how it differs from the original specification.

19. **CONTRACT AWARD:** In accordance with 5 GCA § 5211(g) and 2 GARR § 3109(n), after bids are publicly opened, an award will be made with reasonable promptness by written notice to the lowest responsible and responsive bidder whose bid meets the requirements and criteria set forth in the Invitation for Bids. The award will be made by

- Purchase Order
- Standard Form Contract

20. **DESCRIPTIVE LITERATURE:** Descriptive literature(s) as specified in this solicitation must be furnished as a part of the bid and must be received at the date and time set for the opening Bids. The literature furnished must clearly identify the item(s) in the Bid. The descriptive literature is required to establish for the purpose of evaluation and award details of the product(s) the bidder proposes to furnish including design, materials, components, performance characteristics, methods of manufacture, construction, assembly or other characteristics which are considered appropriate. Rejection of the Bid will be required if the descriptive literature(s) do not show that the product(s) offered conform(s) to the specifications and other requirements of this solicitation. Failure to furnish the descriptive literature(s) by the time specified in the Solicitation will require rejection of the bid.

21. **SAMPLES:** Sample(s) of the item(s) specified in this solicitation must be furnished as a part of the bid and must be received at the date and time set for opening Bids. The sample(s) should represent exactly what the bidder proposes to furnish and will be used to determine if the item(s) offered complies with the specifications. Rejection of the Bid will be required if the sample(s) do not show that the product(s) offered conform(s) to the specifications and other requirements of this solicitation. Failure to furnish the sample(s) by the time specified in the Solicitation will require rejection of the Bid.

22. **LABORATORY TEST:** Successful bidder is required to accompany delivery of his good with a Laboratory Test Report indicating that the product he is furnishing the Government meets with the specifications. This report is on the bidder's account and must be from a certified Testing Association.

23. **AWARD, CANCELLATION, & REJECTION:** Award shall be made to the lowest responsible bidder, whose bid is determined to be the most advantageous to the Government, taking into consideration the evaluation factors set forth in this solicitation. No other factors or criteria shall be used in the evaluation. The right is reserved as the interest of the Government may require to waive any minor irregularity in bid received. The Guam Solid Waste Authority shall have the authority to award, cancel, or reject bids, in whole or in part for any one or more items if he determines it is in the public interest. In case of an error in the extension of prices, unit price will govern. It is the policy of the Government to award contracts to qualified local bidders. The Government reserves the right to increase or decrease the quantity of the items for award and make additional awards for the same type of items and the vendor agrees to such modifications and additional awards based on the bid prices for a period of thirty (30) days after original award. No award shall be made under this solicitation which shall require advance payment or irrevocable letter of credit from the government (GPR Section 3-202.14.1)

24. **MARKING:** Each outside container shall be marked with the Purchase Order number, item number, brief item description and quantity. Letter marking shall not be less than ¾" in height.

25. **SCHEDULE FOR DELIVERY:** Successful bidder shall notify the Guam Solid Waste Authority, Telephone No. 647-4312 at least twenty-four (24) hours before delivery of any item under this solicitation.

26. **BILL OF SALE:** Successful supplier shall render Bills of Sale for each item delivered under this contract. Failure to comply with this requirement will result in rejection of delivery. The Bill of Sale must accompany the items delivered but will not be considered as an invoice for payment. Supplier shall bill the Government in accordance with billing instructions as indicated on the Purchase Order.

27. **MANUFACTURER'S CERTIFICATE:** Successful bidder is required, upon delivery of any item under this solicitation, to furnish a certificate from the manufacturer indicating that the goods meet the specifications. Failure to comply with this request will result in rejection of delivery or payment. Supplier shall bill the Government in accordance with billing instructions as indicated on the Purchase Order.

28. **INSPECTION:** All supplies, materials, equipment, or services delivered under this contract shall be subject to the inspection and/or test conducted by the Government at destination. If in any case the supplies, materials, equipment, or services are found to be

defective in material, workmanship, performance, or otherwise do not conform with the specifications, the Government shall have the right to reject the items or require that they be corrected. The number of days required for correction will be determined by the Government.

29. **MOTOR VEHICLE SAFETY REQUIREMENTS:** The Government will only consider Bids on motor vehicles which comply with the requirements of the National Traffic and Motor Vehicle safety Act of 1966 (Public Law 89-563) and Clean Air Act as amended (Public Law 88-206), that are applicable to Guam. Bidders shall state if the equipment offered comply with these aforementioned Federal Laws.

30. **SAFETY INSPECTIONS:** All motor vehicles delivered under this contract must pass the Government of Guam Vehicle Inspection before delivery at destination.

31. **GUARANTEE:**

a) **Guarantee of Vehicle Type of Equipment**

The successful bidder shall guarantee vehicular type of equipment offered against defective parts, workmanship, and performance, for a period of not less than one (1) year after date of receipt of equipment. Bidder shall also provide service to the equipment for at least one (1) year. Service to be provided shall include, but will not be limited to tune ups (change of spark plugs, contact points and condensers) and lubrication (change of engine and transmission oil). All parts and labor shall be at the expense of the bidder. All parts found defective and not caused by misuse, negligence or accident within the guarantee period shall be repaired, replaced, or adjusted within six (6) working days after notice from the Government and without cost to the Government. Vehicular type of equipment as used in this context shall include equipment used for transportation as differentiated from tractors, backhoes, etc.

b) **Guarantee of Other Type of Equipment:**

The successful bidder shall guarantee all other types of equipment offered, except those mentioned in 31a, above, against defective parts, workmanship, and performance for a period of not less than three (3) months after date of receipt of equipment. Bidder shall also provide service to the equipment for at least three (3) months. All parts found within that period shall be repaired or replaced by the Contractor without cost to the Government. Repairs, adjustments or replacements of defective parts shall be completed by the contractor within six (6) working days after notice from the Government.

(c) **Compliance with this Section is a condition of this Bid.**

32. **REPRESENTATION REGARDING ETHICS IN PUBLIC PROCUREMENT:** The bidder or contractor represents that it has not knowingly influenced and promises that will not knowingly influence a Government employee to breach any of the ethical standards and represents that it has not violated, is not violating, and promises that it will not violate the prohibition against gratuities and kickbacks set forth on Chapter 11 (Ethics in Public Contracting) of the Guam Procurement Act and in Chapter 11 of the Guam Procurement Regulations.

33. **REPRESENTATION REGARDING CONTINGENT FEES:** The contractor represents that it has not retained a person to solicit or secure a Government contract upon and agreement or understanding for a commission, percentage, brokerage, or contingent fee, except for retention of bona fide employees of bona fide established commercial selling agencies for the purpose of securing business (GPR Section 11-207).

34. **EQUAL EMPLOYMENT OPPORTUNITY:** Contractors shall not discriminate against any employee or applicant of employment because of race, color, religion, sex, or national origin. The contractor will take affirmative action to ensure that employees are treated equally during employment without regards to their race, color, religion, sex, or national origin.

35. **COMPLIANCE WITH LAWS:** Bidders awarded a contract under this Solicitation shall comply with the applicable standard, provisions, and stipulations of all pertinent Federal and/or local laws, rules, and regulations relative to the performance of this contract and the furnishing of goods.

36. **CHANGE ORDER:** Any order issued relative to awards made under this solicitation will be subject to and in accordance with the provisions of Section 6-101-03.1 of the Guam Procurement Regulations.

37. **STOP WORK ORDER:** Any stop work order issued relative to awards made under this solicitation will be subject to and in accordance with the provisions of Section 6-101-04.1 of the Guam Procurement Regulations.

38. **CANCELLATION OF INVITATION FOR BIDS OR REQUEST FOR PROPOSALS:** Any Invitation for Bid may be cancelled, or any or all bids or proposals may be rejected in whole or in part as may be specified in the solicitation, when it is in the best interests of the Territory in accordance with regulations promulgated by the Policy Office. The reasons therefor shall be made part of the contract file.

39. **TIME FOR COMPLETION:** It is hereby understood and mutually agreed by and between the contractor and the Government that the time for delivery to final destination or the timely performance of certain services is an essential condition of this contract. If the contractor refuses or fails to perform any of the provisions of this contract within the time specified in the Purchase Order (from the date Purchase Order is acknowledged by the vendor), then the contractor is in default. Defaults will be treated subject to and in accordance with the provisions of Section 6-101-08 of the Guam Procurement Regulations.

40. **JUSTIFICATION OF DELAY:** Bidders who are awarded contracts under this Solicitation, guarantee that the goods will be delivered to their destination or required services rendered within the time specified. If the bidder is not able to meet the specified delivery date, he is required to notify the Guam Solid Waste Authority of such delay. Notification shall be in writing and shall be received by the Guam Solid Waste Authority at least twenty-four (24) hours before the specified delivery date. Notification of delay shall include an explanation of the causes and reasons for the delay including statement(s) from supplier or shipping company causing the delay. The Government reserves the right to reject delay justification if, in the opinion of the Chief Procurement Officer, such justification is not adequate.

41. **SERVICE-DISABLED VETERAN OWNED BUSINESS PREFERENCE:** Bidding is subject to the policy in favor of Service-Disabled Veteran Owned Business as defined in 5 GCA sections 5011 and 5012.

42. **LIQUIDATED DAMAGES:** When the contractor is given notice of delay or nonperformance as specified in Paragraph 1 (Default) of the Termination for Default Clause of this contract and fails to cure in the time specified, the contractor shall be liable for

damages for delay in the amount of one-fourth of one percent (1%) of outstanding order per calendar day from date set for cure until either the territory reasonable obtains similar supplies or services if the contractor is terminated for default, or until the contractor provides the supplies or services if the contractor is not terminated for default. To the extent that the contractor's delay or non-performance is excused under Paragraph 15 (Excuse for Nonperformance or Delayed Performance) of the Termination for Default Clause of this contract, liquidated damages shall not be due the territory. The contractor remains liable for damages caused other than by delay. 2 GAR, Div. 4 §6101(d)

[x] 43. **PHYSICAL LIABILITY:** If it becomes necessary for the Vendor, either as principal, agent or employee, to enter upon the premises or property of the Government of Guam in order to construct, erect, inspect, make delivery or remove property hereunder, the Vendor hereby covenants and agrees to take, use, provide and make all proper, necessary and sufficient precautions, safeguards and protections against occurrence of any accidents, injuries or damages to any person or property during the progress of the work herein covered, and to be responsible for, and to indemnify and save harmless the Government of Guam from the payment of all sums of money by reason of all or any such accidents, injuries, or damages that may occur upon or about such work, and fines, penalties and loss incurred for or by reasons of the violations of any territorial ordinance, regulations, or the laws of Guam or the United States, while the work is in progress. Contractor will carry insurance to indemnify the Government of Guam against any claim for loss, damage or injury to property or persons arising out of the performance of the Contractor or its employees and agents of the services covered by the contract and the use, misuse or failure of any equipment used by the contractor or his employees or agents, and shall provide certificates of such insurance to the Government of Guam when required.

[x] 44. Contract will be cancelled if funds not appropriated or insufficient, and that government will timely inform contractor. 2 GAR, Div.4 §3121(e) (1) (C) and 2 GAR, Div. 4 §3121 (e)(1)(D).

[x] 45. **CONTACT FOR CONTRACT ADMINISTRATION:** If your firm receives a contract as a result of this Solicitation, Please designate a person whom we may contact for prompt administration.

Name: John Alexius Limtiaco Jr.

Title: President

Address: P.O. Box 10838
Tamuning, GU 96931

Telephone: 671-888-6270

SEALED BID SOLICITATION INSTRUCTIONS

1. **BID FORMS:** Each bidder shall be provided with two (2) sets of Solicitation forms. Additional copies may be provided upon request. Bidders requesting additional copies of said forms will be charged per page in accordance with Section 6114 of the Government Code of Guam. All payments for this purpose shall be by cash, certified check or money order and shall be made payable to the Guam Solid Waste Authority.
2. **PREPARATIONS OF BIDS:**
 - a. Bidders are required to examine the drawings, specifications, schedule, and all instructions. Failure to do so will be at bidder's risk.
 - b. Each bidder shall furnish the information required by the Solicitation. The bidder shall sign the solicitation and print or type his name on the Schedule. Erasures or other changes must be initialed by the person signing the bid. Bids signed by an agent are to be accompanied by evidence of this authority unless such evidence has been previously furnished to the issuing office.
 - c. Unit price for each unit offered shall be shown and such price shall include packing unless otherwise specified. A total shall be entered in the amount column of the Schedule for each item offered. In case of discrepancies between a unit price and extended price, the unit price will be presumed to be correct.
 - d. Bids for supplies or services other than those specified will not be considered. Time, if stated as a number of days, means calendar days and will include Saturdays, Sundays, and holidays beginning the day after the issuance of a Notice to Proceed. Time stated ending on Saturday, Sunday or Government of Guam legal holiday will end at the close of the next business day.
 - e. No Entitlement to Preparation Costs – the bidder expressly waives any right it may have against the government for any expenses incurred in connection with the preparation of its bid.
3. **EXPLANATION TO BIDDERS:** Any explanation desired by a bidder regarding the meaning or interpretation of the Solicitation, drawings, specifications, etc., must be submitted in writing and with sufficient time allowed for a written reply to reach all bidders before the submission of their bids. Oral explanations or instructions given before the award of the contract will not be binding. Any information given to a prospective bidder concerning a Solicitation will be furnished to all prospective bidders in writing as an amendment to the Solicitation if such information would be prejudicial to uninformed bidders.
4. **ACKNOWLEDGEMENT OF AMENDMENTS TO SOLICITATIONS:** Receipt of an amendment to a Solicitation by a bidder must be acknowledged by signing an acknowledgement of receipt of the amendment. Such acknowledgement must be received prior to the hour and date specified for receipt of bids.
5. **SUBMISSION OF BIDS:**
 - a. Bids and modifications thereof shall be enclosed in sealed envelopes and addressed to the office specified in the Solicitation. The bidder shall show the hour and date specified in the Solicitation for receipt, the Solicitation number, and the name and address of the bidder on the face of the envelope.
 - b. Electronic bids will not be considered unless authorized by the Solicitation. However, bids may be modified or withdrawn by written or electronic notice, provided such notice is received prior to the hour and date specified for receipt (see paragraph 6 of these instructions).
 - c. Samples of items, when required, must be submitted within the time specified, unless otherwise specified by the Government, at no expense to the Government. If not destroyed by testing, samples will be returned at bidder's request and expense, unless otherwise specified by the Solicitation.
 - d. Samples or descriptive literature should not be submitted unless it is required by this solicitation. Regardless of any attempt by a bidder to condition the bid, unsolicited samples or descriptive literature will not be examined or tested at the bidder's risk, and will not be deemed to vary any of the provisions of this Solicitation.
6. **FAILURE TO SUBMIT BID:** If no bid is to be submitted, do not return the solicitation documents unless otherwise specified. A letter or postcard shall be sent to the issuing office advising whether future Solicitations for the type of supplies or services covered by this Solicitation are desired.
7. **LATE BID, LATE WITHDRAWALS, AND LATE MODIFICATIONS:**
 - a. Definition: Any bid received after the time and date set for receipt of bids is late. Any withdrawal or modification of a bid received after the time and date set for opening of bids at the place designated for opening is late (Guam Procurement Regulations Section 3-202)
 - b. Treatment: No late bid, late modification, or late withdrawal will be considered unless received before contract award, and the bid, modification, or withdrawal would have been timely but for the action or inaction of territorial personnel directly serving the procurement activity.
9. **GOVERNMENT FURNISHED PROPERTY:** No material, labor or facilities will be furnished by the Government unless otherwise provided for in the Solicitation.
10. **CANCELLATION OR REVISION OF BID:** This IFB may be canceled, or any and all bids may be rejected in whole or in part as may be pursuant to GAR § 3115, when it is in the best interest of the Government. Additionally, in accordance with GAR § 9105, if prior to award it is determined that a solicitation or proposed award of a contract is in violation of the law, then the solicitation or proposed award shall be canceled or revised to comply with the law. The reasons therefore shall be made part of the contract file.
11. **REJECTION OF BIDS:** Any bidder submitted in response to this IFB may be rejected in whole or in part with it is in the best interest of the Government, in accordance with GAR § 3115(e). Reasons for rejecting bids include but are not limited to: (1) The business that submitted the bid is non-responsive as determined under GAR § 3116; (2) The bid ultimately fails to meet the announced requirements of the Government in some material respect; or (3) The bid price is clearly unreasonable. Upon request, successful bidders shall be advised of the reasons for rejection.

When bids are rejected, or a solicitation canceled after bids are received, the bids which have been opened shall be retained in the procurement file, or if unopened, returned to the bidders upon request, or otherwise disposed of pursuant to GAR § 3115(g).

- 12. TERMINATION OF CONTRACT: 1. TERMINATION OF CONVENIENCE PURSUANT TO GAR § 6101(10)**
- (a) **Termination:** The Government, when the interest of the Government so requires, may terminate this contract in whole or in part, for the Convenience of the Government. The Purchasing Agency shall give written notice of the termination to the contractor specifying the part of the contract terminated when termination becomes effective.
 - (b) **Contractor's Obligations:** The contractor shall incur no further obligations in connection with the terminated work and on the date set in the notice of termination the contractor will stop work to the extent specified.
 - (c) **Condition of Termination:** Notwithstanding the foregoing, the cessation of services for people requiring services shall be contingent upon the Government obtaining a substitute provider for the services and the contractor shall cooperate by taking all reasonable and necessary steps to ensure that services are not interrupted and transferred to the succeeding provider. The contractor shall issue a written memorandum detailing the status of the contractor's ongoing services initiating termination or any fault of either party.
- 13. SELLER'S INVOICES:** Invoices shall be prepared and submitted in quadruplicate (one copy shall be marked "original") unless otherwise specified. Invoices shall be "certified true and correct" and shall contain the following information: Contract and order number (if any), item numbers, description of supplies or services, sizes, quantities, unit prices, and extended total. Bill of lading number and weight of shipment will be shown for shipments made on Government bills of lading.
- 14. RECEIPT, OPENING AND RECORDING OF BIDS:** Bids and modifications shall be publicly opened in the presence of one or more witnesses, at the time, date, and place designated in the Invitation for Bids. The name of each bidder, the bid price, and such other information as is deemed appropriate by the Procurement Officer, shall be read aloud and recorded, or otherwise made available. The names and addresses of required witnesses shall be recorded at the opening. The opened bids shall be available for public inspection except to the extent the bidder designates trade secrets or other proprietary data to be confidential as set forth in accordance with Section 12, below. Material so designated shall accompany the bid and shall be readily separable from the bid in order to facilitate public inspection of the non-confidential portion of the bid. Prices, makes and models or catalogue numbers of the items offered, deliveries, and terms of payment shall be publicly available at the time of bid opening regardless of any designation to the contrary (Guam Procurement Regulations Section 3-202.12.2).
- 15. CONFIDENTIAL DATA:** The Procurement Officer shall examine the bids to determine the validity of any requests for nondisclosure of trade secrets and other proprietary data.
- 16. PROHIBITION AGAINST GRATUITIES AND KICKBACKS:** With respect to this procurement and any other contract that bidder may have or wish to enter into with the Government, the bidder represents that he/she has not violated, is not violating, and promises that he will not violate the prohibition against gratuities and kickbacks set forth in the Guam Procurement Regulations – GAR § 11170(e)
- 17. STATEMENT OF QUALIFICATIONS** The ability capacity and skill of the Bidders to perform; Whether the bidder can perform promptly or within the specified time; The quality of performance of the Bidder with regards to awards previously made to him; The sufficiency of the financial resources and ability of the bidders to perform; And the compliance with all of the conditions to the solicitation.
- 18. WAGE AND BENEFIT COMPLIANCE-CONTRACTORS PROVIDING SERVICES:**
- (a) Contractor with regard to all person its employs whose purpose in whole or in part is the direct delivery of services contracted for with the Government of Guam in this procurement, shall pay such employees in accordance with the Wage Determination for Guam and the Northern Marianas Islands issued and promulgated by the U.S. Department of Labor for such labor as is employed in the direct deliverance of deliverables to the government of Guam. 5 GCA § 5801 Contractor shall be responsible for flowing down this obligation to its subcontractors.
 - (b) The Wage Determination most recently issued by the U.S. Department of Labor at the time this Agreement was awarded to Contractor shall be used to determine wages and benefits which shall be paid to employees pursuant to this clause. 5 GCA § 5801
 - (c) Should any contract contain a renewal clause, then at the time of renewal adjustments there shall be stipulations contained in that contract for applying the Wage Determination, so that the Wage Determination promulgated by the U.S. Department of Labor on a date most recent to the renewal date shall apply. 5 GCA § 5801
 - (d) In addition to the Wage Determination detailed above, health and similar benefits for employees having a minimum value as detailed in the wage Determination issued and promulgated by the U.S. Department of labor shall apply. Contractor shall pay a minimum of ten (10) paid holidays per annum per employee. 5 GCA § 5802
 - (e) Any violation of Contractor or its subcontractors obligations of this section shall be investigated by the Guam Department of Labor and may include a monetary penalty assessment by the Guam Department of Labor of no less that One Hundred Dollars (\$100.00) per day, and no more than One Thousand Dollars (\$1,000.00) per day, until such time as a violation has been corrected, as well as the payment of all black wages and benefits due. 5 GCA § 5803
 - (f) In addition to any and all other breach of contract actions the Government of Guam may have under this procurement, in the event there is a violation in the process set forth in subsection (e) above, Contractor may be placed on probationary status by the Chief Procurement Officer of the General Service Agency, or its successor, for a period of one (1) year.
During the probationary status, a Contractor shall not be awarded any contract by any instrumentality of the Government of Guam. A Contractor who has been on probationary status, or has been assessed a monetary

penalty pursuant to 5 GCA Article 13 Title 5 may appeal such penalty of probationary status to the Superior Court of Guam. 5 GCA § 5804

- (g) Contractor along with all proposed offerors and submitter under this procurement were required to submit a Declaration of Compliance with Wage Determination laws as part of this procurement with a copy of the most recent Wage Determination for Guam and the Northern Marianas Islands issued and promulgated by the U.S. Department of Labor. 5 GCA § 5805
 - (h) The applicable USDOL Wage Determination Rate Revision (as defined by subsections (b) and (c) is to this Agreement. Contractor agrees to provide upon written request by the Government of Guam written certification of its compliance with its obligations as part of each invoice, along with the names of any employees, their positions, and detailed wage and benefits paid in keeping with this section. Additionally upon request by Government of Guam the Contractor shall submit source documents as to those individuals provide direct services in part or whole under this Agreement and its payments to them of such wages and benefits.
19. **ETHICAL STANDARDS:** With respect to this procurement and any other contract that the Contractor may have, or wish to enter into, with any Government of Guam agency, the Contractor represents that it has not knowingly influenced, and promises that it will not knowingly influence, any government employee to breach any of the ethical standards set forth in the Guam Procurement Law and in any of the Guam Procurement Regulations. – GAR § 11103 (b).
20. **PROHIBITION AGAINST CONTINGENT FEES:** The Contractor represents that he has not retained any person or agency upon an Agreement or Understanding for a percentage, commission, brokerage, or other contingent arrangement, except for retention of bona fide employees or bona fide established commercial selling agencies, to solicit or secure this Agreement or any contract with the government of Guam or its agencies. GAR § 11108(f)
21. **CONTRACTOR'S WARRANTY AS TO EMPLOYEES AND SEX OFFENSES. Reference 5 GCA 5253(b):** : Contractor warrants that no person providing services on behalf of the Contractor has been convicted of a sex offense under the provisions of Chapter 25 of Title 9 of GCA or an offense as defined in Article 2 of Chapter 28, Title 9 GCA, or an offense in another jurisdiction with, at a minimum, the same elements as such offenses, or who is listed on the Sex Offender Registry.
- Contractor warrants that if any person providing services on behalf of Contractor is convicted of a sex offense under the provisions of Chapter 25 of Title 9 GCA, or an offense as defined in Article 2 of Chapter 28, Title 9 GCA, or an offense in another jurisdiction with, at a minimum, the same elements as such offenses, or who is listed on the Sex Offender Registry, that such person will be immediately removed from working at said agency and that the administrator of said agency be informed of such within twenty-four (24) hours of such conviction. Any contractor found in violation of this section, after notice from the Government of Guam, after notice from the contracting authority of such violation, shall within twenty-four (24) hours, take corrective action and shall report such action to the contracting authority. Failure to take corrective action with the stipulated period may result in the temporary suspension of the contract at the discretion of the Government of Guam.
22. **POLICY IN FAVOR OF SERVICE-DISABLED VETERAN OWNED BUSINESSES:** P.L. 31-115 (September 20, 2011) 5 GCA § 5011 and § 5012 In the procurement of any supply or service, (except for professional services), if such supply or service is offered by a Service Disabled Veteran Owned Business "SDVOB", as defined in 5 GCA § 5012, that is at least fifty one percent (51%) owned by service-disabled veteran(s), and if the supply or service is available within the period that is required for the procurement, and the price for the supply or service does not exceed one hundred five percent (105%) of the lowest bidder price, a preference shall be given to that SDVOB by the Government of Guam, and the supply or service shall be purchased from said SDVOB. This shall be in addition to any other procurement benefit the SDVOB may qualify for under Guam law. A business concern is a qualified SDVOB if: (a) the business concern is licensed to do business on 7Guam; (b) the business concern maintains its headquarters on Guam; (c) the business concern is at least fifty-one (51%) owned by a service-disabled veteran(s) who served in the active U.S. military service, was discharged or released under honorable conditions and whose disability is service-connected as demonstrated by a DD214, and certified by an award letter from the U.S. Department of Veterans Affairs; the DD214 and Disability award letter from U.S. Department of Veterans Affairs are submitted to the Government of Guam procuring agency for every service offered; and the service disabled veteran(s) owner(s) of the business concern has filed individual tax returns on Guam for a period of at least three (3) consecutive years.
23. **CERTIFICATION OF INDEPENDENT PRICE DETERMINATION:** The undersigned Bidder certifies that the bid price submitted was independently arrived at without collusion — GAR § 3126
24. **LICENSING OR CERTIFICATE(S) OF EXEMPTIONS:** Bidders are cautioned that the Government will not consider for award any offer submitted by a bidder who cannot comply with the Guam Licensing Law. Specific information on license or exemptions may be obtained from the Director of Revenue and Taxation.
25. **EQUAL EMPLOYMENT OPPORTUNITY:** Bidder shall not discriminate against any employee or applicant for employment because of race, color, religion, sex, or national origin. The contractor will take affirmative action to ensure that employees are treated equally during employment without regards to their race, color, religion, sex, or national origin.
26. **DISCLOSURES OF MAJOR SHAREHOLDERS:** (5 GCA § 5233) As a condition of submitted a bid, any partnership, sole proprietorship or corporation doing business with the Government of Guam shall submit an affidavit executed under oath that lists the name and address of any person who has held more than ten percent (10%) of the outstanding interest or shares in said month period immediately preceding submission of proposal.



GUAM SOLID WASTE AUTHORITY

LOURDES A. LEON GUERRERO
Governor of Guam

JOSHUA F. TENORIO
Lt. Governor of Guam

IRVIN L. SLIKE
General Manager



IFB TIMETABLE:

The following IFB timetable should be used as a working guide for planning purposes. GSWA reserves the right to adjust this timetable as required during the course of the IFB process.

Registration Form for GSWA IFB Packet will be available on the Guam Solid Waste Authority website at www.gswa.guam.gov .	Friday, November 3, 2023
---	--------------------------

Deadline for Receipt of Written Questions must be e-mailed to the Guam Solid Waste Authority at procurement@gswa.guam.gov , ATTN: General Manager	Thursday, November 9, 2023 on or before 5:00PM Chamorro Standard Time
--	---

Deadline for Answers to Written Questions will be e-mailed to Offerors who registered.	Wednesday, November 14, 2023 on or before 5:00PM Chamorro Standard Time
--	---

Bid Due Date & Bid Opening at the Guam Solid Waste Authority: Administration Office, GSWA Bldg., 2 nd Floor, 546 N. Marine Corps Dr., Tamuning, Guam	Monday, November 20, 2023 at 1:00PM Chamorro Standard Time
---	--



GUAM SOLID WASTE AUTHORITY

LOURDES A. LEON GUERRERO
Governor of Guam

JOSHUA F. TENORIO
Lt. Governor of Guam

IRVIN L. SLIKE
General Manager



ITEM NO.	DESCRIPTION	QTY	UOM	UNIT PRICE	PRICE EXTENSION
1.0	Compact Wheel Loader w/ Attachments	1	EA	\$ 227,261.18	\$ 227,261.18

SPECIFICATIONS:

Indicate on each line of the technical specifications whether or not each item complies with the specification or an exception is being taken. If additional space is required to fully explain bid exceptions, attach additional typed page(s) to the bid submittal indicating the section number and subsection that has the exception, and provide explanation.

	COMPLY / NON-COMPLIANCE
Engine: Gross HP at 2400 RPM: 73 HP minimum	Comply
Peak Torque at 1560 RPM: 206 foot lbs. minimum	Comply
Emissions: Compliant with EPA Final Tier 4/EU Stage V	Comply
Four cylinders	Comply
Powertrain: Hydrostatic with infinitely variable speed control over full range of operating speeds. 2 speed ranges, joystick mounted F-N-R, acceleration pedal.	Comply
Axles: Fixed, 100% differential, manually engaged front axle, fixed conventional differential rear axle or oscillating rear axle	Comply
Max rise and fall single wheel: 15 inches maximum, 14 inch minimum	Comply
Hydraulically activated, self-adjusting internal wet disc brakes and driveline drum brake	Comply
Cooling: Hydraulically driven, proportionally controlled fan or belt-driven fan	Comply
Articulation Angle: 30 degrees each direction	Comply
Cylinders: Heat treated chrome plated polished cylinder rods, hardened steel, replaceable bushings and pivot pins	Comply
Hydraulics: Main pump (loader and steering): 18 GPM standard, 29 GPM with high flow option.	Comply
Quick Coupling: Conforms with ISO 16028 quick coupling for all attachments	Comply
Electrical: Voltage: 12-volt or 24-volt electrical system	Comply
Battery: One (1) 24-volt or two (2) 12-volt	Comply
Battery capacity: One (1) 925 CCA or Two (2) 900 CCA	Comply
Cab: Seat: Air ride high back with head rest and dual lumbar support or mechanical suspension seat	Comply
Noise: Operator ear 70 dBA, Bystander 101 dBA	



GUAM SOLID WASTE AUTHORITY

LOURDES A. LEON GUERRERO
Governor of Guam

JOSHUA F. TENORIO
Lt. Governor of Guam

IRVIN L. SLIKE
General Manager



	COMPLY / NON-COMPLIANCE
Air conditioning	Comply
Steering: Dual tilt and telescoping steering column	Comply
Performance: Conforms with SAE J1040, SAE J231, ISO 3471 and ISO 3449 ROPS/FOPS	Comply
Operating Weight: ISO quick coupler and 1CY general purpose bucket / bolt on edge 12,250 lbs. minimum	Comply
1.4 CY multi-purpose bucket: 12,800 lbs. maximum	Comply
Wheelbase: 7 feet minimum	Comply
Dump clearance: 40-degree full height – 8 feet 3 inches	Comply
Reach: 40-degree full height – 32 inches	Comply
Fork height fully raised: 10 feet minimum	Comply
Fork tipping load straight: 7000 lb. maximum	Comply
Attachments: ISO quick coupling mechanism: Conforms with ISO 16028	Comply
One (1) additional 1.4 CY bucket with bolt on edge	Comply
One (1) Tink claw bucket model 520 or equal	Comply
One (1) 60-inch pick-up broom: 800 lb. minimum; 900 lb. max	Comply
One (1) Fork: 48 inches minimum	Comply
Equipment Warranty: The Bidder guarantees to the Purchaser that the equipment, upon delivery, will be brand new and will have been constructed using entirely new components. Furthermore, the Bidder assures that any new equipment provided shall be free from any defects in manufacturing workmanship and materials for a duration of 24 months or 2,000 hours, whichever occurs first, commencing from the date of equipment delivery. This warranty encompasses any necessary repairs or replacements without any additional cost to the Purchaser.	Comply
Miscellaneous Items: One (1) operator’s manual hardcopy	Comply
One (1) operator’s manual on CD	Comply
One (1) complete illustrated parts book	Comply
One (1) shop repair manual	Comply
One (1) warranty manual	Comply
Manufacturer’s training of GSWA crew (8 hours) & contracted mechanics (20 hours)	Comply
Online manual for parts, service & repair	Comply



GUAM SOLID WASTE AUTHORITY

LOURDES A. LEON GUERRERO
Governor of Guam

JOSHUA F. TENORIO
Lt. Governor of Guam

IRVIN L. SLIKE
General Manager



Delivered with a full tank of fuel

Comply

Note: The GSA Federal Contract will be considered along with its terms and conditions if offered.

Bidding On:

Manufacturer: John Deere

Year: 2024

Model: 244P

Place of Origin: USA

Date of Delivery: 200 Days ARO (Subject to force majeure)

Attachments:

- * Haugen HPB 60-Euro Broom
- * Rockland Multi-Purpose Bucket
- * Tink Claw Bucket C520

244 P

GSWA PROCUREMENT RECORD Page 210



JOHN DEERE

Compact Wheel Loader



244 P-TIER COMPACT WHEEL LOADER



RUN SMALL, DREAM BIG

Your workday is usually long, your tasks can take you into tight places, and you need a multipurpose machine to get everything done. Smaller do-it-all equipment that combines head-turning maneuverability, sure-footed stability, and comfortable capability with productive power, responsive travel speed, and ease of serviceability. Meet the 244 P-Tier Compact Wheel Loader, designed to include a wide range of reliable standard features and proven options that help you imagine the big results this highly adaptable multitasker can deliver for your operation.

FEATURES

Turn things around

Industry-exclusive Articulation Plus™ steering system combines 30 degrees of articulation with 10 additional degrees of rear-wheel steer. Reduced articulation angle design delivers tighter turns that are more stable, especially with large loads, than comparably sized loaders without Articulation Plus.

On the level

Loader arm and coupler design improves the lifting path to near parallel — for better load-carrying capability than previous models. This keeps the load more level from ground to truck-bed height and helps the operator focus on the task instead of on making manual adjustments.

Fast getaway

With a standard top speed of over 23 mph, the 244 P-Tier can make some pretty quick moves on and between jobsites.

Smooth moves

Load-sensing AutoShift powertrain technology eliminates productivity-interrupting manual shifts between gear ranges while providing smooth direction changes.

Control and command

Low-effort joystick controls boom and bucket, forward-neutral-reverse (F-N-R), and differential lock. Standard mini-joystick controls auxiliary hydraulic functions including optional high-flow. Adjustable-height monitor lets operators keep close watch on vital machine functions.

Enjoy the ride

Standard ride control cushions the boom during travel over rough and uneven terrain, reducing material spillage from the bucket and minimizing site cleanup.



**MORE
STABLE***

+



**MORE
MANEUVERABLE***

+



**MORE
CAPABLE***

*Compared to leading competitive articulation loaders of the same size.

Lighten up

In-cab lighting activates when the door is opened to illuminate machine entrances and exits. Optional LED front and rear work-lights brilliantly brighten early morning or after-daylight tasks.

Quick-change artist

Equip your 244 P-Tier with an ISO coupler to quickly and easily go from bucket to forks, for maximum lift capacity. Opt for the available John Deere quick-coupler to utilize a wide array of skid-steer-compatible attachments. High-flow electro-hydraulic-controlled auxiliary hydraulics are also available.

It's a lock

Optional throttle lock and creep control let operators set a slow ground speed while maintaining full engine power to an attachment. Now even easier to activate and adjust on the fly, these functions are perfect for work with snow blowers, cold planers, or material scrapers.

Get a grip

Manual low-speed 100-percent differential lock delivers the ground-gripping tractive effort needed to dive deep into the pile and help heap the bucket. Rimpull control manages power to the wheels, allowing the operator to select the optimal setting to reduce tire and driveline wear.

Keep your cool

Redesigned engine compartment and cooling package improve airflow and reduce the amount of debris entering the system compared to previous models. Access to all daily service checks and cooler cores is from ground level.

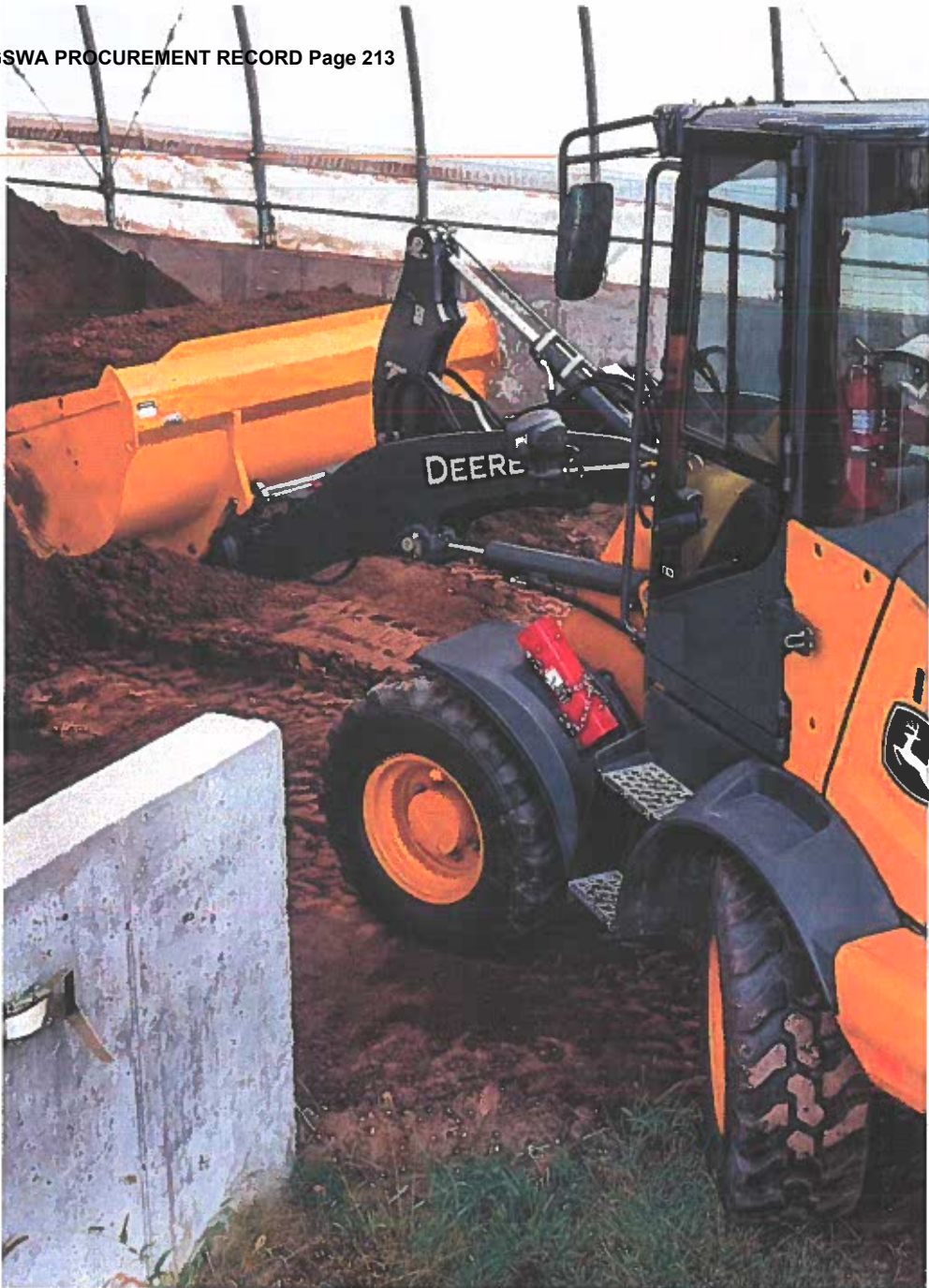

244 P-TIER COMPACT WHEEL LOADER



**OPTIONAL LED
FRONT & REAR WORKLIGHTS
ENHANCE VISIBILITY**

Business booster

John Deere attachments are a great way to expand the flexibility of your operation. With more than 100 models, they'll help you broaden your abilities, work smarter, and accomplish even more.

Here to back you up

Parts and service are always available at over 1,400 John Deere dealer locations throughout North America.

244 P-TIER WHEEL LOADER SPECIFICATIONS

While general information, pictures, and descriptions are provided, some illustrations and text may include product options and accessories NOT AVAILABLE in all regions, and in some countries products and accessories may require modifications or additions to ensure compliance with the local regulations of those countries.

Engine		244 P-TIER	
Manufacturer and Model	Yanmar 4TNV98CT	Gross Rated Power at 2,400 rpm (ISO 14396)	54 kW (73 hp)
Non-Road Emission Standard	EPA Final Tier 4/EU Stage V	Peak Torque at 1,560 rpm	280 Nm (206 lb.-ft.)
Cylinders	4	Engine Bore and Stroke	98 x 110 mm (3.89 x 4.33 in.)
Valves per Cylinder	4	Lubrication	Pressure system with full-flow spin-on filter
Displacement	3.3 L (203 cu. in.)	Aspiration	Turbocharged
Net Peak Power at 2,400 rpm (SAE J1349 / ISO 9249)	52 kW (71 hp)	Air Cleaner	Dual safety element dry type
Cooling			
Fan	Hydraulically driven, proportionally controlled		
Engine Coolant Rating	-37 deg. C (-34 deg. F)		
Powertrain			
Type	Hydrostatic (HST) with infinitely variable speed control over full range of operating speeds; 2 speed ranges; joystick-mounted F-N-R; acceleration pedal; HST inching pedal, which allows infinitely reduced travel speeds while maintaining full engine rpm and hydraulic flow		
2 Travel Speeds in Forward and Reverse (equipped with 365/70R18 tires)			
Gear 1	18 km/h (11.0 mph)		
Gear 2	38 km/h (23.5 mph)		
Axes	Fixed, 100% differential, manually engaged front axle; fixed, conventional differential rear axle		
Rear Axle Oscillation Versus Front Axle	16 deg. total, stop to stop		
Differentials	Manual (push-button) 100% locking front, conventional rear		
Maximum Rise and Fall, Single Wheel	370 mm (14.5 in.)		
Steering	Hydraulic power steering (SAE J1511); 30-deg. articulation left and right with mechanical-actuated rear-wheel steering		
Steering Wheel Turns, Stop to Stop	4¼ (2 left / 2¼ right)		
Articulation Angle	60-deg. arc (30 deg. each direction)		
Final Drive	Heavy-duty outboard planetary		
Brakes (SAE J1473 / ISO 3450)			
Service Brakes	Hydraulically actuated, self-adjusting internal wet-disc brake and driveline drum brake		
Parking Brake	Automatically spring-applied, hydraulically released, internal wet disc		
Hydraulics			
Main Pump (loader and steering)	Fixed-displacement gear pump; open-center system		
Standard	70 L/m (18 gpm)		
Total With High-Flow Option	109 L/m (29 gpm)		
Maximum Pressure at Couplings	23 000 kPa (3,335 psi)		
System Relief Pressure			
Loader	23 000 kPa (3,335 psi)		
Steering	18 000 kPa (2,611 psi)		
Controls	Pilot-operated, 3-function valve with single-lever control for boom and bucket, standard pin disconnect and 3rd-function proportional electrohydraulic (EH) auxiliary hydraulics		
Cylinders			
Type	Heat-treated, chrome-plated, polished cylinder rods; hardened steel (replaceable bushings) pivot pins		
Electrical			
Type	Electrical load center with blade-type multi-fused circuits		
Voltage	12 volt		
Number of Batteries	1		
Battery Capacity	925 CCA		
Alternator Rating	80 amp		
Lights (SAE 99)	Driving/front working lights (2), turn signals, flashers, and stop- and taillights		
Operator Station			
Noise Level			
Operator Ear (ISO 6396)	70 dBA		
Bystander (ISO 6395)	101 dBA		
Tires/Wheels			
Tires on Single-Piece Rims	<i>Tread Width*</i>	<i>Width Over Tires†</i>	<i>Change in Vertical Height</i>
365/70R18 Mitas EMO1 (standard)	1510 mm (4 ft. 11 in.)	1920 mm (6 ft. 4 in.)	0 mm (0 in.)
405/70R18 Firestone Duraforce (optional)	1510 mm (4 ft. 11 in.)	1960 mm (6 ft. 5 in.)	+23 mm (+0.9 in.)
400/70R20 Michelin XMCL (optional)	1510 mm (4 ft. 11 in.)	1960 mm (6 ft. 5 in.)	+44 mm (+1.7 in.)
400/70R20 Michelin Bibload (optional)	1510 mm (4 ft. 11 in.)	1950 mm (6 ft. 5 in.)	+38 mm (+0.9 in.)
400/70R20 Nokian Hakkapeliitta (optional)	1510 mm (4 ft. 11 in.)	1950 mm (6 ft. 5 in.)	+48 mm (+1.9 in.)
*Also see Q in Dimensions section on pages 7 and 9. / †Also see R in Dimensions section on pages 7 and 9.			
Serviceability			
Refill Capacities		Refill Capacities (continued)	
Cooling System (engine and radiator)	12.1 L (12.7 qt.)	Fuel Tank	90 L (23.8 gal.)
Differential and Planetary Axle		Hydraulic/HST Reservoir With Filter	66 L (17.4 gal.)
Front	5.2 L (5.5 qt.)	HST Motor Gearbox	1.7 L (1.8 qt.)
Rear	4.7 L (5.0 qt.)	Front/Rear Axle Planetary Hubs (each)	0.8 L (1.0 qt.)
Engine Oil With Filter	10 L (10.8 qt.)		

244 P-TIER WHEEL LOADER SPECIFICATIONS

244

P

While general information, pictures, and descriptions are provided, some illustrations and text may include product options and accessories NOT AVAILABLE in all regions, and in some countries products and accessories may require modifications or additions to ensure compliance with the local regulations of those countries

Operating Weights

244 P-TIER

With standard equipment, 365/70R18 tires, standard counterweight, cab, 79-kg (175 lb.) operator, and full fuel tank

ISO Quick-Coupler	
With 0.8-m ³ (1.0 cu. yd.) General-Purpose (GP) Bucket With Bolt-On Edge	5560 kg (12,258 lb.)
With 1.1-m ³ (1.4 cu. yd.) GP Bucket With Bolt-On Edge	5680 kg (12,522 lb.)
With Fork	5455 kg (12,026 lb.)
Quik-Tatch™ Quick-Coupler	
With 0.8-m ³ (1.0 cu. yd.) GP Bucket With Bolt-On Edge	5690 kg (12,544 lb.)
With 1.1-m ³ (1.4 cu. yd.) GP Bucket With Bolt-On Edge	5800 kg (12,787 lb.)

Quik-Tatch Quick-Coupler (continued)	
With Fork	5500 kg (12,125 lb.)
Optional Components	
ISO Quick-Coupler	
0.8-m ³ (1.0 cu. yd.) Bucket With Bolt-On Edge	337 kg (743 lb.)
1.1-m ³ (1.4 cu. yd.) Bucket With Bolt-On Edge	457 kg (1,008 lb.)
Fork and Tines	232 kg (511 lb.)
Quik-Tatch Quick-Coupler	
0.8-m ³ (1.0 cu. yd.) Bucket With Bolt-On Edge	467 kg (1,030 lb.)
1.1-m ³ (1.4 cu. yd.) Bucket With Bolt-On Edge	577 kg (1,272 lb.)
Fork and Tines	277 kg (611 lb.)

Dimensions and Specifications With ISO Quick-Coupler and Bucket

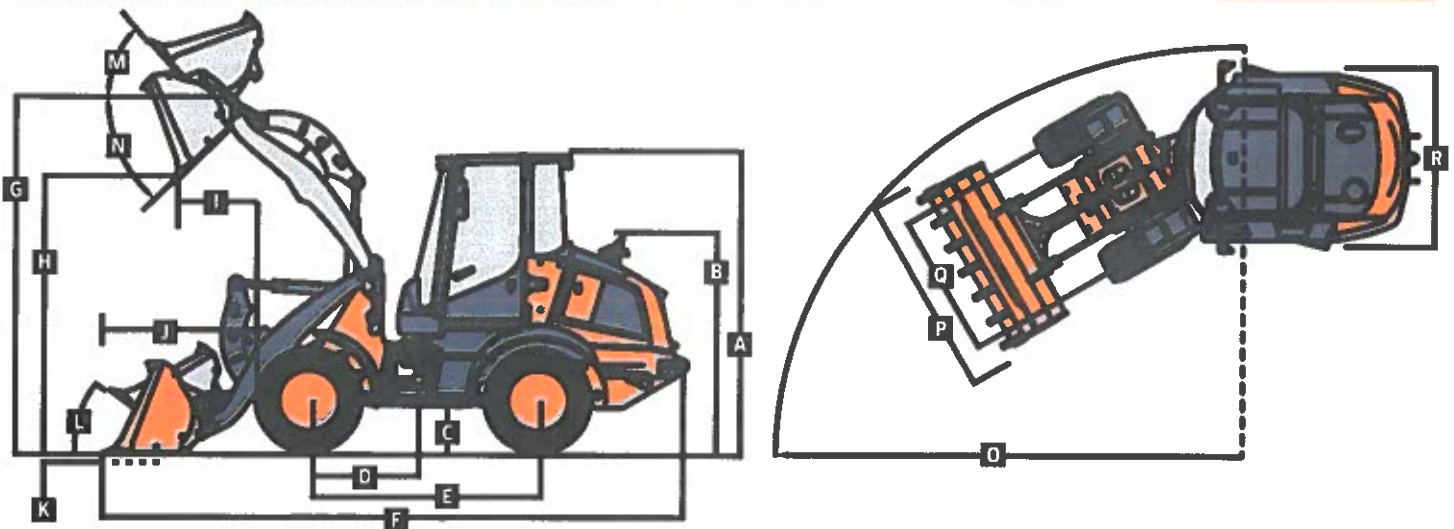

244 P-TIER Z-BAR LOADER WITH ISO QUICK-COUPLER AND BUCKET
Standard Linkage

Dimensions With ISO Quick-Coupler and General-Purpose (GP) Bucket With Bolt-On Edge

- A Height to Top of Cab
- B Height to Top of Exhaust
- C Ground Clearance
- D Length From Centerline to Front Axle
- E Wheelbase
- F Overall Length, Bucket on Ground
- G Height to Hinge Pin, Fully Raised
- H Dump Clearance, 40-deg. Full Height
- I Reach, 40-deg. Dump, Full Height
- J Maximum Dump Reach, 42-deg. Dump
- K Maximum Digging Depth
- L Maximum Rollback at Ground Level
- M Maximum Rollback at Full Height
- N Bucket Dump at Full Height
- O Turning Circle Radius Over Outside of Bucket Edge
- P Bucket Width
- Q Tread Width (standard)^a
- R Width Over Tires (standard)^a

Standard Linkage	Standard Linkage
0.8-m ³ (1.0 cu. yd.)	1.1-m ³ (1.4 cu. yd.)
2.75 m (9 ft. 0 in.)	2.75 m (9 ft. 0 in.)
1.98 m (6 ft. 6 in.)	1.98 m (6 ft. 6 in.)
285 mm (11 in.)	285 mm (11 in.)
750 mm (30 in.)	750 mm (30 in.)
2.15 m (7 ft. 1 in.)	2.15 m (7 ft. 1 in.)
5.41 m (17 ft. 9 in.)	5.47 m (17 ft. 11 in.)
3.22 m (10 ft. 7 in.)	3.22 m (10 ft. 7 in.)
2.52 m (8 ft. 3 in.)	2.48 m (8 ft. 2 in.)
810 mm (32 in.)	860 mm (34 in.)
1.52 m (5 ft. 0 in.)	1.56 m (5 ft. 1 in.)
95 mm (4 in.)	95 mm (4 in.)
39 deg.	39 deg.
55 deg.	55 deg.
42 deg.	42 deg.
3.82 m (12 ft. 6 in.)	3.97 m (13 ft. 0 in.)
1.90 m (6 ft. 3 in.)	2.20 m (7 ft. 3 in.)
1510 mm (4 ft. 11 in.)	1510 mm (4 ft. 11 in.)
1920 mm (6 ft. 4 in.)	1920 mm (6 ft. 4 in.)
7.64 m (25 ft. 1 in.)	7.94 m (26 ft. 1 in.)

Loader Clearance Circle, Bucket Carry Position

^aAlso see Tires/Wheels section on page 6.

Specifications With ISO Quick-Coupler and Bucket

Capacity, Heaped (SAE)	0.8 m ³ (1.0 cu. yd.)	1.1 m ³ (1.4 cu. yd.)
Capacity, Struck (SAE)	0.66 m ³ (0.86 cu. yd.)	0.9 m ³ (1.18 cu. yd.)
Breakout Force (SAE J732C)	4895 kg (10,792 lb.)	4410 kg (9,722 lb.)
Tipping Load, Straight	4060 kg (8,951 lb.)	3930 kg (8,664 lb.)
Tipping Load, Full Turn (SAE)	3700 kg (8,157 lb.)	3580 kg (7,893 lb.)
Rated Operating Load, 50% of Full-Turn Tipping Load (conforms to ISO 14397-1)*	1850 kg (4,079 lb.)	1790 kg (3,946 lb.)

*Rated operating capacity based on Deere attachments only.

Dimensions and Specifications With ISO Quick-Coupler and Fork

244 P-TIER

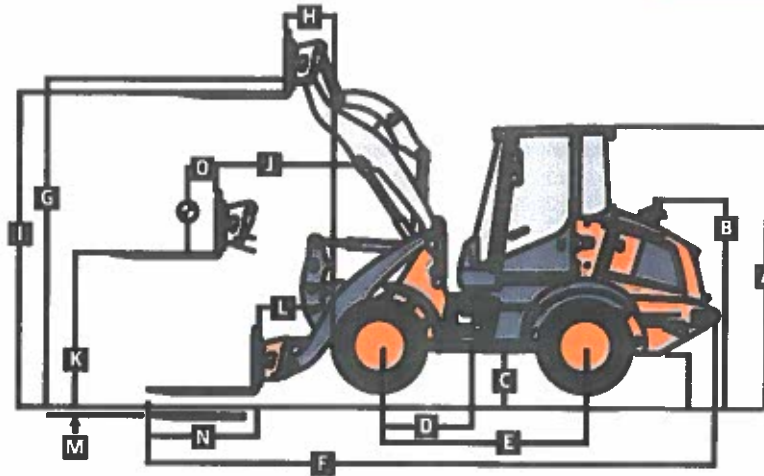

244 P-TIER Z-BAR LOADER WITH ISO QUICK-COUPLER AND FORK

Dimensions With ISO Quick-Coupler and Fork

- A Height to Top of Cab
- B Height to Top of Exhaust
- C Ground Clearance
- D Length From Centerline to Front Axle
- E Wheelbase
- F Overall Length, Forks on Ground
- G Height to Hinge Pin, Fully Raised
- H Reach, Fully Raised
- I Fork Height, Fully Raised
- J Maximum Reach, Fork Level
- K Fork Height, Maximum Reach
- L Reach, Ground Level
- M Depth Below Ground
- N Tine Length
- O Load Position, 50% Tine Length

Specifications With ISO Quick-Coupler and Fork

- Tipping Load, Straight 3215 kg (7,088 lb.)
- Tipping Load, Full Turn (SAE) 2930 kg (6,460 lb.)
- Rated Operating Load, 50% Full-Turn Tipping Load (conforms to SAE J1197 / ISO 14397-1)* 1465 kg (3,230 lb.)[†]
- Rated Operating Load, Rough Terrain, 60% Full-Turn Tipping Load (conforms to EN474-3)* 1820 kg (4,012 lb.)[†]
- Rated Operating Load, Firm and Level Ground, 80% Full-Turn Tipping Load (conforms to EN474-3)* 2300 kg (5,071 lb.)[†]

*Rated operating capacity based on Deere attachments only. / [†]Payload on forks is limited by tilt cylinder.

Standard Linkage

- 1.20-m (48 in.) tine length
- 2.75 m (9 ft. 0 in.)
- 1.98 m (6 ft. 6 in.)
- 285 mm (11 in.)
- 750 mm (30 in.)
- 2.15 m (7 ft. 1 in.)
- 5.99 m (19 ft. 8 in.)
- 3.22 m (10 ft. 7 in.)
- 525 mm (21 in.)
- 3.05 m (10 ft. 0 in.)
- 1.24 m (4 ft. 1 in.)
- 1.45 m (4 ft. 9 in.)
- 740 mm (29 in.)
- 50 mm (2 in.)
- 1.20 m (48 in.)
- 600 mm (24 in.)

As measured with fork level, centered on tine

While general information, pictures, and descriptions are provided, some illustrations and text may include product options and accessories NOT AVAILABLE in all regions, and in some countries products and accessories may require modifications or additions to ensure compliance with the local regulations of those countries.

Dimensions and Specifications With Quik-Tatch™ Coupler and Bucket

244 P-TIER

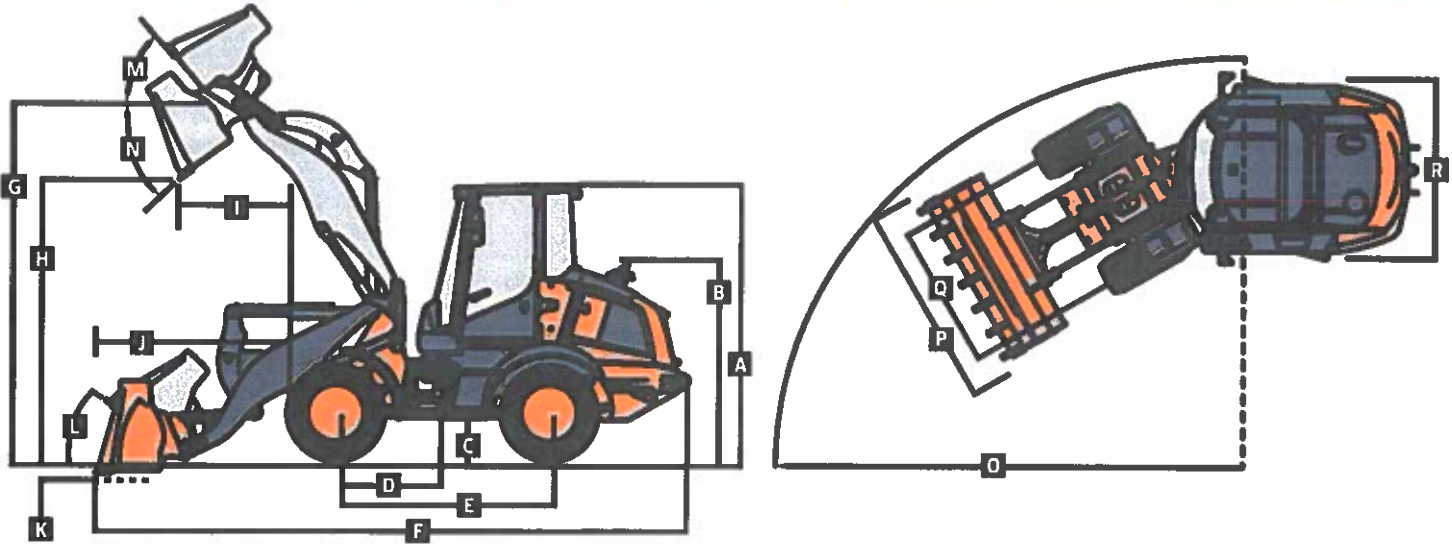

244 P-TIER Z-BAR LOADER WITH QUIK-TATCH COUPLER AND BUCKET

Dimensions With Quik-Tatch Coupler and General-Purpose (GP) Bucket With Bolt-On Edge

- A Height to Top of Cab
- B Height to Top of Exhaust
- C Ground Clearance
- D Length From Centerline to Front Axle
- E Wheelbase
- F Overall Length, Bucket on Ground
- G Height to Hinge Pin, Fully Raised
- H Dump Clearance, 40-deg. Full Height
- I Reach, 40-deg. Dump, Full Height
- J Maximum Dump Reach, 42-deg. Dump
- K Maximum Digging Depth
- L Maximum Rollback at Ground Level
- M Maximum Rollback at Full Height
- N Bucket Dump at Full Height
- O Turning Circle Radius Over Outside of Bucket Edge
- P Bucket Width
- Q Tread Width (standard)[§]
- R Width Over Tires (standard)[§]

Loader Clearance Circle, Bucket Carry Position

[§]Also see *Tires/Wheels* section on page 6.

Specifications With Quik-Tatch Coupler and Bucket

- Capacity, Heaped (SAE)
- Capacity, Struck (SAE)
- Breakout Force (SAE J732C)
- Tipping Load, Straight
- Tipping Load, Full Turn (SAE)
- Rated Operating Load, 50% of Full-Turn Tipping Load (conforms to ISO 14397-1)*

*Rated operating capacity based on Deere attachments only.

Standard Linkage

- 0.8-m³ (1.0 cu. yd.)
- 2.75 m (9 ft. 0 in.)
- 1.98 m (6 ft. 6 in.)
- 285 mm (11 in.)
- 750 mm (30 in.)
- 2.15 m (7 ft. 1 in.)
- 5.61 m (18 ft. 5 in.)
- 3.22 m (10 ft. 7 in.)
- 2.52 m (8 ft. 3 in.)
- 1.09 m (3 ft. 7 in.)
- 1.71 m (5 ft. 7 in.)
- 55 mm (2 in.)
- 50 deg.
- 58 deg.
- 40 deg.
- 3.87 m (12 ft. 8 in.)
- 1.90 m (6 ft. 3 in.)
- 1510 mm (4 ft. 11 in.)
- 1920 mm (6 ft. 4 in.)
- 7.73 m (25 ft. 4 in.)

Standard Linkage

- 1.1-m³ (1.4 cu. yd.)
- 2.75 m (9 ft. 0 in.)
- 1.98 m (6 ft. 6 in.)
- 285 mm (11 in.)
- 750 mm (30 in.)
- 2.15 m (7 ft. 1 in.)
- 5.68 m (18 ft. 7 in.)
- 3.22 m (10 ft. 7 in.)
- 2.45 m (8 ft. 0 in.)
- 1.15 m (3 ft. 9 in.)
- 1.76 m (5 ft. 9 in.)
- 55 mm (2 in.)
- 50 deg.
- 58 deg.
- 40 deg.
- 4.02 m (13 ft. 2 in.)
- 2.20 m (7 ft. 3 in.)
- 1510 mm (4 ft. 11 in.)
- 1920 mm (6 ft. 4 in.)
- 8.03 m (26 ft. 4 in.)

Capacity, Heaped (SAE)	0.8 m ³ (1.0 cu. yd.)	1.1 m ³ (1.4 cu. yd.)
Capacity, Struck (SAE)	0.66 m ³ (0.86 cu. yd.)	0.9 m ³ (1.18 cu. yd.)
Breakout Force (SAE J732C)	3645 kg (8,036 lb.)	3295 kg (7,264 lb.)
Tipping Load, Straight	3620 kg (7,981 lb.)	3500 kg (7,716 lb.)
Tipping Load, Full Turn (SAE)	3310 kg (7,297 lb.)	3200 kg (7,055 lb.)
Rated Operating Load, 50% of Full-Turn Tipping Load (conforms to ISO 14397-1)*	1655 kg (3,649 lb.)	1600 kg (3,527 lb.)

While general information, pictures, and descriptions are provided, some illustrations and text may include product options and accessories NOT AVAILABLE in all regions, and in some countries products and accessories may require modifications or additions to ensure compliance with the local regulations of those countries.

Dimensions and Specifications With Quik-Tatch Coupler and Fork

244 P-TIER

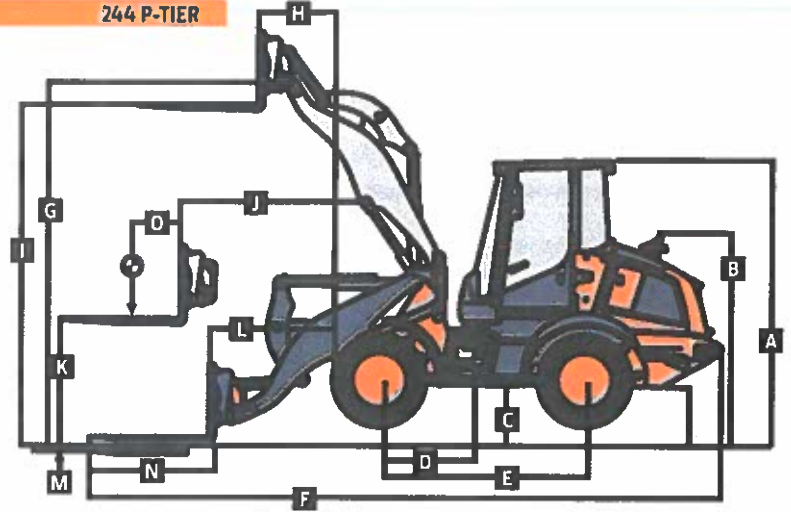

244 P-TIER Z-BAR LOADER WITH QUIK-TATCH COUPLER AND FORK

Dimensions With Quik-Tatch Coupler and Fork

- A Height to Top of Cab
- B Height to Top of Exhaust
- C Ground Clearance
- D Length From Centerline to Front Axle
- E Wheelbase
- F Overall Length, Forks on Ground
- G Height to Hinge Pin, Fully Raised
- H Reach, Fully Raised
- I Fork Height, Fully Raised
- J Maximum Reach, Fork Level
- K Fork Height, Maximum Reach
- L Reach, Ground Level
- M Depth Below Ground
- N Tine Length
- O Load Position, 50% Tine Length

Specifications With Quik-Tatch Coupler and Fork

- Tipping Load, Straight
- Tipping Load, Full Turn (SAE)
- Rated Operating Load, 50% Full-Turn Tipping Load (conforms to SAE J1197 / ISO 14397-1)*
- Rated Operating Load, Rough Terrain, 60% Full-Turn Tipping Load (conforms to EN474-3)*
- Rated Operating Load, Firm and Level Ground, 80% Full-Turn Tipping Load (conforms to EN474-3)*

Standard Linkage
1.20-m (48 in.) tine length

- 2.75 m (9 ft. 0 in.)
- 1.98 m (6 ft. 6 in.)
- 285 mm (11 in.)
- 750 mm (30 in.)
- 2.15 m (7 ft. 1 in.)
- 6.08 m (19 ft. 11 in.)
- 3.22 m (10 ft. 7 in.)
- 570 mm (22 in.)
- 3.03 m (9 ft. 11 in.)
- 1.28 m (4 ft. 2 in.)
- 1.42 m (4 ft. 8 in.)
- 785 mm (31 in.)
- 75 mm (3 in.)
- 1.20 m (48 in.)
- 600 mm (24 in.)

As measured with fork level, centered on tine

- 3060 kg (6,746 lb.)
- 2800 kg (6,173 lb.)
- 1400 kg (3,086 lb.)¹
- 1680 kg (3,704 lb.)¹
- 2160 kg (4,762 lb.)¹

*Rated operating capacity based on Deere attachments only. / ¹Payload on forks is limited by tilt cylinder.

Bucket Selection Guide

LOOSE MATERIALS	kg/m ³	#/cu. yd.	LOOSE MATERIALS	kg/m ³	#/cu. yd.
Chips, pulpwood	288	486	Limestone, coarse, dried	970	2,646
Cracked coal, ashes, cinders ¹	673	1,104	Limestone, substandard or crushed	882	2,835
Clay and gravel, dry	3602	2,300	Limestone, pulverized or crushed	1362	2,795
Clay, compact, solid	1746	2,943	Sand, damp	2083	3,570
Clay, dry in lump loose	1009	1,701	Sand, dry	1762	2,970
Clay, excavated in water	1282	2,360	Sand, voids, full of water	2083	3,570
Coal, anthracite, broken, loose	885	1,458	Sandstone, quarried	1314	2,274
Coal, bituminous, moderately wet	901	1,550	Shale, broken or crushed	1363	2,295
Earth, common loam, dry	1218	2,057	Slag, furnace granulated	1955	3,294
Earth, mud, packed	1843	3,105	Stone or gravel, 12.5 to 87.5 mm		
Granite, broken	1538	2,592	(1.5 to 3.5 in.) size	1667	2,430
Gypsum	2275	3,824	Stone or gravel, 18.75-mm (3/4 in.) size	1672	2,700

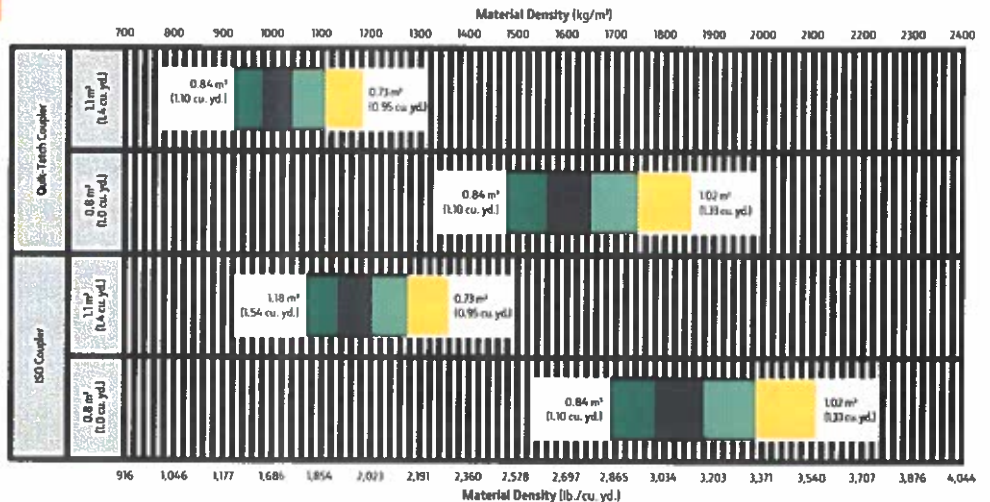

Additional equipment

Key: ● Standard ▲ Optional or special
See your John Deere dealer for further information.

244 P Engine

- Antifreeze, -37 deg. C (-34 deg. F)
- Coolant recovery tank
- Fan safety guard
- Fan, suction type, hydraulically driven, proportional speed
- Environmentally friendly engine oil drain
- Spin-on engine oil and fuel filter
- Engine oil cooler
- Quick-release fuel filter and water separator
- Under-hood dual-element air cleaner with restriction indicator with dust-evacuator valve
- Prescreened air intake
- Automatic glow plugs for cold start
- ▲ Engine coolant heater, 110 volts

Electrical

- Starter switch with electric fuel cutoff
- 12-volt system
- Electrical load center with blade-type fuses behind operator's seat
- Standard 925-CCA battery
- Master electrical disconnect switch
- Alternator, 12 volts, 80 amps
- Horn (conforms to SAE J994 / J1446)
- Lights (conform to SAE 99): Driving / Front working (2) / Turn signals / Flashers / Stop / Taillights
- Worklights, rear (2)
- Reverse warning alarm (conforms to SAE J994 / J1446)
- Multifunction monitor with audible and visual warnings: Low engine oil pressure, engine coolant temperature, hydraulic oil temperature warning light, and parking brake indicator / Gauge and indicator: Engine coolant temperature gauge, fuel level gauge, speedometer, clock, and hour meter
- Indicator lights: Engine air filter / Parking brake actuated / Forward/reverse travel / 1st- or 2nd-speed range / Turn signal and hazard lights / High-beam driving lights indicator / Battery voltage
- Pre-wired for roof beacon

Powertrain/Brakes

- Smooth AutoShift technology up to 38 km/h (23 mph)

244 P Powertrain/Brakes (continued)

- Hydrostatic (HST) transmission: Electric shift control / Single-lever joystick F-N-R / HST oil cooler / Inching pedal / 2 speeds forward and reverse / Infinitely variable speed control
- Rimpull control
- Service brakes, hydraulically actuated, self-adjusting internal wet-disc brake and driveline drum brake
- Parking brake, spring applied, hydraulically released, switch operated
- Conventional-type rear differentials, 100% locking front differential

Hydraulic System

- Hydraulic fan for demand-based cooling
- Hydraulic system oil cooler
- Automatic bucket return-to-dig control
- Boom float detent
- Reservoir sight gauge for hydraulic/HST oil
- Fine-micron hydraulic filters, vertical mounting
- Hydraulic function lockout
- 3-function hydraulic valve with pilot joystick control including auxiliary electrohydraulic (EH) proportional control for 3rd function
- ▲ 109-L/m (29 gpm) high-flow option
- Quick-coupler diagnostic ports: Priority pressure / Hydraulic pump pressure / Control valve pressure / HST pressure

Operator's Station

- Cab (conforms to SAE J1040, SAE J231, ISO 3471, and ISO 3449): ROPS/FOPS / Heater/defroster / Rubber-plane isolation mounted for noise/vibration reduction / Intermittent front and rear windshield wipers and washers / Tinted safety glass / Adjustable sun visor / Mid-back cloth seat with mechanical suspension / 51-mm (2 in.) retractable seat belt / Full swing-out left and right doors with sliding window in left door
- ▲ Premium air-ride high-back heated seat with headrest and dual lumbar control
- Radio-ready cab, fused 12-volt radio electrical lead and speakers, and power port
- ▲ AM/FM/Weather-Band (WB) radio

244 P Operator's Station (continued)

- Air conditioning
- Storage compartment for operator's manual and other items located under operator seat and 2 options left of operator seat
- Rubber floor mat
- Dual tilt and telescoping steering column
- Rearview mirrors, outside (2) and inside (1) (conform to SAE J985)
- Handholds and steps, ergonomically located and slip resistant (conform to SAE J185)
- ▲ 76-mm (3 in.) retractable seat belt

Loader Linkage

- Z-Bar loader linkage provides high bucket breakout
- Loader boom service locking bar (conforms to SAE J38)

Buckets and Attachments

- ▲ Full line of buckets with bolt-on cutting edges
- ▲ ISO-style quick-coupler
- ▲ Quik-Tatch™ coupler
- ▲ Full line of construction utility forks, pallet forks, and other John Deere attachments*

Tires

- 365/70R18 Mitas EM-01
- ▲ 405/70R18 Firestone Duraforce
- ▲ 400/70R20 Michelin XMCL
- ▲ 400/70R20 Michelin Bibload
- ▲ 400/70R20 Nokian Hakkapeliitta

Other

- ▲ LED worklights (spot or flood)
- ▲ Hydraulic reversing fan
- ▲ Front window guard
- Fenders, front and rear
- Articulation locking bar (conforms to SAE J276)
- Vandal protection, includes lockable engine enclosure and fuel fill
- Cast rear counterweight
- Drawbar, with locking pin
- Life eyes
- Tie-downs
- Ride control
- ▲ Creep control/throttle lock
- ▲ Fire extinguisher

*See your John Deere dealer for further information.

While general information, pictures, and descriptions are provided, some illustrations and text may include product options and accessories NOT AVAILABLE in all regions, and in some countries products and accessories may require modifications or additions to ensure compliance with the local regulations of those countries.

Net engine power is with standard equipment including air cleaner, exhaust system, alternator, and cooling fan, at standard conditions per SAE J1349 and DIN 70 020, using No. 2-D fuel at 35 API gravity. No derating is required up to 1500-m (5,000 ft.) altitude. Gross power is without cooling fan. Specifications and design subject to change without notice. Wherever applicable, specifications are in accordance with SAE standards. Except where otherwise noted, these specifications are based on a unit with all standard equipment, ROPS cab, 365/70R18 Mitas EM-01 tires, full fuel tank, air conditioning off, and 79-kg (175 lb.) operator.



MW244PAU (23-05)



JOHN DEERE



STANDARD WARRANTY FOR NEW JOHN DEERE CONSTRUCTION, COMPACT CONSTRUCTION (CCE) FORESTRY, AND UTILITY PRODUCTS – US & CANADA

- **Construction & Forestry Products:** 12 months/unlimited hours (whichever occurs first) Full Machine Standard Warranty
- **Compact Construction Equipment (CCE) Products:** 24 months or 2000 hours (whichever occurs first) Full Machine Standard Warranty
- **C&E Series Pull-Type Scrapers:** 6 months Full Machine Standard Warranty
- **DC & DE Pull-Type Scrapers:** 12 months Full Machine Standard Warranty
- **Scraper Tractors:** 24 Months or 2000 Hours (whichever occurs first) Full Machine Standard Warranty
- **Forestry Attachments:** 12 Months or 2000 Hours (whichever occurs first) Full Machine Standard Warranty

The "Standard Warranty" is part of the warranty protection package available from John Deere Construction & Forestry Company (John Deere Limited in Canada) ("John Deere") to purchasers of new John Deere products ("product"):

STANDARD Warranty is John Deere's standard new product warranty, described in this document, provided at no additional charge to the purchaser.

EXTENDED Warranty is a separate repair contract made available by John Deere for purchasers who wish to complement their Standard Warranty coverage. Complete Extended Warranty details, including coverage options and limitations, are set forth in the Application for Extended Warranty, which is available from authorized John Deere dealers.

STRUCTURALL Warranty applies to certain structural components as listed below and as described in this document.

FACTORY-INSTALLED UNDERCARRIAGE Warranty applies to certain undercarriage components as listed below and as described in this document.

A. STANDARD WARRANTY - GENERAL PROVISIONS

John Deere will repair or replace, at its option, any parts (except those specified below) of a new John Deere product that, as delivered to the original retail purchaser(s), are defective in material or workmanship. Performance of this warranty will be free of charge for parts and labor, except as otherwise stated below. Standard Warranty applies only to purchases from John Deere and authorized John Deere dealers and, except as otherwise provided in the next sentence and section L below, is extended only to the original retail purchaser of the product. Remaining Standard Warranty applicable to a used John Deere product is transferred to a subsequent purchaser of the product only if the subsequent purchaser requests a transfer from an authorized John Deere dealer before the product's Standard Warranty expires. Coverage begins on the date of delivery of the product to the original retail purchaser. For purposes of this warranty, a product that has been rented, used for demonstration purposes for 150 or more hours, or otherwise used prior to its original retail purchase has been "used" for the total duration of such use. Warranty statements required by law covering engine emissions-related parts and components are found on a separate written warranty certificate provided to the purchaser at the time of the original retail purchase.

B. WHAT IS COVERED BY STANDARD WARRANTY

All parts of a new John Deere product (except those noted in Sections D and E below) are covered during the Standard Warranty period set out above.

C. EXCLUSIVE REMEDY

The repair or replacement of covered parts or components that are defective, as provided in Sections A, B, D.2 and D.3 herein, shall be the purchaser's exclusive remedy for any defect in the product. However, if after repeated attempts such repair or replacement fails to correct the performance problem caused by the defect, the purchaser's sole remedy shall be a refund of the amount paid for the product (in exchange for a return of the product), excluding any transportation charges, license fees, taxes and insurance premiums, and less a reasonable allowance for use of the product prior to its return. In no event will the dealer, John Deere or any company affiliated with John Deere be liable for any incidental or consequential damages, including but not limited to loss of profits, rental of substitute equipment or other commercial loss. Correction of defects in the manner provided above shall constitute fulfillment of

all liabilities of the Dealer, John Deere, or any company affiliated with John Deere to the purchaser or any other person, whether based upon contract, tort, strict liability, or otherwise. This limitation does not apply to claims for personal injury.

D. ITEMS COVERED SEPARATELY -

1. **Standard Warranty** does not apply to batteries, radios, tires, cameras, or to Cummins, MTU or Detroit Diesel Engines installed in John Deere products, which are covered by separate written warranties.
2. **Factory-Installed Undercarriage Warranty** covers all non-rubberized factory-installed undercarriage wear components for 3 years or 4,000 hours from the date of delivery to the original retail purchaser, whichever occurs first (unless terminated earlier under Section F, below). For purposes of this warranty, a product that has been rented, used for demonstration purposes for 150 or more hours, or otherwise used prior to its original retail purchase has been "used" for the total duration of such use. In addition to the items listed in section E below, **Factory-Installed Undercarriage Warranty** does not cover: failures due to wear, machine application, maintenance practices, or improper machine configuration; removal and installation labor; transportation or hauling costs; unapproved parts; non-wear items; and rubberized undercarriage components such as rubber tracks. Warranty claims will be pro-rated based upon wear of the failed component and whether track shoe width is approved by John Deere. **Factory-Installed Undercarriage Warranty** does not apply to Scraper Tractors.
3. **StructurALL Warranty** for new John Deere Products (except Compact Excavators & Loaders, Skid-Steer Loaders, Compact Track Loaders, Scraper Tractors, Pull-Type Scrapers, and Forestry Attachments, which are not eligible for **StructurALL Warranty**) begins at the date of delivery to the original retail purchaser and ends (unless terminated earlier under Section F, below) after three (3) years, or 10,000 hours (whichever occurs first). For purposes of this warranty, a product that has been rented, used for demonstration purposes for 150 or more hours, or otherwise used prior to its original retail purchase has been "used" for the total duration of such use. **StructurALL Warranty applies only to the following structural components listed below as installed on the product at the time of original manufacture.** If a particular component is not listed below it is not covered by **StructurALL Warranty**.

Arm; Articulation Joint (incl. pins & bushings); Bin Frame; Boom; Carbody; C-Frame*; Circle Frame; Coupler (John Deere built ONLY); Dipperstick; Draft Frame; Engine Frame; Equipment Frame; Grapple Arch and Grapple Boom; Loader Arm; Loader Frame; Mainframe; Moldboard Lift Arm; Pushbeam, NeverGrease™ Pin Joints [Includes steering pin and bushing joints (standard equipment), roller elements (roller bearings) in bucket to boom joints and sliding elements (bushing) for boom and linkage joints (optional equipment)]; Rollover Protection Structure (ROPS); Side Frame; Swing Frame; Track Frame; Undercarriage Frame; X-Frame; Z-bar loader linkage (including bell crank and bucket driver link); Specialty booms and arms marketed as "heavy duty" by John Deere.

Items Covered by StructurALL for Cut-to-Length Forestry Machines: Front frame (welded assembly); Rear frame (welded assembly); Crane king post with basement; Middle joint frame; Cabin swing frame; Main Boom

StructurALL Warranty does not apply to:

1. Any product used primarily in extreme duty or severe duty applications such as but not limited to: demolition and wrecking, chemical plant (including fertilizer plants), salt mines, steel mill, land fill and transfer stations, scrap handling, scarifying and other applications that are similarly destructive or similarly heavy duty except specialty booms and arms as stated in Section D.3 above.
2. C-Frames on Crawlers equipped with root rakes or used in forestry applications unless equipped with an "extreme duty" reinforcement package.
3. Cut-to-Length Forestry Heads and Slash Bundler Units.
4. Crawlers equipped with optional side booms.
5. Cut-to-Length Forestry, Excavator, and Log Loader swing bearings.
6. Motor Graders equipped with front- or rear-mounted snow wings.

E. ITEMS NOT COVERED -

John Deere is NOT responsible for the following:

1. Freight.
2. Adjustments to compensate for wear, for periodic maintenance or adjustments that result from normal wear and tear.
3. Damage caused by unapproved adjustments (electronic or mechanical) to machine or machine components outside of published specifications including but not limited to engine, hydraulic components and relief valves.
4. Program updates, calibrations, and pressure adjustments.
5. Additional Labor Time - Above Dealer Labor Rate.
6. Additional Cleaning - Above Dealer Labor Rate.
7. Rental Fees.
8. Depreciation or damage caused by normal wear or application, lack of reasonable and proper maintenance, failure to follow operating instructions, misuse, lack of proper protection during storage, vandalism, negligence, collision, expenses to seek reinstatement of warranty following theft or loss of Product, or other accidents.
9. Premiums charged for Overtime Labor.
10. Transportation to and from the dealership.
11. Travel time, mileage, or service calls by the dealer.
12. Non-John Deere components or modifications, Rotobec grapples, and attachments installed aftermarket.
13. Shop supplies and maintenance items such as, but not limited to: filters, fuels, oil, hydraulic fluid, lubricants, coolants, conditioners, shop towels, cleaners and degreasers.
14. Torn, cut, or worn hoses.
15. Wear items, such as, but not limited to: body liner, belts, blades, bulbs, lubricated joints (including pins and bushings), dry brakes, brake linings, dry clutch linings, saw blades, chains, skidder grapple shocks, color marking nozzles, and articulation bumpers.
16. Items such as cutting-edge parts, delimiting knives, bucket teeth and rubber track are not warranted for depreciation or damage caused by normal wear, lack of proper maintenance, misuse, failure to follow operating instructions, the elements or accident.
17. Any defect in a non-covered component, or damage to or failure of a covered component caused by a defect in a non-covered component.
18. Secondary damage which occurs from continued operation of a product after recognition of the occurrence of a failure.
19. Parts supplied by or repairs, maintenance or modifications performed by someone other than an authorized John Deere dealer, including any damage caused by such use of parts, repairs, maintenance, or modifications not performed by an authorized John Deere dealer.
20. The use of "track type" tire chains on Feller Bunchers and Skidders is an unapproved modification. Warranty will be void on these machines using "track type" tire chains.
21. Topping off fluids when fluid levels fall in the range between low and full
22. Parts/Kits not ordered on machine and installed aftermarket. These parts will be covered by any applicable parts warranty.
23. Attachments installed aftermarket – i.e., Winch not installed at factory.
24. Custom options installed outside the factory – i.e., G.R. Manufacturing option packages.
25. Used Products (except as otherwise provided in section L below).
26. Lost or stolen Products.

F. TERMINATION OF WARRANTY-

John Deere is relieved of its obligations under Standard Warranty, StructurALL Warranty, Factory-Installed Undercarriage Warranty and/or Extended Warranty if:

1. The product is modified or altered in ways not approved by John Deere; or
2. Any unapproved or improperly sized attachment is installed on the product. Approval and attachment size shall be at John Deere's sole discretion. (Consult dealer prior to installing attachments or product modification).
3. The product is moved outside the US and/or Canada.

G. PARTS REPLACED UNDER WARRANTY -

Only new or remanufactured parts or components furnished or approved by John Deere, will be used if John Deere elects to repair the product. If any such part or component is defective in material or workmanship when installed in the product, John Deere will repair or replace, as it elects, such defective part or component, provided the defect is reported to an authorized John Deere dealer within 90 days of installation or before expiration of the applicable Standard Warranty, Factory-Installed Undercarriage Warranty and/or StructurALL Warranty whichever is later.

H. TELEMATICS

NOTICE: Products may be equipped with telematics hardware and software ("Telematics") that transmit data to John Deere/ Dealer. Purchaser may deactivate Telematics at www.jdlink.com.

Notwithstanding Purchaser's right, title or interest in the Products, Purchaser agrees that John Deere and Dealer (their affiliates, successors and assigns), without further notice to Purchaser have the right to:

1. Access, use, collect and disclose any data generated by, collected by, or stored in, Products or any hardware or devices interfacing with Products ("Machine Data");
2. Access Machine Data directly through data reporting devices integrated within, or attached to, Products, including Telematics ("Data Reporting Systems"); and
3. Update the Data Reporting Systems software from time to time. Machine Data will only be used in accordance with John Deere's Machine Data Policy, located at www.JohnDeere.com/MachineDataPolicy.

I. OBTAINING WARRANTY SERVICE -

To obtain warranty service, the purchaser must request warranty service from a John Deere dealer authorized to sell the product to be serviced. When making such a request, the purchaser must present evidence of the product's delivery date, make the product available at the dealer's place of business, and inform the dealer in what way the purchaser believes the product to be defective. Standard Warranty, Factory-Installed Undercarriage Warranty and/or StructurALL Warranty repairs may be made in the field if the purchaser and servicing dealer so desire. However, John Deere will not be responsible for any charges (such as dealer travel time, mileage or extra labor) that would not have been incurred had the product been repaired at the dealer's place of business.

J. NO IMPLIED WARRANTY, CONDITIONS OR OTHER REPRESENTATION -

Where permitted by law, neither John Deere nor any company affiliated with it makes any warranties, representations, conditions or promises, express or implied, as to the quality, performance, or freedom from defect of its products, other than those set forth in this document and **NO IMPLIED WARRANTY OF MERCHANTABILITY, CONDITIONS OR FITNESS IS MADE.**

K. NO DEALER WARRANTY -

The selling dealer makes no warranty of its own on any item covered by this warranty and makes no warranty on other items unless the dealer delivers to the purchaser a separate written warranty certificate specifically warranting the item. **The dealer has no authority to make any representation or promise on behalf of John Deere, or to modify the terms or limitations of this warranty in any way.**

L. USED JOHN DEERE PRODUCTS ONLY -

John Deere will transfer remaining Standard Warranty, Factory-Installed Undercarriage Warranty and/or StructurALL Warranty to the purchaser of a used John Deere construction and/or forestry product that has been used for less than the full warranty period provided at the product's original retail purchase. This transfer is not effective until change of ownership is registered by a John Deere dealer. **ALL THE TERMS, INCLUDING LIMITATIONS AND EXCLUSIONS, OF THE JOHN DEERE STANDARD WARRANTY, FACTORY-INSTALLED UNDERCARRIAGE WARRANTY, AND/OR STRUCTURALL WARRANTY ORIGINALLY PROVIDED FOR THE PRODUCT REMAIN IN EFFECT AND APPLICABLE.**

TINK BUCKETS



Load A
Compactor Truck



Load An
Open Top Truck



Efficient Collection
Of Leaves & Brush

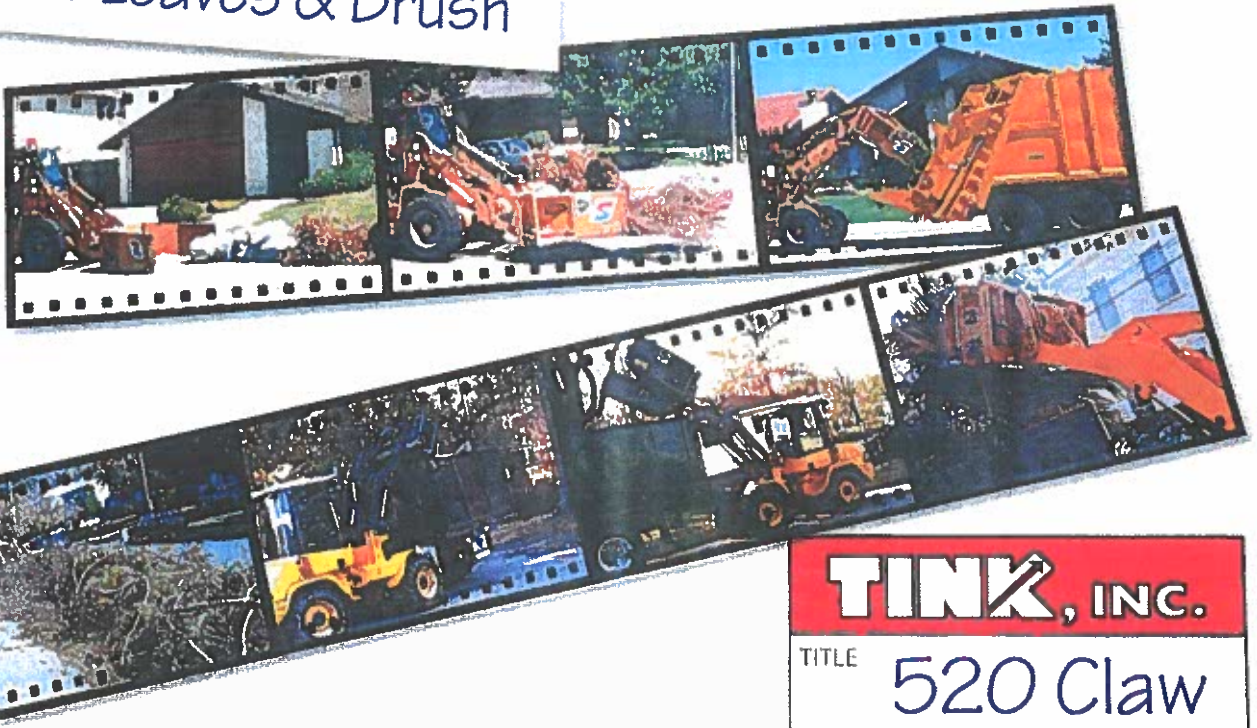

TINK, INC.
TITLE 520 Claw

DESIGN FEATURES

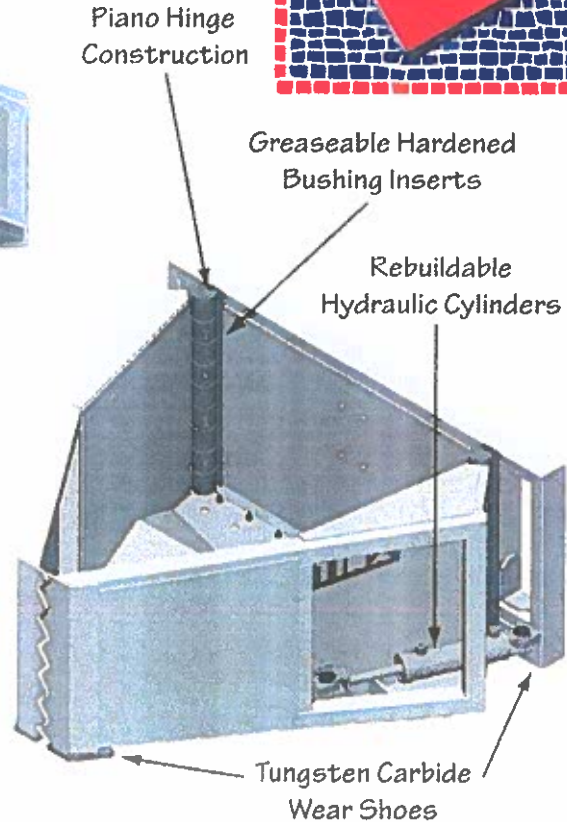
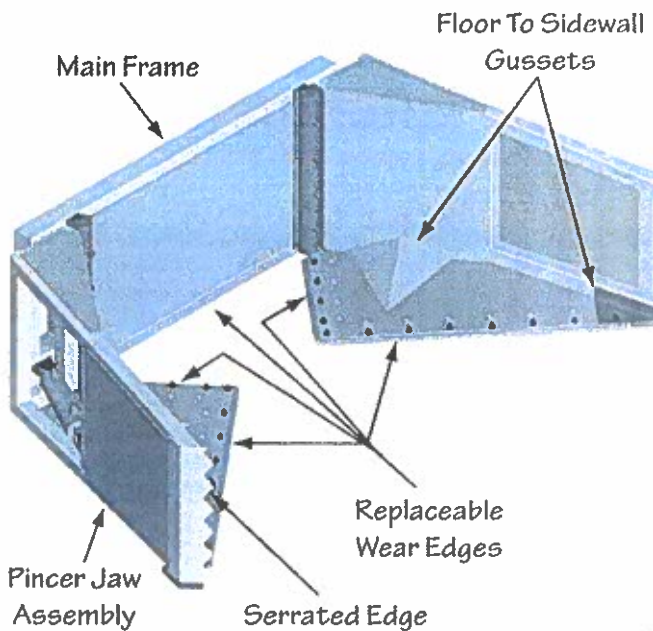

Tink 520 Claw

A special loader bucket that scoops leaves and loose garden waste out of the gutter and into disposal trucks at lower costs. The Claw can be mounted on most $\frac{3}{4}$ to $1\frac{1}{2}$ yard wheel loaders.

The **Pincer Jaw Assembly** is constructed of structural steel tubing welded together to form rigid rectangular frames. The framework is covered and strengthened with steel side panels. The serrated front edges assist in grasping and pinching materials.

Wear Provisions The underside of the Claw, which makes frequent contact with asphalt and other hard surfaces, is equipped with replaceable tungsten carbide wear shoes and hard steel blades that absorb a majority of the abrasion and wear. Tungsten carbide is an extremely hard material that is incorporated into the wear shoes to combine the highest wear and abrasion resistance possible with strength and impact resistance.

Piano-Hinge Construction The pincer jaw assembly is attached to the main frame with a 3 inch diameter piano-hinge that features a $1\frac{1}{2}$ inch pin that won't shear on impact. More importantly the large diameter provides a vast amount of wear surface to promote long lasting life. The hinges include greaseable hardened bushing inserts.

Hydraulic System The rebuildable twin cylinders that open and close the Claw are capable of developing pinch force necessary to grasp and hold materials too long or bulky to fit within the pincer bucket. The cylinders have a 3 inch bore, an 8 inch stroke and a $1\frac{1}{4}$ inch chrome hardened rod. Mechanical stops prevent cylinder damage by not allowing the cylinders to over extend during the Claw's duty cycle.

When the pincer jaws make contact with an immovable object the hydraulic cross over relief valve senses the obstruction a diverts the fluid away from the cylinders. This automatic action minimizes cylinder damage and premature hydraulic system failure.

The flow divider distributes an equal amount of hydraulic fluid to each cylinder ensuring that the pincer jaws operate evenly and simultaneously.

The 520 Claw hydraulic system is designed for machines having 8 to 50 gpm and 1500 to 3800 psi.

Prices and specifications are subject to change without notice.

TINK, Inc. • 2361 Durham Dayton Hwy • Durham CA 95938 • 800-824-4163 • © 2002

TINK CLAW PRICES AND SPECIFICATIONS

The Most Efficient Collection of Leaves and Brush



*Doing business since 1976.
Tink is a name to trust.*

MODEL NUMBER	CUBIC YARD	WIDTH CLOSED	WIDTH OPEN	BACK WALL HEIGHT	MAX LENGTH	SHIP WEIGHT WITH BRACKETS	LIST PRICE WITH BRACKETS
C520	1.2	66"	96"	29"	57"	1725 LBS	\$14,925
C720	2.7	69"	114"	29"	81"	2900 LBS	\$19,100

TINK CLAW SELECTION GUIDE

	TIP LOAD FULL TURN	TIP LOAD STRAIGHT	CLAW MODEL	
100 Category - 1.0 Yard Loader	6,300 lbs.	7,200 lbs.	520	
125 Category - 1.25 Yard Loader	7,800 lbs.	9,000 lbs.	520	
150 Category - 1.50 Yard Loader	9,400 lbs.	10,900 lbs.	520	
175 Category - 1.75 Yard Loader	11,000 lbs.	12,700 lbs.	520	720
200 Category - 2.0 Yard Loader	12,600 lbs.	14,200 lbs.		720
225 Category - 2.25 Yard Loader	14,200 lbs.	16,500 lbs.		720
250 Category - 2.50 Yard Loader	15,700 lbs.	18,200 lbs.		720
275 Category - 2.75 Yard Loader	17,300 lbs.	20,100 lbs.		720

C720 ILLUSTRATIONS

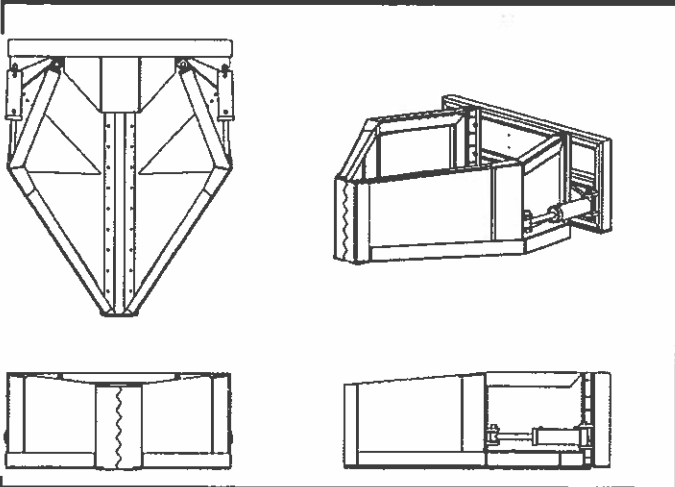

C520 ILLUSTRATIONS

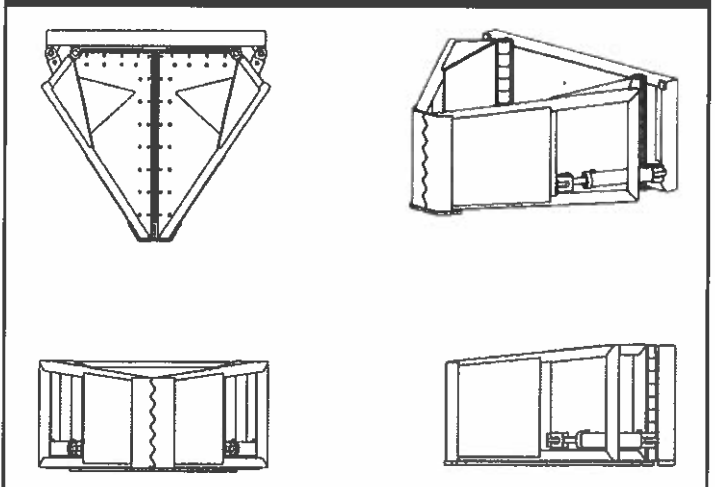

Prices and specifications subject to change without notice. Prices FOB Durham, CA. Effective 1/1/23

Tink, Inc. • Durham, CA • 800-824-4163 • www.tinkinc.com



MULTI-PURPOSE BUCKETS

TWO MODELS FOR EVERY APPLICATION

VERSATILE

Need to be able to grip, grab, pull and lift? Need to grade, doze, or dig and load? If so, your machine deserves a Rockland Multi-Purpose Bucket. These buckets are designed to perform and built to last. They deliver true versatility without changing attachments.

The MP is ideal for utility work and general contractors.

TWO MODELS FOR EVERY APPLICATION

It excavates, loads, and clears land—virtually whatever the job may require.

The MP-L was designed specifically for trash transfer stations. Its ability to crush, pick, sort, and doze really increases trash handling efficiency.

BUILT TO LAST

Both models are built to last in the Rockland tradition. Heavy-duty clams, oversize pivots, and hard alloy wear strips guarantee years of dependable service. Hydraulics are the heart of any multi-purpose bucket and Rockland hydraulics are first-class. High pressure cylinders with special heat-treated, hard chrome-plated rods deliver dependability—year after year. All moldboards are reinforced with box sections and equipped with bolt-on cutting edges and replaceable end bits. Clams can be equipped with bolt-on cutting edges or the teeth of your choice.

This all adds up to versatility, productivity, and dependability. If you are thinking Multi-Purpose buckets, specify Rockland. You will be glad you did!

MP MULTI-PURPOSE

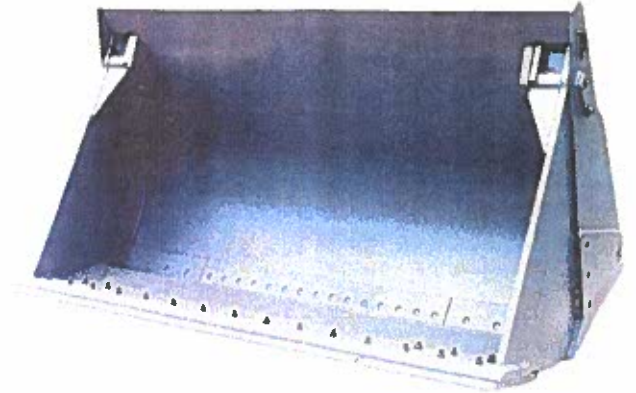

Rockland MP Buckets are ideal for utility work and general contractors.

MP-L TRASH HANDLING

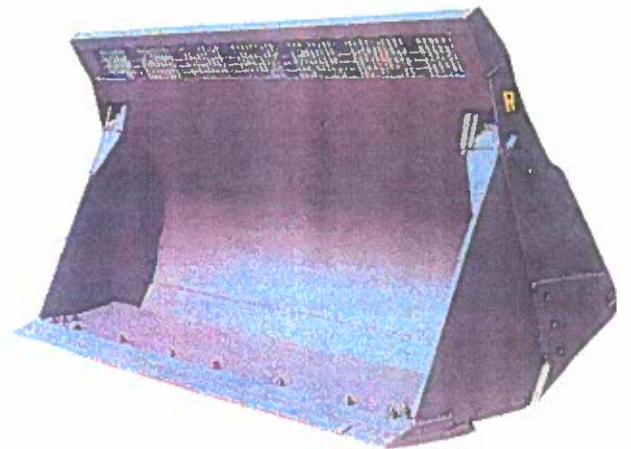

Transfer station operators appreciate the versatility of the Rockland MP-L because of the way it really speeds trash handling.

MP MULTI-PURPOSE

WHEEL LOADER

MACHINE CLASS	5,10		10		10		10,20		20,30		20,30		30,40		40		40,50	
CAPACITY (Yd³)	1	.76	1.25	.96	1.375	1.05	1.5	1.15	1.75	1.34	2	1.53	2.25	1.72	2.5	1.91	2.75	2.1
OAW (")	88	2235	89	2261	95	2413	95	2413	96	2438	96	2438	100	2540	106	2692	106	2692
CEW (")	86.5	2197	87.5	2223	93.5	2375	93	2362	94	2388	94	2388	98	2489	104	2642	104	2642
WEIGHT (lbs.)	1735	787	2045	928	2145	973	2360	1071	3060	1388	3260	1479	3600	1633	3790	1719	4190	1901

MACHINE CLASS	50		50		50,60		60		60		60,70		70		70		80	
CAPACITY (Yd³)	3	2.29	3.25	2.48	3.5	2.68	3.75	2.87	4	3.06	4.25	3.25	4.5	3.44	4.75	3.63	5	3.82
OAW (")	116	2946	116	2946	122	3099	126	3200	132	3353	135	3429	144	3658	144	3658	144	3658
CEW (")	114	2896	114	2896	120	3048	124	3150	130	3302	133	3378	142	3607	142	3607	142	3607
WEIGHT (lbs.)	4500	2041	4900	2223	5380	2440	5480	2486	5680	2576	6110	2772	7275	3300	7775	3527	8575	3890

(mm/kg)

Specifications subject to change without notice.

CRAWLER LOADER

MACHINE CLASS	10		10,20		20		20,30		30		30,40		40		40,50		50	
CAPACITY (Yd³)	1	0.76	1.25	0.96	1.375	1.05	1.5	1.15	1.75	1.34	2	1.53	2.25	1.72	2.5	1.91	2.75	2.1
OAW (")	76	1930	80	2032	84	2134	84	2134	90	2286	92	2337	96	2438	100	2540	100	2540
CEW (")	74	1880	78	1981	82	2083	82	2083	88	2235	90	2286	94	2388	98	2489	98	2489
WEIGHT (lbs.)	1765	801	2395	1086	2595	1177	2795	1268	3360	1524	3615	1640	3855	1749	4300	1950	4655	2112

MACHINE CLASS	50,60		60		60	
CAPACITY (Yd³)	3	2.29	3.25	2.48	3.5	2.68
OAW (")	106	2692	106	2692	110	2794
CEW (")	104	2642	104	2642	108	2743
WEIGHT (lbs.)	5320	2413	5620	2549	6720	3048

(mm/kg)

Specifications subject to change without notice.

MP-L TRASH HANDLING

MP-L Trash Handling Bucket capacity should be determined by the weight of the material usually handled and the operating capacity of the loader. Often a bucket larger than the standard multi-purpose bucket can be used to maximize productivity.

MACHINE CLASS	10		20		20		30		30		40		40		50		50		60	
CAPACITY (Yd³)	2.75	2.1	2.75	2.1	4	3.06	4	3.06	5	3.82	5	3.82	6.75	5.16	6.75	5.16	7.75	5.93	7.75	5.93
OAW (")	96	2438	96	2438	106	2692	106	2692	106	2692	106	2692	120	3048	120	3048	130	3302	130	3302
CEW (")	94	2388	94	2388	104	2642	104	2642	104	2642	104	2642	118	2997	118	2997	128	3251	128	3251
WEIGHT (lbs.)	3295	1495	3760	1706	4090	1855	4490	2037	4900	2223	5465	2479	6000	2722	6380	2894	6755	3064	7530	3416

(mm/kg)

Specifications subject to change without notice.

INSTALLATION INFORMATION

Rockland MP buckets mount in place of the standard bucket using factory pins or specified coupler brackets. The loader must be equipped with a three-spool valve and boom arm piping. MP buckets come complete with jumper hoses to connect to standard boom arm piping.

WARRANTY

Rockland Multi-Purpose Buckets are guaranteed against failure due to defective design, workmanship or materials for a period of two years or 4000 hours.



Distributed by:

ROCKLAND MANUFACTURING CO.
P O BOX 5
BEDFORD, PA 15522
800-458-3773
www.rocklandmfg.com

Haugen

Skid-Steer Pick-up Brooms

877-580-6218

*Pick-up for
Skidsteer Loaders*

26 inch Diameter Brush

*Sweep
forward or reverse*

Optional Gutter Broom

Optional Sprinkler Kit

*Available in 60", 72" and
84" widths*



SPECIFICATIONS

Model	HPB 60	HPB 72	HPB 84
Sweeping Width	63"	75"	87"
Overall Width	70"	82"	94"
Overall Height	28"	28"	28"
Overall Front to Back	65"	65"	65"
Bristle Diameter	26"	26"	26"
Number of Bristles			
Zig-zag	35	40	45
Bristle Material			
(Standard)	Polypropylene	Polypropylene	Polypropylene
(Optional)	Poly/Steel Mix	Poly/Steel Mix	Poly/Steel Mix
Hydraulic Flow Min/Max	15/35	18 / 35	18 / 35
Hydraulic Pressure Max.	3500 Psi	3500 Psi	3500 Psi
Travel Direction	Forward / Reverse	Forward / Reverse	Forward / Reverse
Approximate Weight	995 lbs	1195 lbs	1395 lbs

Marv Haugen Enterprises Inc.

P.O. Box 868 • Casselton, ND 58012 • Phone: 701-347-4827 • Fax: 701-347-4830

Website: www.equipitnow.com • E-mail: haugen@equipitnow.com

Pick-Up Broom Specifications

Model	HPB 60	HPB 72	HPB 84
Overall Width	70"	82"	94"
Sweeping Width	63"	75"	87"
Overall Height	26"	26"	28"
Overall Front to Back	65"	65"	65"
Bristle Diameter	26"	26"	26"
No. of Bristles - Convolute	35	40	45
Bristle Material - Standard	Polypropylene	Polypropylene	Polypropylene
- Optional	Poly/Steel Mix	Poly/Steel Mix	Poly/Steel Mix
Drive System	Hyd. Motor Direct Drive	Hyd. Motor Direct Drive	Hyd. Motor Direct Drive
Hydraulic Flow Min/Max	15/35	18/35	18/35
Hydraulic Pressure Max	3500 PSI	3500 PSI	3500 PSI
Travel Direction	Forward/Reverse	Forward/Reverse	Forward/Reverse
Approximate Weight	995 lbs	1195 lbs	1395 lbs
Optional Water Kit	Available	Available	Available

Pick-Up Broom Dimensions

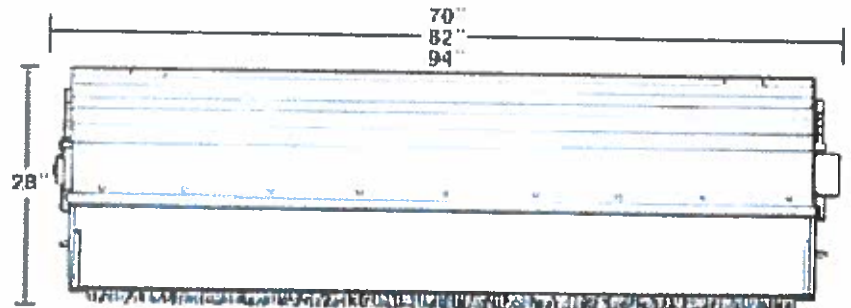
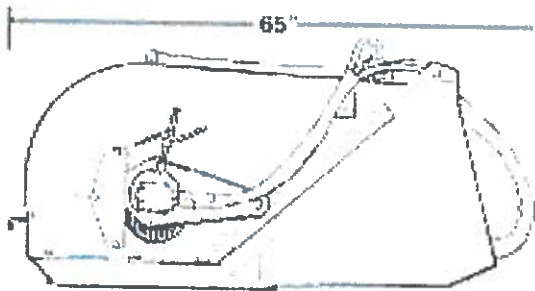

- Designed to be used on 54d steer loaders with 1300 lb or more lifting capacity
- Specifications and designs are subject to change without notice

Haugen

Marv Haugen Enterprises Inc.
 1851 Heartland Ave. - Casselton, ND 58012
Toll Free 877-580-6218
 Phone: 701-347-4827 Fax: 701-347-4830
 Website: www.haugenattachments.com
 Email: haugen@equipitnow.com



GSWA PROCUREMENT RECORD Page 233
GUAM SOLID WASTE AUTHORITY



LOURDES A. LEON GUERRERO
 Superintendent of Operations

JOSHUA F. TENORIO
 Director of Administration

IRVIN L. SLIKE
 General Manager

November 27, 2023

INVITATION FOR BID
GSWA-004-24
COMPACT WHEEL LOADER W/ ATTACHMENTS

AMENDMENT NO. 3

1. Amend page 31 of 34

From:

Bid Due Date & Bid Opening at the Guam Solid Waste
 Authority: Administration Office, GSWA Bldg., 2nd Fl.
 546 N. Marine Corps Dr., Tamuning, Guam

Tuesday, November 28, 2023
 at 1:00PM
 Chamorro Standard Time

To Now Read:

Bid Due Date & Bid Opening at the Guam Solid Waste
 Authority: Administration Office, GSWA Bldg., 2nd Fl.
 546 N. Marine Corps Dr., Tamuning, Guam

Tuesday, December 5, 2023
 at 1:00PM
 Chamorro Standard Time

*All others remain the same.

Irvin L. Slike,
 General Manager

ACKNOWLEDGEMENT RECEIPT	
Return to GSWA by email or fax.	
Received By:	<i>Ryne-Paul Santos</i>
Date:	<i>11/20/23</i>
Company Name:	<i>Far East Equipment Co. LLC</i>
Fax to: 671 649 3777	
Email: procurement@gswa.guam.gov	



GSWA PROCUREMENT RECORD Page 234
GUAM SOLID WASTE AUTHORITY



LOURDES A. LEON GUERRERO
Secretary of Finance

JOSHUA F. TENORIO
Secretary of Land

IRVIN L. SLIKE
General Manager

November 20, 2023

INVITATION FOR BID
GSWA-004-24
COMPACT WHEEL LOADER W/ ATTACHMENTS
AMENDMENT NO. 2

1. Amend page 31 of 34

From:

Deadline for Receipt of Written Questions must be e-mailed to the Guam Solid Waste Authority at procurement@gswa.guam.gov , ATTN: General Manager	Wednesday, November 15, 2023 on or before 5:00PM Chamorro Standard Time
--	---

To Now Read:

Deadline for Receipt of Written Questions must be e-mailed to the Guam Solid Waste Authority at procurement@gswa.guam.gov , ATTN: General Manager	Tuesday, November 21, 2023 on or before 5:00PM Chamorro Standard Time
--	---

2. Amend page 31 of 34

From:

Bid Due Date & Bid Opening at the Guam Solid Waste Authority: Administration Office, GSWA Bldg., 2 nd Fl. 546 N. Marine Corps Dr., Tamuning, Guam	Wednesday, November 22, 2023 at 1:00PM Chamorro Standard Time
--	---

To Now Read:

Bid Due Date & Bid Opening at the Guam Solid Waste Authority: Administration Office, GSWA Bldg., 2 nd Fl. 546 N. Marine Corps Dr., Tamuning, Guam	Tuesday, November 28, 2023 at 1:00PM Chamorro Standard Time
--	---

3. Amend to replace pages 32 of 34 through 34 of 34 with the "Revised 11/20/2023 Page 32" through "Revised 11/20/2023 Page 34" attached.

*All others remain the same.

Irvin L. Slike,
 General Manager

ACKNOWLEDGEMENT RECEIPT	
Return to GSWA by email or fax.	
Received by	<i>Ryne Paul Santos</i>
Date:	<i>11/20/23</i>
Company Name	<i>Far East Equipment Co. LLC</i>
Fax to: 671 649 3777	
Email: procurement@gswa.guam.gov	



GUAM SOLID WASTE AUTHORITY

LOURDES A. LEON GUERRERO
Governor of Guam

JOSHUA TENOREO
Lt. Governor of Guam

IRVIN L. SLIKE
General Manager



ITEM NO.	DESCRIPTION	QTY	UOM	UNIT PRICE	PRICE EXTENSION
1.0	Compact Wheel Loader w/ Attachments	1	EA	\$ _____	\$ _____

SPECIFICATIONS:

Indicate on each line of the technical specifications whether or not each item complies with the specification or an exception is being taken. If additional space is required to fully explain bid exceptions, attach additional typed page(s) to the bid submittal indicating the section number and subsection that has the exception, and provide explanation.

COMPLY / NON-COMPLY

Engine:

Gross HP at 2400 RPM: 73 HP minimum

Peak Torque at 1560 RPM: 206 foot lbs. minimum

Emissions: Compliant with EPA Final Tier 4/EU Stage V

Four cylinders

Powertrain:

Hydrostatic with infinitely variable speed control over full range of operating speeds. 2 speed ranges, joystick mounted F-N-R, acceleration pedal.

Axes: Fixed, 100% differential, manually engaged front axle, fixed conventional differential rear axle or oscillating rear axle

Max rise and fall single wheel: 15 inches maximum, 14 inch minimum

Hydraulically activated, self-adjusting internal wet disc brakes and driveline drum brake

Cooling:

Hydraulically driven, proportionally controlled fan or belt-driven fan

Articulation Angle: 30 degrees each direction

Cylinders: Heat treated chrome plated polished cylinder rods, hardened steel, replaceable bushings and pivot pins

Hydraulics:

Main pump (loader and steering): 18 GPM standard, 29 GPM with high flow option.

Quick Coupling: Conforms with ISO 16028 quick coupling for all attachments

Electrical:

Voltage: 12-volt or 24-volt electrical system

Battery: One (1) 24-volt or two (2) 12-volt

Battery capacity: One (1) 925 CCA or Two (2) 900 CCA

Cab:

Seat: Air ride high back with head rest and dual lumbar support or mechanical suspension seat

Noise: Operator ear 70 dBA, Bystander 101 dBA



GUAM SOLID WASTE AUTHORITY



LOURDES A. LEON GUERRERO
Governor of Guam

TOSHUA F. TENORIO
Deputy Governor of Guam

IRVIN L. SLIKE
General Manager

COMPLY / NON-COMPLI

Air conditioning

Steering: Dual tilt and telescoping steering column

Performance: Conforms with SAE J1040, SAE J231, ISO 3471 and ISO 3449 ROPS/FOPS

Operating Weight:

ISO quick coupler and 1CY general purpose bucket / bolt on edge 12,250 lbs. minimum

1.4 CY multi-purpose bucket: 12,800 lbs. maximum

Wheelbase: 7 feet minimum

Dump clearance: 40-degree full height – 8 feet 3 inches

Reach: 40-degree full height – 32 inches

Fork height fully raised: 10 feet minimum

Fork tipping load straight: 7000 lb. maximum

Attachments:

ISO quick coupling mechanism: Conforms with ISO 16028

One (1) additional 1.4 CY bucket with bolt on edge

One (1) Tink claw bucket model 520 or equal

One (1) 60-inch pick-up broom: 800 lb. minimum; 900 lb. max

One (1) Fork: 48 inches minimum

Equipment Warranty:

The Bidder guarantees to the Purchaser that the equipment, upon delivery, will be brand new and will have been constructed using entirely new components. Furthermore, the Bidder assures that any new equipment provided shall be free from any defects in manufacturing workmanship and materials for a duration of 24 months or 2,000 hours, whichever occurs first, commencing from the date of equipment delivery. This warranty encompasses any necessary repairs or replacements without any additional cost to the Purchaser.

Miscellaneous Items:

One (1) operator's manual hardcopy

One (1) operator's manual on CD

One (1) complete illustrated parts book

One (1) shop repair manual

One (1) warranty manual

Manufacturer's training of GSWA crew (8 hours) & contracted mechanics (20 hours)

Online manual for parts, service & repair



GUAM SOLID WASTE AUTHORITY



LOURDES A. LEON GUERRERO
Governor of Guam

JOSHUA F. TENORIO

TRVIN L. SLIKE
General Manager

Delivered with a full tank of fuel

Note: The GSA Federal Contract will be considered along with its terms and conditions if offered.

Bidding On:

Manufacturer: _____

Year: _____

Model: _____

Place of Origin: _____

Date of Delivery: _____

Date/Time 11-22-2023 01:14:18 p.m. Transmit Header Text
Local ID 1 6714734370 Local Name 1 PUI

This document : Confirmed
(reduced sample and details below)
Document size : 8.5"x11"



GUAM SOLID WASTE AUTHORITY

LOURDES A. LEON GUERRERO
Governor of Guam

JOSHUA P. TENORIO
Governor of Guam

IRVIN L. SLIKE
General Manager



November 20, 2023

**INVITATION FOR BID
GSWA-004-24**

COMPACT WHEEL LOADER W/ ATTACHMENTS

AMENDMENT NO. 2

1. Amend page 31 of 34

From:
Deadline for Receipt of Written Questions **Wednesday, November 15, 2023**
must be e-mailed to the Guam Solid Waste Authority at **on or before 5:00PM**
procurement@gswa.guam.gov, ATTN: General Manager **Chamorro Standard Time**

To Now Read:
Deadline for Receipt of Written Questions **Tuesday, November 21, 2023**
must be e-mailed to the Guam Solid Waste Authority at **on or before 5:00PM**
procurement@gswa.guam.gov, ATTN: General Manager **Chamorro Standard Time**

2. Amend page 31 of 34

From:
Bid Due Date & Bid Opening at the Guam Solid Waste **Wednesday, November 22, 2023**
Authority: Administration Office, GSWA Bldg., 2nd Fl. **at 1:00PM**
546 N. Marine Corps Dr., Tamuning, Guam **Chamorro Standard Time**

To Now Read:
Bid Due Date & Bid Opening at the Guam Solid Waste **Tuesday, November 28, 2023**
Authority: Administration Office, GSWA Bldg., 2nd Fl. **at 1:00PM**
546 N. Marine Corps Dr., Tamuning, Guam **Chamorro Standard Time**

3. Amend to replace pages 32 of 34 through 34 of 34 with the "Revised 11/20/2023 Page 32" through "Revised 11/20/2023 Page 34" attached.

*All others remain the same.

Irvin L. Slike
Irvin L. Slike,
General Manager

ACKNOWLEDGEMENT RECEIPT	
Return to GSWA by original or fax.	
Received by:	<i>Ryan Paul Santos</i>
Date:	<i>11/20/23</i>
Company Name:	<i>Forrest Equipment Co. LLC</i>
Fax to: 671 649 3777	
Email: procurement@gswa.guam.gov	

546 N. MARINE CORPS DRIVE, TAMUNING, GU 96913 * TEL: 671-646-3111 | FAX: 671-649-3777
<https://www.guamsolidwasteauthority.com/>

Total Pages Scanned : 4

Total Pages Confirmed : 4

No.	Job	Remote Station	Start Time	Duration	Pages	Line	Mode	Job Type	Results
001	306	6716493777	01:12:52 p.m. 11-22-2023	00:00:49	4/4	1	EC	HS	CP28800

Abbreviations:

HS: Host send	PL: Polled local	MP: Mailbox print	CP: Completed	TS: Terminated by system
HR: Host receive	PR: Polled remote	RP: Report	FA: Fail	G3: Group 3
WS: Waiting send	MS: Mailbox save	FF: Fax Forward	TU: Terminated by user	EC: Error Correct



November 20, 2023

**INVITATION FOR BID
GSWA-004-24
COMPACT WHEEL LOADER W/ ATTACHMENTS**

Questions and Concerns received from Morrigo Equipment on November 15, 2023

1. Axles: Fixed, 100% differential, manually engaged front axle, fixed conventional differential rear axle. Is an oscillating rear axle acceptable?

Response: Yes, refer to Amendment No. 2.

2. Max rise and fall single wheel: 15 inches maximum, 14 inches minimum. Please clarify what is required by the term listed above.

Response: The term "Max rise and fall single wheel: 15 inches maximum, 14 inches minimum" pertains to the vertical movement capability of a single wheel on the compact wheel loader. Here's a breakdown of the requirement:

- **Max Rise:** This refers to the maximum vertical distance the center of a single wheel is allowed to move upward from its resting position. In this context, the specified maximum rise is 15 inches.
- **Min Fall:** Conversely, the minimum fall denotes the minimum vertical distance the center of a single wheel is permitted to move downward from its resting position. For this specification, the minimum fall is 14 inches.

These parameters are crucial for ensuring that the compact wheel loader can effectively navigate varied terrains, accommodate different load sizes, and maintain stability during operation.

3. Hydraulically Driven, proportionally controlled fan. Will a belt driven fan be acceptable?

Response: Yes, refer to Amendment No. 2.

4. Voltage: 12-volt. Will a 24 Volt Electrical System be acceptable?

Response: Yes, refer to Amendment No. 2.

5. One (1) Battery. Will two 12-volt batteries be acceptable?

Response: Yes, refer to Amendment No. 2.

6. Battery Capacity: 925 CCA. Will two batteries with 900 CCA be acceptable?

Response: Yes, refer to Amendment No. 2.



GUAM SOLID WASTE AUTHORITY

LOURDES A. LEON GUERRERO
Governor of Guam

JOSHUA F. TENORIO
Lieutenant Governor

IRVIN L. SLIKE
General Manager



7. Seat: Air Ride high back with head rest and dual lumbar support. Will a mechanical suspension seat be acceptable?

Response: Yes, refer to Amendment No. 2.

8. 1.4 CY Bucket: 12,800 lbs. Maximum. Please confirm if this bucket request is for a multipurpose bucket.

Response: Refer to Amendment No. 2.

9. One (1) 1.4 CY Bucket with Bolt on Cutting Edge. Please confirm if this bucket request is for a Multipurpose Bucket. Please confirm if this is bucket request is additional to Question 8 bucket request or the same request.

Response: Refer to Amendment No. 2.

Questions and Concerns received from Far East Equipment Co. on November 17, 2023

10. The manufacturer of the Tink Claw bucket does not recommend the C720 (2.7CYD) model for this size machine. They recommend the C520 (1.2CYD) model for a machine of this size. With this information, does GSWA want to proceed with a C720 model bucket though it may pose a tipping hazard?

Response: No, refer to Amendment No. 2.

Irvin L. Slike,
General Manager

ACKNOWLEDGEMENT RECEIPT	
Return to GSWA by email or fax.	
Received By	Ryne Paul Santos
Date:	11/22/23
Company Name	Far East Equipment Co. LLC
Fax to: 671 649 3777	
Email: procurement@gswa.guam.gov	

Date/Time 11-22-2023 01:13:02 p.m. Transmit Header Text
Local ID 1 6714734370 Local Name 1 PUI

This document : Confirmed
(reduced sample and details below)
Document size : 8.5"x11"



GUAM SOLID WASTE AUTHORITY

LOURDES A. LEON GUERRERO
Governor of Guam

JOSHUA F. TENORIO
Lt. Governor of Guam

IRVIN L. SUAREZ
Deputy Director



November 20, 2023

INVITATION FOR BID
GSWA-004-24

COMPACT WHEEL LOADER W/ ATTACHMENTS

Questions and Concerns received from Morrico Equipment on November 15, 2023

1. Axles: Fixed, 100% differential, manually engaged front axle, fixed conventional differential rear axle. Is an oscillating rear axle acceptable?

Response: Yes, refer to Amendment No. 2.

2. Max rise and fall single wheel: 15 inches maximum, 14 inches minimum. Please clarify what is required by the term listed above.

Response: The term "Max rise and fall single wheel: 15 inches maximum, 14 inches minimum" pertains to the vertical movement capability of a single wheel on the compact wheel loader. Here's a breakdown of the requirement:

- **Max Rise:** This refers to the maximum vertical distance the center of a single wheel is allowed to move upward from its resting position. In this context, the specified maximum rise is 15 inches.
- **Min Fall:** Conversely, the minimum fall denotes the minimum vertical distance the center of a single wheel is permitted to move downward from its resting position. For this specification, the minimum fall is 14 inches.

These parameters are crucial for ensuring that the compact wheel loader can effectively navigate varied terrains, accommodate different load sizes, and maintain stability during operation.

3. Hydraulically Driven, proportionally controlled fan. Will a belt driven fan be acceptable?

Response: Yes, refer to Amendment No. 2.

4. Voltage: 12-volt. Will a 24 Volt Electrical System be acceptable?

Response: Yes, refer to Amendment No. 2.

5. One (1) Battery. Will two 12-volt batteries be acceptable?

Response: Yes, refer to Amendment No. 2.

6. Battery Capacity: 925 CCA. Will two batteries with 900 CCA be acceptable?

Response: Yes, refer to Amendment No. 2.

546 N. MARINE CORPS DRIVE, TAMUNING, GU 96913 * TEL: 671-646-3111 | FAX: 671-649-3777
<https://www.guamsolidwasteauthority.com/>

Total Pages Scanned : 2

Total Pages Confirmed : 2

No.	Job	Remote Station	Start Time	Duration	Pages	Line	Mode	Job Type	Results
001	305	6716493777	01:12:10 p.m. 11-22-2023	00:00:27	2/2	1	EC	HS	CP28800

Abbreviations:

HS: Host send
HR: Host receive
WS: Waiting send
PL: Polled local
PR: Polled remote
MS: Mailbox save
MP: Mailbox print
RP: Report
FF: Fax Forward
CP: Completed
FA: Fail
TU: Terminated by user
TS: Terminated by system
G3: Group 3
EC: Error Correct



November 14, 2023

**INVITATION FOR BID
 GSWA-004-24
 COMPACT WHEEL LOADER W/ ATTACHMENTS**

AMENDMENT NO. 1

1. Amend page 31 of 34

From:

Deadline for Receipt of Written Questions
 must be e-mailed to the Guam Solid Waste Authority at
procurement@gswa.guam.gov, ATTN: General
 Manager

Thursday, November 9, 2023
 on or before 5:00PM
 Chamorro Standard Time

To Now Read:

Deadline for Receipt of Written Questions
 must be e-mailed to the Guam Solid Waste Authority at
procurement@gswa.guam.gov, ATTN: General
 Manager

Wednesday, November 15, 2023
 on or before 5:00PM
 Chamorro Standard Time

2. Amend page 31 of 34

From:

Bid Due Date & Bid Opening at the Guam Solid Waste
 Authority: Administration Office, GSWA Bldg., 2nd Fl.
 546 N. Marine Corps Dr., Tamuning, Guam

Monday, November 20, 2023
 at 1:00PM
 Chamorro Standard Time

To Now Read:

Bid Due Date & Bid Opening at the Guam Solid Waste
 Authority: Administration Office, GSWA Bldg., 2nd Fl.
 546 N. Marine Corps Dr., Tamuning, Guam

Wednesday, November 22, 2023
 at 1:00PM
 Chamorro Standard Time

*All others remain the same.

Irvin L. Slike,
 General Manager

ACKNOWLEDGEMENT RECEIPT	
Return to GSWA by email or fax	
Received By	Ryne Paul Santos
Date	11/14/23
Company Name	Far East Equipment Co. LLC
Fax to: 671-649-3777	
Email: procurement@gswa.guam.gov	



GUAM SOLID WASTE AUTHORITY

LOURDES A. LEON GUERRERO
Supervisor of Finance

JOSHUA F. TENORIO
Supervisor of Operations

IRVIN L. SLIKE
General Manager



November 14, 2023

INVITATION FOR BID GSWA-004-24 COMPACT WHEEL LOADER W/ ATTACHMENTS

Questions and Concerns received from Far East Equipment Co. On November 13, 2023

1. In regards to the high-flow hydraulics requirement for the broom attachment, John Deere's broom attachment does "NOT" require high-flow. Will high-flow still be required?

Response: The hydraulic flow range is typical for brooms.

2. What make and model machine was used to form the specs of this bid?

Response: John Deere model 244P.

Irvin L. Slike,
General Manager

ACKNOWLEDGEMENT RECEIPT	
Return to GSWA by email or fax.	
Received By	Ryne-Paul Santos
Date	11/14/22
Company Name	Far East Equipment Co. LLC
Fax to: 671 649 3777	
Email: procurement@gswa.guam.gov	



GUAM SOLID WASTE AUTHORITY

LOURDES A. LEON GUERRERO
Governor of Guam

JOSHUA F. TENORIO
Lt. Governor of Guam

IRVIN L. SLIKE
General Manager



November 13, 2023

INVITATION FOR BID GSWA-004-24 COMPACT WHEEL LOADER W/ ATTACHMENTS

Questions and Concerns received from Far East Equipment Co. On November 9, 2023

1. In the specs under Powertrain, the spec reads "Max rise and fall single wheel: 15 inch maximum, 14 inch minimum." Will 10 inches be acceptable?

Response: No, specs remain the same.

2. In the specs under Cooling, the spec reads "Hydraulically driven, proportionally controlled fan." Will direct driven be acceptable?

Response: No, specs remain the same.

3. In the specs under Hydraulics, the spec reads "Main pump (loader and steering): 18 GPM standard, 29 GPM with high flow option." Will a max rated flow 21.13 GPM @ 1,000 PSI be acceptable?

Response: No, specs remain the same.

4. In the specs under Hydraulics, the spec reads "Main pump (loader and steering): 18 GPM standard, 29 GPM with high flow option." Can you clarify why there is a request for high flow option when the requested documents do not require high flow hydraulics?

Response: The pick-up broom specified requires the flow specified.

5. In the specs under Electrical, the spec reads "Battery capacity: 925 CCA." Will 830 CCA be acceptable?

Response: No, specs remain the same.

Irvin L. Slike,
General Manager

ACKNOWLEDGEMENT RECEIPT	
Return to GSWA by email or fax.	
Received By:	Ryno-Paul Santos <i>[Signature]</i>
Date:	11/13/23
Company Name:	Far East Equipment Co. LLC
Fax to: 671 649 3777	
Email: procurement@gswa.guam.gov	

BID ANALYSIS



GUAM SOLID WASTE AUTHORITY

LOURDES A. LEON GUERRERO
Governor of Guam

JOSHUA F. TENORIO
Lt. Governor of Guam

IRVIN L. SLIKE
General Manager



December 12, 2023

MEMORANDUM

To: Irvin L. Slike, General Manager
From: Alicia Fejeran, Chief of Administration
Subject: Invitation for bid GSWA004-24, Compact Wheel Loader with Attachments

The bid opening took place as scheduled on December 5, 2023, at 1:00 PM, and there were a total of four registered prospective bidders who acquired the bid documents. Only two bids were submitted, which was Far East Equipment and Morrigo Equipment.

ITEM NO.	DESCRIPTION	QTY	UOM	FAR EAST EQUIP 2024 JOHN DEERE 244P		MORRICO 2024 CASE/PALADIN/WERK BRAU/TINK INC. 221F/QB961L/WBLH92125/C520/21560	
				UNIT PRICE	PRICE EXT.	UNIT PRICE	PRICE EXT.
1	Compact Wheel Loader with Attachments	1	EA	\$227,261.18	\$227,261	\$180,557.00	\$180,557.00

While Morrigo Equipment submitted the lower bid, a detailed analysis reveals significant deviations from the specifications outlined in the Invitation for Bid (IFB). The IFB requires specific equipment specifications, and Morrigo Equipment's proposal deviates in the following key areas:

1. IFB Requirements: Max rise and fall single wheel: 15 inch max, 14 inch min.
 - a. Morrigo offers a Rise and Fall single wheel of 11.8 inches.
 - b. GSWA clarified that this specification would not be changed in Q&C dated 11/13/23.
2. IFB Requirements: Hydraulically driven, proportionatly controlled fan or belt-driven fan
 - a. Morrigo Deviation: Fan directly connected to the engine.
 - b. GSWA clarified that direct driven will no tbe acceptable in Q&C dated 11/13/23
3. IFB Requirements: 1.4CY multipurpose bucket. 12,800 lbs maximum
 - a. Morrigo Deviation: 1.38 CY Multipurpose bucket
4. IFB Requirements: One (1) 60-inch pick up broom: 800lbs min, 900 lbs max.
 - a. Morrigo Deviation: 946lbs pick up sweeper

Additionally, the bid offer was provided to the Superintendent and he confirmed that specification deviations were not acceptable.

The Morrigo Bid, although lower in price, does not meet specifications required. Therefore, it is recommended that award be made to Far East Equipment due to meeting all requirements and price is within GSWA budget.



GUAM SOLID WASTE AUTHORITY

LOURDES A. LEON GUERRERO
Governor of Guam

JOSHUA F. TENORIO
Lt. Governor of Guam

IRVIN L. SLIKE
General Manager



Your approval is hereby requested.

Approved Disapproved

12/12/23
Date

Irvin L. Slike
General Manager

BID ABSTRACT

2

Number of Bids Received **2**
 Description of Supplies or Services
COMPACT WHEEL LOADER W/ ATTACHMENTS



ABSTRACT OF BIDS

Invitation Number **GSWA-004-24**
 Opening Date **12/05/2023**
 Time **1:00PM**

OFFEROR	Acceptance Time	Delivery Acceptance	Delivery Specified in IFB (Days)	A	B	C	D	E	F	G	H	I	ITEM / DESCRIPTION	QTY. UNIT	UNIT PRICE	TOTAL PRICE
MORRIS Equipment				✓	✓	✓	✓	✓	✓	✓	✓	✓	10 COMPACT wheel loader w/ attachments.	1	18957.00	18957.00
* CAP. OF AUTHORITY													ONE/PAK/IN			
* SPEC. MEASURES													WRE PAV			
													TRK INC			
													W/F/007/11/4			
													W/SLH/9/25/7			
													/CSLD			
													21500			
													200 Days MKO			

LEGENDS

- A. Affidavit Disclosing Ownership, Influence, Commissions & Conflict of Interest
- B. Affidavit re: Ethical Standards
- C. Affidavit re: No Gratuities or Kickbacks
- D. Special Provision Restriction Against Sexual Offenders
- E. Declaration re: Compliance with US DOL Wage Determination
- F. Affidavit re: Non-Collusion
- G. Affidavit re: Contingent Fees
- H. Bid Bond
- I. Business License

I hereby certify that all bids are received in response to this invitation were opened under my personal supervision and that the same as of all bidders have been entered hereon.

Signature

Date

Tabulated By

BID STATUS



GUAM SOLID WASTE AUTHORITY

LOURDES A. LEON GUERRERO
Governor of Guam

JOSHUA F. TENORIO
Lt. Governor of Guam

IRVIN SLIKE
General Manager



BID STATUS

MORRICO EQUIPMENT
Attn: Paul Eustaquio
197 Ypao Rd.
Tamuning, Guam 96913
paul@morricoequipment.com
(671) 483-0180

BID INVITATION NO.: GSWA-004-24

OPENED: December 5, 2023

DESCRIPTION: COMPACT WHEEL LOADER W/ ATTACHMENTS

The following is the result of the above-mentioned bid. Refer to the items checked below.

- Cancelled (in its entirety), or partially cancelled due to:
 - Insufficient funds;
 - Change of specifications; or
 - Insufficient number of bidders
- Rejected due to:
 - Late submission of bid;
 - No bid security or insufficient bid security amount submitted; as required by section 11 of the General Terms and Conditions;
 - Not meeting the delivery requirements stated in the IFB;
 - Non-conformance with the specifications;
 - Inability to provide future maintenance and services equipment;
 - High price; or
 - Others

REMARKS: _____

Bid is recommended for award to: **FAR EAST EQUIPMENT CO., LLC.**

Thank you for your participation. Please send your authorized representative to pick up your original bid status and Cashier's Check, Letter of Credit, and/or Surety Bond.

ACKNOWLEDGEMENT RECEIPT	
Return to GSWA by email or fax	
Received By	<u>Paul Eustaquio</u>
Date	<u>12/13/23</u>
Company Name	<u>Morrigo Equipment</u>
Fax to: 671 649-3777	
Email: procurement@gswa.guam.gov	



IRVIN L. SLIKE,
General Manager



GUAM SOLID WASTE AUTHORITY

LOURDES A. LEON GUERRERO
Governor of Guam

JOSHUA F. TENORIO
Lt. Governor of Guam

IRVIN SLIKE
General Manager



December 15, 2023

BID STATUS

MORRICO EQUIPMENT
Attn: Paul Eustaquio
197 Ypao Rd.
Tamuning, Guam 96913
paul@morricequipment.com
(671) 483-0180

BID INVITATION NO.: GSWA-004-24

OPENED: December 5, 2023

DESCRIPTION: COMPACT WHEEL LOADER W/ ATTACHMENTS

The following is the result of the above-mentioned bid. Refer to the items checked below.

- Cancelled (in its entirety), or partially cancelled due to:
 - Insufficient funds;
 - Change of specifications; or
 - Insufficient number of bidders
- Rejected due to:
 - Late submission of bid;
 - No bid security or insufficient bid security amount submitted; as required by section 11 of the General Terms and Conditions;
 - Not meeting the delivery requirements stated in the IFB;
 - Non-conformance with the specifications;
 - Inability to provide future maintenance and services equipment;
 - High price; or
 - Others

REMARKS: Deviation from bid specifications are non-compliant. Requirement of bid "Max rise and fall single wheel: 15-inch maximum, 14-inch minimum"; Offered: rise and fall single wheel of 11.8 inches. Requirement of bid: "Hydraulically driven, proportionally controlled fan or belt-driven fan"; Offered: Fan directly connected to engine. Requirement "1.4CY multi-purpose bucket. 12,800 lbs. maximum"; Offered: 1.38CY multi-purpose bucket. Requirement of bid "One (1) 60-inch pick-up broom: 800lbs. minimum, 900lbs. maximum"; Offered: 946lbs. pick-up sweeper.

Bid is recommended for award to: **FAR EAST EQUIPMENT CO., LLC.**

Thank you for your participation. Please send your authorized representative to pick up your original bid status and Cashier's Check, Letter of Credit, and/or Surety Bond.



IRVIN L. SLIKE,
General Manager

ACKNOWLEDGEMENT RECEIPT	
Return to GSWA by email or fax.	
Received By	<i>Paul Eustaquio</i>
Date	<i>12/19/23</i>
Company Name	<i>Morrice Equipment</i>
Fax to: 671 649 3777	
Email: procurement@gswa.guam.gov	

**MEMORANDUM OF
EVALUATIONS &
NEGOTIATIONS
N/A**

**NOTICE OF INTENT
OF POSSIBLE
AWARD**



GUAM SOLID WASTE AUTHORITY

LOURDES A. LEON GUERRERO

JOSHUA F. TENORIO

IRVIN L. SLIKE



December 13, 2023

FAR EAST EQUIPMENT CO., LLC
Attn: John Limtiaco
17-3311 Corsair Rd.
Tiyán Barrigada, Guam 96913
jlimtiaco@fareastequipment.com
(671) 888-6270

RE: NOTICE OF INTENT OF POSSIBLE AWARD
GSWA-004-24: COMPACT WHEEL LOADER W/ ATTACHMENTS

Håfa Adai, Mr. Limtiaco,

As a result of our bid analysis on the above referenced bid number, your bid submission for Compact Wheel Loader w/ Attachments is being considered for award.

Barring any formal protest lodged, a purchase order will be issued 14 days from the date of this notice. Should there be any formal protest received, Guam Solid Waste Authority will accompany with the Stay of Procurement and there will be no further action until the protest is resolved.

Thank you for your participation with this bid. If you have any questions, please contact Alicia Fejeran at (671) 647-4312 or email AliciaFejeran@gswa.guam.gov.

Sincerely,

Irvin L. Slike,
General Manager

ACKNOWLEDGEMENT RECEIPT	
Return to GSWA by email or fax	
Received By	Marisa Reyes
Date	12/14/23
Company Name	Far East Equipment Co., LLC
Fax to: 671 649 3777	
Email: procurement@gswa.guam.gov	



GUAM SOLID WASTE AUTHORITY



LOURDES A. LEON GUERRERO
Governor of Guam

JOSHUA F. TENORIO
Lt. Governor of Guam

IRVIN L. SLIKE
General Manager

December 13, 2023

FAR EAST EQUIPMENT CO., LLC
Attn: John Limtiaco
17-3311 Corsair Rd.
Tiyán Barrigada, Guam 96913
jlimtiaco@fareastequipment.com
(671) 888-6270

RE: NOTICE OF INTENT OF POSSIBLE AWARD
GSWA-004-24: COMPACT WHEEL LOADER W/ ATTACHMENTS

Háfa Adai, Mr. Limtiaco,

As a result of our bid analysis on the above referenced bid number, your bid submission for Compact Wheel Loader w/ Attachments is being considered for award.

Barring any formal protest lodged, a purchase order will be issued 14 days from the date of this notice. Should there be any formal protest received, Guam Solid Waste Authority will accompany with the Stay of Procurement and there will be no further action until the protest is resolved.

Thank you for your participation with this bid. If you have any questions, please contact Alicia Fejeran at (671) 647-4312 or email Alicia.fejeran@gswa.guam.gov.

Sincerely,

Irvin L. Slike,
General Manager

ACKNOWLEDGEMENT RECEIPT	
Return to GSWA by email or fax.	
Received By	Marisa Reyes
Date	12/14/23
Company Name	Far East Equipment Co. LLC
Fax to: 671-649-3777	
Email: procurement@gswa.guam.gov	

COMMUNICATION LOG

COMMUNICATION LOG					PROJECT: GSWA-004-24 COMPACT WHEEL LOADER W/ ATTACHMENTS	
DATE	TIME	ENTERED BY	ITEM / REFERENCE	PARTIES	TOPIC / SUBJECT / COMMENT	
8/28/2023	10:53	CAGUON	EMAIL	IRVIN SLIKE, GSWA PROCUREMENT, ROMAN PEREZ, DENNIS MENDIOLA	FORMATTING OF SPEC SHEET FOR COMPACT WHEEL LOADER	
10/11/2023	11:21	CAGUON	EMAIL	IRVIN SLIKE, GSWA PROCUREMENT, ALICIA FEJERAN, KATHRINE KAKIGI	REQUEST TO PUT OUT INVITATION FOR BID	
10/16/2023	17:10	CAGUON	EMAIL	GSWA PROCUREMENT, ROMAN PEREZ, DENNIS MENDIOLA, JULIE CRUZ, ALICIA FEJERAN, KEILANI MESA	SPEC SHEET FOR APPROVAL & SIGNATURE	
10/18/2023	12:14	CAGUON	EMAIL	GSWA PROCUREMENT, RAYMOND BAMBA (GSA), ALICIA FEJERAN, IRVIN SLIKE	REQUEST FOR AVAILABILITY OF COMPACT WHEEL LOADER FROM GSA SURPLUS	
10/19/2023	10:24	CAGUON	EMAIL	GSWA PROCUREMENT, RYNE SANTOS, MARISA REYES (FAR EAST EQUIPMENT), ALICIA FEJERAN, KEILANI MESA	MARKET RESEARCH LETTER	
10/19/2023	10:24	CAGUON	EMAIL	GSWA PROCUREMENT, DERRICK MUNA, (GUAM AUTO SPOT), ALICIA FEJERAN, KEILANI MESA	MARKET RESEARCH LETTER	
10/19/2023	10:24	CAGUON	EMAIL	GSWA PROCUREMENT, JIMMY CRUZ, ERIC AQUAI (HAWTHORNE), ALICIA FEJERAN, KEILANI MESA	MARKET RESEARCH LETTER	
10/19/2023	10:24	CAGUON	EMAIL	GSWA PROCUREMENT, RENE MOLINOS, PHILLIP BONNER (MORRICO EQUIPMENT), ALICIA FEJERAN, KEILANI MESA	MARKET RESEARCH LETTER	
10/19/2023	10:24	CAGUON	EMAIL	GSWA PROCUREMENT, MARK CRUZ (MIDPAC FAR EAST), ALICIA FEJERAN, KEILANI MESA	MARKET RESEARCH LETTER	
10/19/2023	10:42	CAGUON	EMAIL	MARK CRUZ (MIDPAC FAR EAST), GSWA PROCUREMENT, ALICIA FEJERAN, KEILANI MESA	RESPONSE TO MARKET RESEARCH LETTER. BROCHURES ATTACHED (SKID-STEER LOADER & ARTICULATED COMPACT WHEEL LOADER)	
10/19/2023	10:42	CAGUON	EMAIL	GSWA PROCUREMENT, KATHRINE KAKIGI, IRVIN SLIKE, ALICIA FEJERAN	REQUEST FOR JOB ORDER NUMBER & OBJECT CLASS FOR REQUISITION	
10/25/2023	11:11	CAGUON	EMAIL	GSWA PROCUREMENT, IRVIN SLIKE, ROMAN PEREZ	ADDITION TO SPEC SHEET (WARRANTY, MANUAL & USER INFO)	
10/31/2023	11:18	CAGUON	EMAIL	GSWA PROCUREMENT, MIRIAM RUPLEY (GUAM DAILY POST), ALICIA FEJERAN, KEILANI MESA	IFB ADVERTISEMENT SCHEDULED FOR 11/3/2023	
11/3/2023	08:32	CAGUON	EMAIL	GSWA PROCUREMENT, FAR EAST EQUIPMENT CO., MARISA REYES, (FAR EAST EQUIPMENT CO.), ALICIA FEJERAN, KEILANI MESA	INVITATION FOR BID NOTICE	
11/3/2023	08:32	CAGUON	EMAIL	GSWA PROCUREMENT, JIMMY CRUZ, JAN GUERRERO (HAWTHORNE), ALICIA FEJERAN, KEILANI MESA	INVITATION FOR BID NOTICE	
11/3/2023	08:32	CAGUON	EMAIL	GSWA PROCUREMENT, MARK CRUZ, CHRIS CAMACHO (MIDPAC FAR EAST), ALICIA FEJERAN, KEILANI MESA	INVITATION FOR BID NOTICE	

11/3/2023	08:32	CAGUON	EMAIL	GSWA PROCUREMENT, RENE MOLINOS, PAUL EUSTAQUIO (MORRICO EQUIPMENT), ALICIA FEJERAN, KEILANI MESA	INVITATION FOR BID NOTICE
11/3/2023	08:36	CAGUON	EMAIL	GSWA PROCUREMENT, DERRICK MUNA, (GUAM AUTO SPOT), ALICIA FEJERAN, KEILANI MESA	INVITATION FOR BID NOTICE
11/3/2023	15:00	CAGUON	PICK UP	PAUL EUSTAQUIO (MORRICO EQUIPMENT)	REQUEST FOR PROCUREMENT PACKET
11/3/2023	15:28	CAGUON	EMAIL	FAR EAST EQUIPMENT, GSWA PROCUREMENT	REQUEST FOR PROCUREMENT PACKET
11/3/2023	17:09	CAGUON	EMAIL	USA CONTRACTORS, INC., GSWA PROCUREMENT	REQUEST FOR PROCUREMENT PACKET
11/6/2023	07:25	CAGUON	EMAIL	HAWTHORNE PACIFIC CORP., GSWA PROCUREMENT	REQUEST FOR PROCUREMENT PACKET
11/9/2023	10:51	CAGUON	EMAIL	RYNE SANTOS (FAR EAST), JOHN LIMTIACO (FAR EAST), CAMARYN AGUON (GSWA)	WRITTEN QUESTIONS
11/13/2023	12:02	CAGUON	EMAIL	HAWTHORNE PACIFIC CORP., GSWA PROCUREMENT, ALICIA FEJERAN, KEILANI MESA, IRVIN SLIKE	SUBMISSION OF QUESTIONS & CONCERNS RECEIVED FROM FAR EAST EQUIPMENT ON 11/9/2023
11/13/2023	12:02	CAGUON	EMAIL	FAR EAST EQUIPMENT, GSWA PROCUREMENT, ALICIA FEJERAN, KEILANI MESA, IRVIN SLIKE	SUBMISSION OF QUESTIONS & CONCERNS RECEIVED FROM FAR EAST EQUIPMENT ON 11/9/2023
11/13/2023	12:02	CAGUON	EMAIL	MORRICO EQUIPMENT, GSWA PROCUREMENT, ALICIA FEJERAN, KEILANI MESA, IRVIN SLIKE	SUBMISSION OF QUESTIONS & CONCERNS RECEIVED FROM FAR EAST EQUIPMENT ON 11/9/2023
11/13/2023	12:02	CAGUON	EMAIL	USA CONTRACTORS CORP., GSWA PROCUREMENT, ALICIA FEJERAN, KEILANI MESA, IRVIN SLIKE	SUBMISSION OF QUESTIONS & CONCERNS RECEIVED FROM FAR EAST EQUIPMENT ON 11/9/2023
11/13/2023	13:28	CAGUON	EMAIL	FAR EAST EQUIPMENT, GSWA PROCUREMENT, ALICIA FEJERAN, KEILANI MESA, IRVIN SLIKE	ADDITIONAL WRITTEN QUESTIONS
11/13/2023	13:48	CAGUON	EMAIL	FAR EAST EQUIPMENT, GSWA PROCUREMENT, ALICIA FEJERAN, KEILANI MESA, IRVIN SLIKE	ACKNOWLEDGEMENT RECEIPT OF ADDITIONAL WRITTEN QUESTIONS
11/14/2023	13:01	CAGUON	EMAIL	GSWA PROCUREMENT, HAWTHORNE PACIFIC CORP., ALICIA FEJERAN, KEILANI MESA	AMENDMENT NO. 1
11/14/2023	13:01	CAGUON	EMAIL	GSWA PROCUREMENT, USA CONTRACTORS CORP., ALICIA FEJERAN, KEILAN MESA	AMENDMENT NO. 1
11/14/2023	13:01	CAGUON	EMAIL	GSWA PROCUREMENT, FAR EAST EQUIPMENT, ALICIA FEJERAN, KEILANI MESA	AMENDMENT NO. 1
11/14/2023	13:01	CAGUON	EMAIL	GSWA PROCUREMENT, MORRICO EQUIPMENT, ALICIA FEJERAN, KEILANI MESA	AMENDMENT NO. 1
11/14/2023	14:07	CAGUON	EMAIL	GSWA PROCUREMENT, USA CONTRACTORS CORP., ALICIA FEJERAN, KEILAN MESA	SUBMISSION OF QUESTIONS & CONCERNS RECEIVED FROM FAR EAST EQUIPMENT ON 11/13/2023
11/14/2023	14:07	CAGUON	EMAIL	GSWA PROCUREMENT, FAR EAST EQUIPMENT, ALICIA FEJERAN, KEILANI MESA	SUBMISSION OF QUESTIONS & CONCERNS RECEIVED FROM FAR EAST EQUIPMENT ON 11/13/2023
11/14/2023	14:07	CAGUON	EMAIL	GSWA PROCUREMENT, MORRICO EQUIPMENT, ALICIA FEJERAN, KEILANI MESA	SUBMISSION OF QUESTIONS & CONCERNS RECEIVED FROM FAR EAST EQUIPMENT ON 11/13/2023

11/14/2023	14:07	CAGUON	EMAIL	GSWA PROCUREMENT, HAWTHORNE PACIFIC CORP., ALICIA FEJERAN, KEILANI MESA	SUBMISSION OF QUESTIONS & CONCERNS RECEIVED FROM FAR EAST EQUIPMENT ON 11/13/2023
11/14/2023	16:38	CAGUON	EMAIL	RYNE SANTOS (FAR EAST EQUIPMENT), GSWA PROCUREMENT	ACKNOWLEDGEMENT OF AMENDMENT NO. 1
11/14/2023	16:40	CAGUON	EMAIL	RYNE SANTOS (FAR EAST EQUIPMENT), GSWA PROCUREMENT, ALICIA FEJERAN, KEILANI MESA	ACKNOWLEDGEMENT OF QUESTIONS & CONCERNS RECEIVED ON 11/13/2023
11/15/2023	16:58	CAGUON	EMAIL	PAUL EUSTAQUIO (MORRICO EQUIPMENT), GSWA PROCUREMENT, ALICIA FEJERAN, KEILANI MESA	QUESTIONS RE: BID SPECIFICATIONS
11/16/2023	14:13	CAGUON	EMAIL	USA CONTRACTORS CORP., GSWA PROCUREMENT, ALICIA FEJERAN, KEILANI MESA, IRVIN SLIKE	ACKNOWLEDGEMENT OF QUESTIONS & CONCERNS RECEIVED ON 11/13/2023
11/16/2023	14:14	CAGUON	EMAIL	USA CONTRACTORS CORP., GSWA PROCUREMENT, ALICIA FEJERAN, KEILANI MESA, IRVIN SLIKE	ACKNOWLEDGEMENT OF AMENDMENT NO. 1
11/17/2023	12:46	CAGUON	EMAIL	FAR EAST EQUIPMENT, GSWA PROCUREMENT, ALICIA FEJERAN, IRVIN SLIKE	TINK CLAW BUCKET RECOMMENDATION
11/20/2023	10:13	CAGUON	EMAIL	GSWA PROCUREMENT, ROMAN PEREZ, DENNIS MENDIOLA, JULIE CRUZ, ALICIA FEJERAN	COMMENTS REGARDING SPECS
11/20/2023	17:09	CAGUON	EMAIL	GSWA PROCUREMENT, FAR EAST EQUIPMENT, ALICIA FEJERAN, KEILANI MESA, IRVIN SLIKE	SUBMISSION OF QUESTIONS & CONCERNS & AMENDMENT NO. 2
11/20/2023	17:09	CAGUON	EMAIL	GSWA PROCUREMENT, USA CONTRACTORS CORP., ALICIA FEJERAN, KEILANI MESA, IRVIN SLIKE	SUBMISSION OF QUESTIONS & CONCERNS & AMENDMENT NO. 2
11/20/2023	17:09	CAGUON	EMAIL	GSWA PROCUREMENT, MORRICO EQUIPMENT, ALICIA FEJERAN, KEILANI MESA, IRVIN SLIKE	SUBMISSION OF QUESTIONS & CONCERNS & AMENDMENT NO. 2
11/20/2023	17:09	CAGUON	EMAIL	GSWA PROCUREMENT, HAWTHORNE PACIFIC CORP., ALICIA FEJERAN, KEILANI MESA, IRVIN SLIKE	SUBMISSION OF QUESTIONS & CONCERNS & AMENDMENT NO. 2
11/20/2023	17:09	CAGUON	EMAIL	GSWA PROCUREMENT, MIDPAC FAR EAST, ALICIA FEJERAN, KEILANI MESA, IRVIN SLIKE	SUBMISSION OF QUESTIONS & CONCERNS & AMENDMENT NO. 2
11/21/2023	15:53	CAGUON	EMAIL	USA CONTRACTORS CORP., GSWA PROCUREMENT, ALICIA FEJERAN, KEILANI MESA, IRVIN SLIKE	ACKNOWLEDGEMENT OF QUESTIONS & CONCERNS & AMENDMENT NO. 2
11/22/2023	12:31	CAGUON	EMAIL	MORRICO EQUIPMENT, GSWA PROCUREMENT	REQUEST FOR PROCUREMENT PACKET (AGAIN)
11/22/2023	13:13	CAGUON	FAX	FAR EAST EQUIPMENT, GSWA PROCUREMENT	ACKNOWLEDGEMENT OF AMENDMENT NO. 2 & QUESTIONS & CONCERNS ON 11/15/2023
11/24/2023	16:46	CAGUON	EMAIL	FAR EAST EQUIPMENT, GSWA PROCUREMENT	REQUEST TO EXTEND BID OPENING FROM 11/28/2023 TO 12/5/2023
11/27/2023	14:27	CAGUON	EMAIL	GSWA PROCUREMENT, MORRICO EQUIPMENT, ALICIA FEJERAN, KEILANI MESA, IRVIN SLIKE	AMENDMENT NO. 3
11/27/2023	14:27	CAGUON	EMAIL	GSWA PROCUREMENT, FAR EAST EQUIPMENT, ALICIA FEJERAN, KEILANI MESA, IRVIN SLIKE	AMENDMENT NO. 3
11/27/2023	14:27	CAGUON	EMAIL	GSWA PROCUREMENT, HAWTHORNE PACIFIC CORP., ALICIA FEJERAN, KEILANI MESA, IRVIN SLIKE	AMENDMENT NO. 3

11/27/2023	14:27	CAGUON	EMAIL	GSWA PROCUREMENT, USA CONTRACTORS CORP., ALICIA FEJERAN, KEILANI MESA, IRVIN SLIKE	AMENDMENT NO. 3
11/27/2023	14:27	CAGUON	EMAIL	GSWA PROCUREMENT, MIDPAC FAR EAST, ALICIA FEJERAN, KEILANI MESA, IRVIN SLIKE	AMENDMENT NO. 3
11/27/2023	14:46	CAGUON	EMAIL	MORRICO EQUIPMENT, GSWA PROCUREMENT, ALICIA FEJERAN, KEILANI MESA, IRVIN SLIKE	ACKNOWLEDGEMENT OF AMENDMENT NO. 3
11/30/2023	14:31	CAGUON	EMAIL	USA CONTRACTORS CORP., GSWA PROCUREMENT, ALICIA FEJERAN, KEILANI MESA, IRVIN SLIKE	ACKNOWLEDGEMENT OF AMENDMENT NO. 3
12/13/2023	10:31	CAGUON	EMAIL	GSWA PROCUREMENT, FAR EAST EQUIPMENT, ALICIA FEJERAN, KEILANI MESA, IRVIN SLIKE	NOTICE OF INTENT OF POSSIBLE AWARD
12/13/2023	10:31	CAGUON	EMAIL	GSWA PROCUREMENT, MORRICO EQUIPMENT, ALICIA FEJERAN, KEILANI MESA, IRVIN SLIKE	BID STATUS
12/13/2023	16:39	CAGUON	EMAIL	MORRICO EQUIPMENT, GSWA PROCUREMENT, ALICIA FEJERAN, KEILANI MESA, IRVIN SLIKE	REQUEST FOR NON-CONFORMANCE SPECIFICATIONS
12/15/2023	15:29	CAGUON	EMAIL	MORRICO EQUIPMENT, GSWA PROCUREMENT, ALICIA FEJERAN, KEILANI MESA, IRVIN SLIKE	FOLLOW UP ON WHICH SPECS WERE NON-CONFORMANCE
12/15/2023	16:54	CAGUON	EMAIL	GSWA PROCUREMENT, MORRICO EQUIPMENT, ALICIA FEJERAN, KEILANI MESA, IRVIN SLIKE	REVISED BID STATUS TO INCLUDE SPECIFICATIONS NOT IN COMPLIANCE
12/19/2023	17:48	CAGUON	EMAIL	GSWA PROCUREMENT, PAUL EUSTAQUIO, ALICIA FEJERAN, KEILANI MESA, IRVIN SLIKE, ROSS MORRISON, JESSE MUNOZ, JOEL LESH	SUBMISSION OF REVISED BID STATUS & FOIA REQUEST FOR FAR EAST'S BID PACKET
12/20/2023	10:19	CAGUON	EMAIL	KEILANI MESA, IRVIN SLIKE, ALICIA FEJERAN, GSWA PROCUREMENT	SUBMISSION OF MORRICO EQUIPMENT'S FOIA REQUEST
12/21/2023	10:24	CAGUON	EMAIL	GSWA PROCUREMENT, PAUL EUSTAQUIO, ALICIA FEJERAN, KEILANI MESA, IRVIN SLIKE, ROSS MORRISON, JESSE MUNOZ, JOEL LESH	RESPONSE TO MORRICO EQUIPMENT'S FOIA REQUEST
12/27/2023	14:28	CAGUON	DROP-OFF	ROBERTS FOWLER VISOSKY, LLP, GSWA PROCUREMENT	DELIVERY OF PROCUREMENT PROTEST BY MORRICO EQUIPMENT
12/27/2023	15:22	CAGUON	EMAIL	GSWA PROCUREMENT, IRVIN SLIKE, ALICIA FEJERAN	SUBMISSION OF PROCUREMENT PROTEST & STAY OF PROCUREMENT FOR REVIEW
12/27/2023	16:12	CAGUON	EMAIL	GSWA PROCUREMENT, HAWTHORNE PACIFIC, ALICIA FEJERAN, KEILANI MESA, IRVIN SLIKE	NOTICE RE: STAY OF PROCUREMENT
12/27/2023	16:12	CAGUON	EMAIL	GSWA PROCUREMENT, FAR EAST EQUIPMENT, ALICIA FEJERAN, KEILANI MESA, IRVIN SLIKE	NOTICE RE: STAY OF PROCUREMENT
12/27/2023	16:12	CAGUON	EMAIL	GSWA PROCUREMENT, USA CONTRACTORS CORP., ALICIA FEJERAN, KEILANI MESA, IRVIN SLIKE	NOTICE RE: STAY OF PROCUREMENT
12/27/2023	16:12	CAGUON	EMAIL	GSWA PROCUREMENT, MORRICO EQUIPMENT, ALICIA FEJERAN, KEILANI MESA, IRVIN SLIKE	NOTICE RE: STAY OF PROCUREMENT
12/27/2023	16:14	CAGUON	EMAIL	GSWA PROCUREMENT, MIDPAC FAR EAST, ALICIA FEJERAN, KEILANI MESA, IRVIN SLIKE	NOTICE RE: STAY OF PROCUREMENT

12/28/2023	18:49	CAGUON	EMAIL	FAR EAST EQUIPMENT, GSWA PROCUREMENT, ALICIA FEJERAN, KEILANI MESA, IRVIN SLIKE	INFORMATION REGARDING STEPS MORRICO SHOULD HAVE TAKEN IN ORDER TO HAVE DEVIATIONS APPROVED BY GSWA
01/25/2024	14:26	A FEJERAN	EMAIL	IRVIN SLIKE, ALICIA FEJERAN, ANDREW GAYLE (BOARD CHAIRMAN)	RESPONSE TO FOLLOW UP FROM GM SLIKE
04/05/2024	10:45	CAGUON	DELIVERY	GSWA PROCUREMENT, ATTY. KEVIN FOWLER	GSWA'S RESPONSE TO MORRICO EQUIPMENT'S PROTEST
04/08/2024	15:25	CAGUON	EMAIL	GSWA PROCUREMENT, USA CONTRACTORS, ALICIA FEJERAN, KEILANI MESA, ROMAN PEREZ, DENNIS MENDIOLA	NOTICE RE: LIFT OF STAY
04/08/2024	15:26	CAGUON	EMAIL	GSWA PROCUREMENT, GUAM AUTOSPOT, ALICIA FEJERAN, KEILANI MESA, ROMAN PEREZ, DENNIS MENDIOLA	NOTICE RE: LIFT OF STAY
04/08/2024	15:26	CAGUON	EMAIL	GSWA PROCUREMENT, MORRICO EQUIPMENT, ALICIA FEJERAN, KEILANI MESA, ROMAN PEREZ, DENNIS MENDIOLA	NOTICE RE: LIFT OF STAY
04/08/2024	15:25	CAGUON	EMAIL	GSWA PROCUREMENT, MIDPAC FAR EAST, ALICIA FEJERAN, KEILANI MESA, ROMAN PEREZ, DENNIS MENDIOLA	NOTICE RE: LIFT OF STAY
04/08/2024	15:26	CAGUON	EMAIL	GSWA PROCUREMENT, HAWTHORNE PACIFIC, ALICIA FEJERAN, KEILANI MESA, ROMAN PEREZ, DENNIS MENDIOLA	NOTICE RE: LIFT OF STAY
04/08/2024	15:26	CAGUON	EMAIL	GSWA PROCUREMENT, FAR EAST EQUIPMENT, ALICIA FEJERAN, KEILANI MESA, ROMAN PEREZ, DENNIS MENDIOLA	NOTICE RE: LIFT OF STAY
04/08/2024	17:04	CAGUON	EMAIL	GSWA PROCUREMENT, FAR EAST EQUIPMENT, ALICIA FEJERAN, KEILANI MESA, ROMAN PEREZ, DENNIS MENDIOLA	REQUEST FOR SCHEDULE TO SIGN CONTRACT
04/08/2024	19:43	CAGUON	EMAIL	GSWA PROCUREMENT, FAR EAST EQUIPMENT, ALICIA FEJERAN, KEILANI MESA	RESPONSE FROM FAR EAST RE CONTRACT SIGNING
04/09/2024	09:22	CAGUON	FAX	FAR EAST EQUIPMENT	ACKNOWLEDGEMENT OF NOTICE RE: LIFT OF STAY
04/09/2024	09:28	CAGUON	EMAIL	FAR EAST EQUIPMENT, GSWA PROCUREMENT	ACKNOWLEDGEMENT OF NOTICE RE: LIFT OF STAY
04/11/2024	18:27	CAGUON	EMAIL	FAR EAST EQUIPMENT, GSWA PROCUREMENT, ALICIA FEJERAN, KEILANI MESA	CONTRACT SIGNING SCHEDULING
04/16/2024	09:10	CAGUON	EMAIL	GSWA PROCUREMENT, FAR EAST EQUIPMENT	REQUEST FOR ESTIMATED TIMEFRAME FOR DELIVERY

FILE**Small Wheel loader and attachments**

5 messages

Irvin Slike <irvin.slike@gswa.guam.gov>

28 August 2023 at 10:53

To: GSWA Procurement <procurement@gswa.guam.gov>

Cc: Roman Perez <roman.perez@gswa.guam.gov>, Dennis Mendiola <dennis.mendiola@gswa.guam.gov>

Cam,

When you get a chance could you format this into a Guam spec sheet?

Roman and Dennis look these over and add any features you may want

 **Small Wheel Loader and Attachments.docx**
15K**GSWA Procurement** <procurement@gswa.guam.gov>

28 August 2023 at 10:56

To: Irvin Slike <irvin.slike@gswa.guam.gov>

Cc: Roman Perez <roman.perez@gswa.guam.gov>, Dennis Mendiola <dennis.mendiola@gswa.guam.gov>

Will work on this today!

[Quoted text hidden]

Roman Perez <roman.perez@gswa.guam.gov>

28 August 2023 at 11:54

To: GSWA Procurement <procurement@gswa.guam.gov>

Cc: Irvin Slike <irvin.slike@gswa.guam.gov>, Dennis Mendiola <dennis.mendiola@gswa.guam.gov>

Looks good, thanks!

[Quoted text hidden]

FILE**Irvin Slike** <irvin.slike@gswa.guam.gov>

11 October 2023 at 11:21

To: GSWA Procurement <procurement@gswa.guam.gov>, Alicia Fejeran <alicia.fejeran@gswa.guam.gov>, Kathrine Kakigi

<kkakigi.gswa@gmail.com>

Could we put this bid out?

[Quoted text hidden]

 **Small Wheel Loader and Attachments.docx**
15K**Alicia Fejeran** <alicia.fejeran@gswa.guam.gov>

11 October 2023 at 11:46

To: Irvin Slike <irvin.slike@gswa.guam.gov>

Cc: GSWA Procurement <procurement@gswa.guam.gov>, Kathrine Kakigi <kkakigi.gswa@gmail.com>

Yes, Cam will get a price estimate so we can identify our budget for this.

Thanks,
Alicia

[Quoted text hidden]

Outgoing Bin

4 messages

GWSA Procurement <procurement@gswa.guam.gov>

16 October 2023 at 17:10

To: Roman Perez <roman.perez@gswa.guam.gov>, Dennis Mendiola <dennis.mendiola@gswa.guam.gov>

Cc: Alicia Fejeran <alicia.fejeran@gswa.guam.gov>, Keilani Mesa <keilani.mesa@gswa.guam.gov>, Julie Cruz <julie.cruz@gswa.guam.gov>

Håfa Adai!

Please be advised that there are still documents in your Outgoing Bin that require review & signatures. The documents are as follows:

- Compact Wheel Loader Spec Sheet
- Memorandum for Hydraulic Oil

There is also a Purchase Order for Island Equipment for the gas tanks. PO has already been sent to the vendor & added to the drive. Please see attached for reference.

Thank you!

*Si Yu'os Ma'åse,***Camaryn Aguon****Buyer I****GUAM SOLID WASTE AUTHORITY**

546 N. Marine Corps Dr., Tamuning, Guam 96913

T: (671) 646-3111 | F: (671) 649-3777

W: www.gswa.guam.gov **P246R00030 Original.pdf**
3958K**Roman Perez** <roman.perez@gswa.guam.gov>

16 October 2023 at 17:18

To: GWSA Procurement <procurement@gswa.guam.gov>

Cc: Dennis Mendiola <dennis.mendiola@gswa.guam.gov>, Alicia Fejeran <alicia.fejeran@gswa.guam.gov>, Keilani Mesa <keilani.mesa@gswa.guam.gov>, Julie Cruz <julie.cruz@gswa.guam.gov>

I will take care of it tomorrow

[Quoted text hidden]

GWSA Procurement <procurement@gswa.guam.gov>

18 October 2023 at 12:30

To: Roman Perez <roman.perez@gswa.guam.gov>

Cc: Dennis Mendiola <dennis.mendiola@gswa.guam.gov>, Alicia Fejeran <alicia.fejeran@gswa.guam.gov>, Keilani Mesa <keilani.mesa@gswa.guam.gov>, Julie Cruz <julie.cruz@gswa.guam.gov>

Kindly following up on the signed justification / memorandum for the Hydraulic Oil. Please advise.

Thank you!

Best Regards,
Camaryn

[Quoted text hidden]

Request for Availability of Compact Wheel Loader

4 messages

GWSA Procurement <procurement@gswa.guam.gov>

18 October 2023 at 12:14

To: Raymond.Bamba@gsadoa.guam.gov

Cc: Alicia Fejeran <alicia.fejeran@gswa.guam.gov>, Irvin Slike <irvin.slike@gswa.guam.gov>

Håfa Adai!

The Guam Solid Waste Authority is looking to purchase **one (1) Compact Wheel Loader**. Pursuant to 5 GCA 3130 (d), I am submitting this inquiry to you to see if this item / equipment is available in inventory at the Surplus Division of GSA.

Thank you for your assistance!

*Si Yu'os Ma'åse,***Camaryn Aguon****Buyer I****GUAM SOLID WASTE AUTHORITY**

546 N. Marine Corps Dr., Tamuning, Guam 96913

T: (671) 646-3111 | F: (671) 649-3777

W: www.gswa.guam.gov**Raymond Bamba** <Raymond.Bamba@gsadoa.guam.gov>

18 October 2023 at 12:19

To: GWSA Procurement <procurement@gswa.guam.gov>

Hi Camaryn,

Your request for a Compact Wheel Loader is unavailable .

Regards,

Ray Bamba

[Quoted text hidden]

GWSA Procurement <procurement@gswa.guam.gov>

18 October 2023 at 12:27

To: Raymond Bamba <Raymond.Bamba@gsadoa.guam.gov>

Cc: Alicia Fejeran <alicia.fejeran@gswa.guam.gov>, Irvin Slike <irvin.slike@gswa.guam.gov>

Thank you for your reply!

Market Research to Acquire Compact Wheel Loader & Attachments

1 message

GSWA Procurement <procurement@gswa.guam.gov>

19 October 2023 at 10:24

To: Ryne Santos <rsantos@fareastequipment.com>, Marisa Reyes <mreyes@fareastequipment.com>

Cc: Alicia Fejeran <alicia.fejeran@gswa.guam.gov>, Keilani Mesa <keilani.mesa@gswa.guam.gov>

Håfa Adai!

The Guam Solid Waste Authority is conducting market research of equipment dealerships to provide a **Compact Wheel Loader & attachments to include coupling mechanisms, forks, bucket with bold on edge, claw bucket & pick-up broom** for the Guam Solid Waste Authority. Please respond via return email if your company can provide the required equipment and estimated time of availability.

Should you have any question or concerns, please contact GSWA Chief of Administration, Alicia Fejeran, at (671) 646-3111 or via email at procurement@gswa.guam.gov.



Si Yu'os Ma'åse,

Camaryn Aguon

Buyer I

GUAM SOLID WASTE AUTHORITY

546 N. Marine Corps Dr., Tamuning, Guam 96913

T: (671) 646-3111 | F: (671) 649-3777

W: www.gswa.guam.gov

Market Research to Acquire Compact Wheel Loader & Attachments

1 message

GWSA Procurement <procurement@gswa.guam.gov>

19 October 2023 at 10:24

To: derrick@guamautospot.com

Cc: Alicia Fejeran <alicia.fejeran@gswa.guam.gov>, Keilani Mesa <keilani.mesa@gswa.guam.gov>

Håfa Adai!

The Guam Solid Waste Authority is conducting market research of equipment dealerships to provide a **Compact Wheel Loader & attachments to include coupling mechanisms, forks, bucket with bold on edge, claw bucket & pick-up broom** for the Guam Solid Waste Authority. Please respond via return email if your company can provide the required equipment and estimated time of availability.

Should you have any question or concerns, please contact GSWA Chief of Administration, Alicia Fejeran, at (671) 646-3111 or via email at procurement@gswa.guam.gov.



Si Yu'os Ma'åse,

Camaryn Aguon

Buyer I

GUAM SOLID WASTE AUTHORITY

546 N. Marine Corps Dr., Tamuning, Guam 96913

T: (671) 646-3111 | F: (671) 649-3777

W: www.gswa.guam.gov

Market Research to Acquire Compact Wheel Loader & Attachments

1 message

GWSA Procurement <procurement@gswa.guam.gov>

19 October 2023 at 10:24

To: Jimmy Cruz <JPCRUZ@hawthornecat.com>, Eric Aquai <eaquai@hawthornecat.com>

Cc: Alicia Fejeran <alicia.fejeran@gswa.guam.gov>, Keilani Mesa <keilani.mesa@gswa.guam.gov>

Håfa Adai!

The Guam Solid Waste Authority is conducting market research of equipment dealerships to provide a **Compact Wheel Loader & attachments to include coupling mechanisms, forks, bucket with bold on edge, claw bucket & pick-up broom** for the Guam Solid Waste Authority. Please respond via return email if your company can provide the required equipment and estimated time of availability.

Should you have any question or concerns, please contact GSWA Chief of Administration, Alicia Fejeran, at (671) 646-3111 or via email at procurement@gswa.guam.gov.



Si Yu'os Ma'åse,

Camaryn Aguon

Buyer I

GUAM SOLID WASTE AUTHORITY

546 N. Marine Corps Dr., Tamuning, Guam 96913

T: (671) 646-3111 | F: (671) 649-3777

W: www.gswa.guam.gov

Market Research to Acquire Compact Wheel Loader & Attachments

1 message

GSWA Procurement <procurement@gswa.guam.gov>

19 October 2023 at 10:25

To: Rene Molinos <Rene@morricoequipment.com>, Phillip Bonner <Phillip.Bonner@morricoequipment.com>

Cc: Alicia Fejeran <alicia.fejeran@gswa.guam.gov>, Keilani Mesa <keilani.mesa@gswa.guam.gov>

Håfa Adai!

The Guam Solid Waste Authority is conducting market research of equipment dealerships to provide a **Compact Wheel Loader & attachments to include coupling mechanisms, forks, bucket with bold on edge, claw bucket & pick-up broom** for the Guam Solid Waste Authority. Please respond via return email if your company can provide the required equipment and estimated time of availability.

Should you have any question or concerns, please contact GSWA Chief of Administration, Alicia Fejeran, at (671) 646-3111 or via email at procurement@gswa.guam.gov.



Si Yu'os Ma'åse,

Camaryn Aguon

Buyer I

GUAM SOLID WASTE AUTHORITY

546 N. Marine Corps Dr., Tamuning, Guam 96913

T: (671) 646-3111 | F: (671) 649-3777

W: www.gswa.guam.gov

Market Research to Acquire Compact Wheel Loader & Attachments

10 messages

GWSA Procurement <procurement@gsua.guam.gov>

19 October 2023 at 10:24

To: "Mark S. Cruz" <mcruz@midpacfareast.com>

Cc: Alicia Fejeran <alicia.fejeran@gsua.guam.gov>, Keilani Mesa <keilani.mesa@gsua.guam.gov>

Håfa Adai!

The Guam Solid Waste Authority is conducting market research of equipment dealerships to provide a **Compact Wheel Loader & attachments to include coupling mechanisms, forks, bucket with bold on edge, claw bucket & pick-up broom** for the Guam Solid Waste Authority. Please respond via return email if your company can provide the required equipment and estimated time of availability.

Should you have any question or concerns, please contact GSWA Chief of Administration, Alicia Fejeran, at (671) 646-3111 or via email at procurement@gsua.guam.gov.

*Si Yu'os Ma'åse,***Camaryn Aguon****Buyer I****GUAM SOLID WASTE AUTHORITY**

546 N. Marine Corps Dr., Tamuning, Guam 96913

T: (671) 646-3111 | F: (671) 649-3777

W: www.gswa.guam.gov

Mark S. Cruz <mcruz@midpacfareast.com>

19 October 2023 at 10:42

To: Alicia Fejeran <alicia.fejeran@gsua.guam.gov>

Cc: Keilani Mesa <keilani.mesa@gsua.guam.gov>, GSWA Procurement <procurement@gsua.guam.gov>, Chris Camacho <ccamacho@midpacfareast.com>, Joshua Reyes <jreyes@midpacfareast.com>

Hafa Adai Alicia,

Do you have a Make/Model we can use as a reference?

It sounds like you may be looking for a Skid-Steer Loader. Please see attached brochure.

Best Regards & Stay Safe,

Mark S. Cruz

Sales Manager

Mid Pac Far East, LLC

M: (671) 486-2789

[Quoted text hidden]

 **SSL-Brochure-EN (2022).pdf**
17358K

Mark S. Cruz <mcruz@midpacfareast.com>

19 October 2023 at 10:43

To: Alicia Fejeran <alicia.fejeran@gsua.guam.gov>



<ccamacno@midpacfareast.com>, Joshua Reyes <jreyes@midpacfareast.com>

Or maybe the attached Articulated Compact Wheel Loader.

Best Regards & Stay Safe,

Mark S. Cruz

Sales Manager

Mid Pac Far East, LLC

M: (671) 486-2789

[Quoted text hidden]

 **CWL-brochure-EN (2022).pdf**
15560K

GSWA Procurement <procurement@gswa.guam.gov>

19 October 2023 at 10:48

To: "Mark S. Cruz" <mcruz@midpacfareast.com>

Cc: Alicia Fejeran <alicia.fejeran@gswa.guam.gov>, Keilani Mesa <keilani.mesa@gswa.guam.gov>, Chris Camacho <ccamacno@midpacfareast.com>, Joshua Reyes <jreyes@midpacfareast.com>

Hi, Mark!

Thank you for the information. We will look into this & get back to you.

Best Regards,

Camaryn

[Quoted text hidden]

GSWA Procurement <procurement@gswa.guam.gov>

19 October 2023 at 10:54

To: "Mark S. Cruz" <mcruz@midpacfareast.com>

Cc: Alicia Fejeran <alicia.fejeran@gswa.guam.gov>, Keilani Mesa <keilani.mesa@gswa.guam.gov>, Chris Camacho <ccamacno@midpacfareast.com>, Joshua Reyes <jreyes@midpacfareast.com>

Hi, Mark.

The Compact Wheel Loader is what we are looking for. If we were to purchase this, can I get a timeframe for when it will be here?

Best Regards,

Camaryn

[Quoted text hidden]

Mark S. Cruz <mcruz@midpacfareast.com>

19 October 2023 at 10:57

To: GSWA Procurement <procurement@gswa.guam.gov>

Cc: Alicia Fejeran <alicia.fejeran@gswa.guam.gov>, Keilani Mesa <keilani.mesa@gswa.guam.gov>, Chris Camacho <ccamacno@midpacfareast.com>, Joshua Reyes <jreyes@midpacfareast.com>

Which size?

Best Regards & Stay Safe,

Mark S. Cruz

Sales Manager

Mid Pac Far East, LLC

M: (671) 486-2789

[Quoted text hidden]

To: Roman Perez <roman.perez@gswa.guam.gov>, Irvin Slike <irvin.slike@gswa.guam.gov>

Hi, Mr. Slike / Roman!

MidPac would like to know what size of the Compact Wheel Loader we are looking at purchasing so he can get an ETA. Please advise.

Thank you!

Best Regards,
Camaryn

[Quoted text hidden]

 **CWL-brochure-EN (2022).pdf**
15560K

Irvin Slike <irvin.slike@gswa.guam.gov>

19 October 2023 at 16:53

To: GSWA Procurement <procurement@gswa.guam.gov>, Roman Perez <roman.perez@gswa.guam.gov>

It is similar to John Deere 244/P or equal horse power and weight

[Quoted text hidden]

GSWA Procurement <procurement@gswa.guam.gov>

19 October 2023 at 17:02

To: "Mark S. Cruz" <mcruz@midpacfareast.com>

Cc: Alicia Fejeran <alicia.fejeran@gswa.guam.gov>, Keilani Mesa <keilani.mesa@gswa.guam.gov>, Chris Camacho <ccamacho@midpacfareast.com>, Joshua Reyes <jreyes@midpacfareast.com>

Hi, Mark.

Sorry for the delay. Per our GM, the size we are looking for is similar to John Deere 244/P or equal horsepower & weight. The specs are as follows:

- Net Power: 52 kW (71 hp) at 2,400 rpm
- Operating Weight: 5560 kg (12,258 lb.)
- Bucket Capacity: 0.8–1.1 m³ (1.0–1.4 cu. yd.)

Best Regards,
Camaryn

[Quoted text hidden]

GSWA Procurement <procurement@gswa.guam.gov>

25 October 2023 at 11:07

To: "Mark S. Cruz" <mcruz@midpacfareast.com>

Cc: Alicia Fejeran <alicia.fejeran@gswa.guam.gov>, Keilani Mesa <keilani.mesa@gswa.guam.gov>, Chris Camacho <ccamacho@midpacfareast.com>, Joshua Reyes <jreyes@midpacfareast.com>

Hi, Mark. Following up on the ETA of the Compact Wheel Loader. Please advise.

Thank you!

Best Regards,
Camaryn

[Quoted text hidden]



FILE

Small Wheel loader and attachments

GSWA Procurement <procurement@gswa.guam.gov>

19 October 2023 at 10:42

To: Kathrine Kakigi <kathrine.kakigi@gswa.guam.gov>

Cc: Irvin Slike <irvin.slike@gswa.guam.gov>, Alicia Fejeran <alicia.fejeran@gswa.guam.gov>

Hi, Kathy!

For the Compact Wheel Loader, which account will we be using for the funding, so I can prepare the Requisition.

Thank you!

Camaryn

[Quoted text hidden]

○

○



Compact Wheel Loader Specs

5 messages

GSWA Procurement <procurement@gswa.guam.gov>

25 October 2023 at 11:11

To: Irvin Slike <irvin.slike@gswa.guam.gov>, Roman Perez <roman.perez@gswa.guam.gov>

Håfa Adai, Mr. Slike / Roman!

For the Spec Sheet for the loader, Alicia noticed that there is no portion about warranty, user manual, parts manual, engine manual, operator training & service training. Did you want to include these? If so, please advise at your earliest convenience what exactly to put, so I can add it in.

Thank you!

Si Yu'os Ma'åse,



Camaryn Aguon

Buyer I

GUAM SOLID WASTE AUTHORITY

546 N. Marine Corps Dr., Tamuning, Guam 96913

T: (671) 646-3111 | F: (671) 649-3777

W: www.gswa.guam.gov

Roman Perez <roman.perez@gswa.guam.gov>

25 October 2023 at 11:13

To: GSWA Procurement <procurement@gswa.guam.gov>

Cc: Irvin Slike <irvin.slike@gswa.guam.gov>

Yes please, thank you.

[Quoted text hidden]

GSWA Procurement <procurement@gswa.guam.gov>

25 October 2023 at 11:22

To: Roman Perez <roman.perez@gswa.guam.gov>

Cc: Irvin Slike <irvin.slike@gswa.guam.gov>

Please let me know if the following is good to include on the spec sheet:

Miscellaneous Items:

One (1) operator's manual hardcopy

One (1) operator's manual on CD

One (1) complete illustrated parts book

One (1) shop repair manual

One (1) warranty manual

Manufacturer's training of GSWA crew (8 hours) & contracted mechanics (20 hours)

Online manual for parts, service & repair

Delivered with a full tank of fuel

Irvin Slike <irvin.slike@gswa.guam.gov>
To: GSWA Procurement <procurement@gswa.guam.gov>

25 October 2023 at 11:51

Yes this is good.....just make it standard on all equipment purchases

[Quoted text hidden]

GSWA Procurement <procurement@gswa.guam.gov>
To: Irvin Slike <irvin.slike@gswa.guam.gov>

25 October 2023 at 11:53

Will do, thank you!

[Quoted text hidden]

IFB Advertisement - GSWA-004-24: Compact Wheel Loader w/ Attachments

8 messages

GSWA Procurement <procurement@gswa.guam.gov>

31 October 2023 at 11:18

To: Miriam Rupley <miriam@postguam.com>

Cc: Alicia Fejeran <alicia.fejeran@gswa.guam.gov>, Keilani Mesa <keilani.mesa@gswa.guam.gov>

Håfa Adai, Miriam!

Please see attached IFB notice for publishing on Friday, November 3, 2023. PO #P246R00018.

Thank you!

*Si Yu'os Ma'åse,***Camaryn Aguon****Buyer I****GUAM SOLID WASTE AUTHORITY**

546 N. Marine Corps Dr., Tamuning, Guam 96913

T: (671) 646-3111 | F: (671) 649-3777

W: www.gswa.guam.gov

 **GSWA-004-24 Newspaper Advertisement.pdf**
128K**Miriam Rupley** <miriam@postguam.com>

31 October 2023 at 15:16

To: GSWA Procurement <procurement@gswa.guam.gov>

Cc: Alicia Fejeran <alicia.fejeran@gswa.guam.gov>, Keilani Mesa <keilani.mesa@gswa.guam.gov>

Good afternoon Camryn,

Please see the attached proof for your review. Kindly advise if any change are needed or if approved for publication.

Also attached is the invoice, kindly send a signed copy. Thank you!

Miriam Rupley | *Account Executive***THE GUAM DAILY POST**

388 S. Marine Corps Drive, Suite 301, Tamuning, Guam 96913

Office: 671.649.1924 Mobile: 671.727.6062 Email: miriam@postguam.com

Website: www.postguam.com

<u>PUBLICATION DAY</u>	<u>RESERVATION DEADLINE</u>	<u>NEED TO BUILD DEADLINE</u>	<u>CAMERA-READY DEADLINE</u>
MONDAY	WEDNESDAY, 12PM	WEDNESDAY, 12PM	THURSDAY, 12PM
TUESDAY	THURSDAY, 12PM	THURSDAY, 12PM	FRIDAY, 12PM
WEDNESDAY	FRIDAY, 12PM	FRIDAY, 12PM	MONDAY, 12PM
THURSDAY	MONDAY, 12PM	MONDAY, 12PM	TUESDAY, 12PM
FRIDAY	TUESDAY, 12PM	TUESDAY, 12PM	WEDNESDAY, 12PM
SATURDAY	WEDNESDAY, 12PM	WEDNESDAY, 12PM	THURSDAY, 12PM
SUNDAY	WEDNESDAY, 12PM	WEDNESDAY, 12PM	THURSDAY, 12PM



Follow us on

THINK BEFORE YOU PRINT: Please consider the environment before printing this email.

This electronic message transmission contains information from The Guam Daily Post that may be proprietary, confidential and/or privileged. The information is intended only for the use of the individual(s) or entity named above. If you are not the intended recipient, be aware that any disclosure, copying or distribution or use of the contents of this information is prohibited. If you have received this electronic transmission in error, please notify the sender immediately by replying to the address listed in the "From:" field.

From: GSWA Procurement <procurement@gswa.guam.gov>
Sent: Tuesday, October 31, 2023 11:18 AM
To: Miriam Rupley <miriam@postguam.com>
Cc: Alicia Fejeran <alicia.fejeran@gswa.guam.gov>; Keilani Mesa <keilani.mesa@gswa.guam.gov>
Subject: IFB Advertisement - GSWA-004-24: Compact Wheel Loader w/ Attachments

[Quoted text hidden]

"Disclaimer: The content of this message is confidential and intended only for the use of the individual or entity to which it is addressed. If you have received it by mistake, please inform us by an email reply and then delete the message. It is prohibited to copy, forward, or in any way reveal the contents of this message to anyone. The integrity and security of this email cannot be guaranteed over the Internet. Therefore, the sender will not be held liable for any damage caused by the message."

2 attachments

- 91061-GSWA-IFB-2x4.pdf**
739K
- A91061 GSWA IFB-004-24.pdf**
109K

GSWA Procurement <procurement@gswa.guam.gov> 31 October 2023 at 15:26
To: Miriam Rupley <miriam@postguam.com>
Cc: Alicia Fejeran <alicia.fejeran@gswa.guam.gov>, Keilani Mesa <keilani.mesa@gswa.guam.gov>

Hi, Miriam!

The time for the Bid Opening is supposed to say 1:00pm.
 [Quoted text hidden]

Miriam Rupley <miriam@postguam.com> 1 November 2023 at 11:22
To: GSWA Procurement <procurement@gswa.guam.gov>

Good morning,
Please see the attached revised proof for your review. Thank you!

Miriam Rupley | Account Executive
THE GUAM DAILY POST

388 S. Marine Corps Drive, Suite 301, Tamuning, Guam 96913
Office: 671.649.1924 Mobile: 671.727.6062 Email: miriam@postguam.com
Website: www.postguam.com

TIMELINE AND AD PRODUCTION GUIDELINES

<u>PUBLICATION DAY</u>	<u>RESERVATION DEADLINE</u>	<u>NEED TO BUILD DEADLINE</u>	<u>CAMERA-READY DEADLINE</u>
MONDAY	WEDNESDAY, 12PM	WEDNESDAY, 12PM	THURSDAY, 12PM
TUESDAY	THURSDAY, 12PM	THURSDAY, 12PM	FRIDAY, 12PM
WEDNESDAY	FRIDAY, 12PM	FRIDAY, 12PM	MONDAY, 12PM
THURSDAY	MONDAY, 12PM	MONDAY, 12PM	TUESDAY, 12PM
FRIDAY	TUESDAY, 12PM	TUESDAY, 12PM	WEDNESDAY, 12PM
SATURDAY	WEDNESDAY, 12PM	WEDNESDAY, 12PM	THURSDAY, 12PM
SUNDAY	WEDNESDAY, 12PM	WEDNESDAY, 12PM	THURSDAY, 12PM



Follow us on

THINK BEFORE YOU PRINT: Please consider the environment before printing this email.

This electronic message transmission contains information from The Guam Daily Post that may be proprietary, confidential and/or privileged. The information is intended only for the use of the individual(s) or entity named above. If you are not the intended recipient, be aware that any disclosure, copying or distribution or use of the contents of this information is prohibited. If you have received this electronic transmission in error, please notify the sender immediately by replying to the address listed in the "From:" field.

From: GSWA Procurement <procurement@gswa.guam.gov>
Sent: Tuesday, October 31, 2023 3:26 PM
To: Miriam Rupley <miriam@postguam.com>
Cc: Alicia Fejeran <alicia.fejeran@gswa.guam.gov>; Keilani Mesa <keilani.mesa@gswa.guam.gov>
Subject: Re: IFB Advertisement - GSWA-004-24: Compact Wheel Loader w/ Attachments

[Quoted text hidden]

91061-GSWA-IFB-2x4 (1).pdf
739K

Alicia Fejeran <alicia.fejeran@gswa.guam.gov>
To: Miriam Rupley <miriam@postguam.com>
Cc: GSWA Procurement <procurement@gswa.guam.gov>, Keilani Mesa <keilani.mesa@gswa.guam.gov>

1 November 2023 at 11:33

Hafa adai Miriam,

Thanks,
Alicia

[Quoted text hidden]

2 attachments

 **GSWA IFB PROOF_SIGNED.pdf**
978K

 **INVOICE_SIGNED.pdf**
714K

Alicia Fejeran <alicia.fejeran@gswa.guam.gov> 1 November 2023 at 11:40
To: Miriam Rupley <miriam@postguam.com>
Cc: GSWA Procurement <procurement@gswa.guam.gov>, Keilani Mesa <keilani.mesa@gswa.guam.gov>

Hi Miriam,

I was trying to access your E-Edition to obtain a copy of our ad in today's publication. However, I'm having trouble accessing it. It's stating that the page is no longer available. Please advise how I can view today's E-Edition.

Thanks,
Alicia

[Quoted text hidden]

Miriam Rupley <miriam@postguam.com> 1 November 2023 at 13:38
To: Alicia Fejeran <alicia.fejeran@gswa.guam.gov>
Cc: GSWA Procurement <procurement@gswa.guam.gov>, Keilani Mesa <keilani.mesa@gswa.guam.gov>, Sedrick Serisola <sedrick@postguam.com>

Hi Alicia,

Where you given a username and password for the e-edition by my office or are you trying to access on the postguam.com website?

I've copied my webmaster in this email for assistance. Thank you!

Hi Sedrick,

Just a heads up for Ms. Alcia's reply regarding e-edition access. Thank you!

Miriam Rupley | *Account Executive*

THE GUAM DAILY POST

388 S. Marine Corps Drive, Suite 301, Tamuning, Guam 96913

Office: 671.649.1924 Mobile: 671.727.6062 Email: miriam@postguam.com

Website: www.postguam.com

<u>PUBLICATION DAY</u>	<u>RESERVATION DEADLINE</u>	<u>NEED TO BUILD DEADLINE</u>	<u>CAMERA-READY DEADLINE</u>
MONDAY	WEDNESDAY, 12PM	WEDNESDAY, 12PM	THURSDAY, 12PM
TUESDAY	THURSDAY, 12PM	THURSDAY, 12PM	FRIDAY, 12PM
WEDNESDAY	FRIDAY, 12PM	FRIDAY, 12PM	MONDAY, 12PM
THURSDAY	MONDAY, 12PM	MONDAY, 12PM	TUESDAY, 12PM
FRIDAY	TUESDAY, 12PM	TUESDAY, 12PM	WEDNESDAY, 12PM
SATURDAY	WEDNESDAY, 12PM	WEDNESDAY, 12PM	THURSDAY, 12PM
SUNDAY	WEDNESDAY, 12PM	WEDNESDAY, 12PM	THURSDAY, 12PM



Follow us on

THINK BEFORE YOU PRINT. Please consider the environment before printing this email.

This electronic message transmission contains information from The Guam Daily Post that may be proprietary, confidential and/or privileged. The information is intended only for the use of the individual(s) or entity named above. If you are not the intended recipient, be aware that any disclosure, copying or distribution or use of the contents of this information is prohibited. If you have received this electronic transmission in error, please notify the sender immediately by replying to the address listed in the "From:" field.

From: Alicia Fejeran <alicia.fejeran@gswa.guam.gov>
Sent: Wednesday, November 1, 2023 11:40 AM
To: Miriam Rupley <miriam@postguam.com>
Cc: GSWA Procurement <procurement@gswa.guam.gov>; Keilani Mesa <keilani.mesa@gswa.guam.gov>
 [Quoted text hidden]

[Quoted text hidden]

Alicia Fejeran <alicia.fejeran@gswa.guam.gov> 1 November 2023 at 13:55
To: Miriam Rupley <miriam@postguam.com>
Cc: GSWA Procurement <procurement@gswa.guam.gov>, Keilani Mesa <keilani.mesa@gswa.guam.gov>, Sedrick Serisola <sedrick@postguam.com>

Hi Miriam and Sedrick,

I was trying to access it on the postguam website. I appreciate any help you can provide.

Thanks,
 Alicia

[Quoted text hidden]

IFB Notice: GSWA-004-24: Compact Wheel Loader

messages

GWSA Procurement <procurement@gswa.guam.gov>

To: John Limtiaco <jlimtiaco@fareastequipment.com>, Marisa Reyes <mreyes@fareastequipment.com>

Cc: Alicia Fejeran <alicia.fejeran@gswa.guam.gov>, Keilani Mesa <keilani.mesa@gswa.guam.gov>

3 November 2023 at 08:32

INVITATION FOR BID (IFB)

Bid No: GSWA-004-24
For: Compact Wheel Loader
Bid Opening Date: Monday, November 20, 2023
Time: 1:00 p.m. ChST
Location: Guam Solid Waste Authority, 2nd Floor

Bid packages may be picked up at Guam Solid Waste Authority, 546 N. Marine Corps Dr. in Upper Tumon, 2nd Floor, beginning Friday, November 3, 2023 until Monday, November 20, 2023, or visit the GSWA website <http://www.guamsolidwasteauthority.com> to obtain an electronic copy of the IFB.

For more information, please contact Alicia Fejeran, Chief of Administration, at 671-646-3111.

*Si Yu'os Ma'åse,***Camaryn Aguon****Buyer I****GUAM SOLID WASTE AUTHORITY**

546 N. Marine Corps Dr., Tamuning, Guam 96913

T: (671) 646-3111 | F: (671) 649-3777

W: www.gswa.guam.gov

John Limtiaco <jlimtiaco@fareastequipment.com>

To: GSWA Procurement <procurement@gswa.guam.gov>

Cc: Marisa Reyes <mreyes@fareastequipment.com>, Alicia Fejeran <alicia.fejeran@gswa.guam.gov>, Keilani Mesa <keilani.mesa@gswa.guam.gov>, Ryna Santos <rsantos@fareastequipme

Dear Procurement Team,

When you click to register for packet it goes to 24 Cubic yard refuse truck? Please fix and advise when available for download.

Thank you.



24 CUBIC YARD REFUSE TRUCKS

(Scroll down to request packet)

Procurement Number : GSWA-004-23

Procurement Type : IFB

Title : 24 CUBIC YARD REFUSE TRUCKS

Division/Department : Procurement

Posted on : September 08, 2023 08:00 AM CHST (Guam time)

Amendments, Notices, and other files : 2 **Amendment No. 1**

Type: Amendment

Posted on: September 10, 2023 08:00 AM CHST (Guam time)

> [Click to view](#)

Responses to Questions submitted by Septen

Type: Questions & Answers

Posted on: September 20, 2023 08:00 AM CHST (Guam time)

> [Click to view](#)

Issue Date (Open Date/Time) : September 08, 2023 08:00 AM CHST (Guam time)

Submission (Close Date/Time) : September 25, 2023 10:00 AM CHST (Guam time)

Packet Fee : N/A

Short Description:

N/A

Long Description:

N/A

The packet is no longer available.

sincerely,
John A. Limtiaco
President
Corporate Office: 671-473-4374
DID: 671-473-7378
M: 671-888-6270



[Quoted text hidden]

Alicia Fejeran <alicia.fejeran@gswa.guam.gov>
To: John Limtiaco <jlimtiaco@fareastequipment.com>
Cc: GSWA Procurement <procurement@gswa.guam.gov>, Marisa Reyes <mreyes@fareastequipment.com>, Keilani Mesa <keilani.mesa@gswa.guam.gov>, Ryne Santos <rsantos@fareastequipment.com>

3 November 2023 at 14:51

Hi John,

Thanks,
Alicia

[Quoted text hidden]

John Limtiaco <jlimtiaco@fareastequipment.com>

3 November 2023 at 15:29

To: Alicia Fejeran <alicia.fejeran@gswa.guam.gov>

Cc: GSWA Procurement <procurement@gswa.guam.gov>, Marisa Reyes <mreyes@fareastequipment.com>, Keilani Mesa <keilani.mesa@gswa.guam.gov>, Ryne Santos <rsantos@fareastequipment.com>

Thank, You.
John A. Limtiaco
President
Corporate Office: 671-473-4374
DID: 671-473-7378
M. 671-888-6270



[Quoted text hidden]



GWSA Procurement <procurement@gswa.guam.gov>

FILE**IFB Notice: GSWA-004-24: Compact Wheel Loader**

1 message

GWSA Procurement <procurement@gswa.guam.gov>

3 November 2023 at 08:32

To: Jimmy Cruz <JPCRUZ@hawthornecat.com>, Jan Lee Arceo-Guerrero <jguerrero@hawthornecat.com>

Cc: Alicia Fejeran <alicia.fejeran@gswa.guam.gov>, Keilani Mesa <keilani.mesa@gswa.guam.gov>

INVITATION FOR BID (IFB)

Bid No: GSWA-004-24
For: Compact Wheel Loader
Bid Opening Date: Monday, November 20, 2023
Time: 1:00 p.m. ChST
Location: Guam Solid Waste Authority, 2nd Floor

Bid packages may be picked up at Guam Solid Waste Authority, 546 N. Marine Corps Dr. in Upper Tumon, 2nd Floor, beginning Friday, November 3, 2023 until Monday, November 20, 2023, or visit the GSWA website <http://www.guamsolidwasteauthority.com> to obtain an electronic copy of the IFB.

For more information, please contact Alicia Fejeran, Chief of Administration, at 671-646-3111.

*Si Yu'os Ma'åse,***Camaryn Aguon****Buyer I****GUAM SOLID WASTE AUTHORITY**

546 N. Marine Corps Dr., Tamuning, Guam 96913

T: (671) 646-3111 | F: (671) 649-3777

W: www.gswa.guam.gov

**FILE**

GWSA Procurement <procurement@gswa.guam.gov>

IFB Notice: GSWA-004-24: Compact Wheel Loader

1 message

GWSA Procurement <procurement@gswa.guam.gov>

3 November 2023 at 08:32

To: "Mark S. Cruz" <mcruz@midpacfareast.com>, Chris Camacho <ccamacho@midpacfareast.com>

Cc: Alicia Fejeran <alicia.fejeran@gswa.guam.gov>, Keilani Mesa <keilani.mesa@gswa.guam.gov>

INVITATION FOR BID (IFB)

Bid No: GSWA-004-24
For: Compact Wheel Loader
Bid Opening Date: Monday, November 20, 2023
Time: 1:00 p.m. ChST
Location: Guam Solid Waste Authority, 2nd Floor

Bid packages may be picked up at Guam Solid Waste Authority, 546 N. Marine Corps Dr. in Upper Tumon, 2nd Floor, beginning Friday, November 3, 2023 until Monday, November 20, 2023, or visit the GSWA website <http://www.guamsolidwasteauthority.com> to obtain an electronic copy of the IFB.

For more information, please contact Alicia Fejeran, Chief of Administration, at 671-646-3111.

*Si Yu'os Ma'åse,***Camaryn Aguon****Buyer I****GUAM SOLID WASTE AUTHORITY**

546 N. Marine Corps Dr., Tamuning, Guam 96913

T: (671) 646-3111 | F: (671) 649-3777

W: www.gswa.guam.gov

**FILE**

GWSA Procurement <procurement@gswa.guam.gov>

IFB Notice: GSWA-004-24: Compact Wheel Loader

1 message

GWSA Procurement <procurement@gswa.guam.gov>

3 November 2023 at 08:32

To: Rene Molinos <Rene@morricoequipment.com>, Paul Eustaquio <paul@morricoequipment.com>

Bcc: Alicia Fejeran <alicia.fejeran@gswa.guam.gov>, Keilani Mesa <keilani.mesa@gswa.guam.gov>

INVITATION FOR BID (IFB)

Bid No: GSWA-004-24
For: Compact Wheel Loader
Bid Opening Date: Monday, November 20, 2023
Time: 1:00 p.m. ChST
Location: Guam Solid Waste Authority, 2nd Floor

Bid packages may be picked up at Guam Solid Waste Authority, 546 N. Marine Corps Dr. in Upper Tumon, 2nd Floor, beginning Friday, November 3, 2023 until Monday, November 20, 2023, or visit the GSWA website <http://www.guamsolidwasteauthority.com> to obtain an electronic copy of the IFB.

For more information, please contact Alicia Fejeran, Chief of Administration, at 671-646-3111.

*Si Yu'os Ma'åse,***Camaryn Aguon****Buyer I****GUAM SOLID WASTE AUTHORITY**

546 N. Marine Corps Dr., Tamuning, Guam 96913

T: (671) 646-3111 | F: (671) 649-3777

W: www.gswa.guam.gov

FILE



GSWA Procurement <procurement@gswa.guam.gov>

IFB Notice: GSWA-004-24: Compact Wheel Loader

1 message

GSWA Procurement <procurement@gswa.guam.gov>

3 November 2023 at 08:36

To: derrick@guamautospot.com

Cc: Alicia Fejeran <alicia.fejeran@gswa.guam.gov>, Keilani Mesa <keilani.mesa@gswa.guam.gov>

INVITATION FOR BID (IFB)

Bid No:	GSWA-004-24
For:	Compact Wheel Loader
Bid Opening Date:	Monday, November 20, 2023
Time:	1:00 p.m. ChST
Location:	Guam Solid Waste Authority, 2 nd Floor

Bid packages may be picked up at Guam Solid Waste Authority, 546 N. Marine Corps Dr. in Upper Tumon, 2nd Floor, beginning Friday, November 3, 2023 until Monday, November 20, 2023, or visit the GSWA website <http://www.guamsolidwasteauthority.com> to obtain an electronic copy of the IFB.

For more information, please contact Alicia Fejeran, Chief of Administration, at 671-646-3111.



Si Yu'os Ma'åse,

Camaryn Aguon

Buyer I

GUAM SOLID WASTE AUTHORITY

546 N. Marine Corps Dr., Tamuning, Guam 96913

T: (671) 646-3111 | F: (671) 649-3777

W: www.gswa.guam.gov

BIDDER'S RECORD TRY LOG

Bid Package Pick Up

IFB NO.:

GSWA-004-24

PROJECT NAME:

COMPACT WHEEL LOADER W/ ATTACHMENTS

Date / Time of Bid Opening:

NOVEMBER 20, 2023 @ 1:00PM



Business Name	Point of Contact (Primary)	Contact No. (Primary)	Point of Contact (Alternate)	Contact No. (Alternate)	Fax No.:	Email Address:	Business Mailing Address	Date / Time Vendor Picked Up Package
1 Merrico Equipment	Paul Eustage	(671) 483-1180	Jesse Muroz	(671) 482-4750	(671) 644-1847	Paul@merricoequipment.com	197 Ypoo Pond Tannung, Guam 96913	11/2/23 3:00 PM
2 Far Edge Equipment Co.	John Limtiaco	(671) 896-0270		(671) 473-4374		limtiaco@faredgesequipment.com	P.O. BOX 10838 Tannung, Guam 96913	11/3/2023 3:28 PM
3 USA Contractors	Eddie Onopey	(671) 632-3044			(671) 632-9000	sales@usacontractorscorp.com	138 Kayen Charado St.	11/3/2023 5:09 PM
4 Hawthorne Pacific	JIMMY CRUZ	(671) 488-2821				jpaul@hawthornepac.com	196 E. Harmon Industrial Park Rd. Tannung, Guam 96913	11/06/2023 7:25 am
5								
6								
7								
8								
9								
10								
11								
12								

FILE

**FILE****Procurement Packet: Far East Equipment Company LLC GSWA-004-24**

1 message

GSWA Procurement <procurement@gswa.guam.gov>
To: submissions@guamwebz.com

3 November 2023 at 15:28

A Procurement Packet has been requested from the website. Below is the copy of the email sent to the user who made the request.

Hafa Adai John Limtiaco,

You requested a Procurement Packet from the website.

Click the link(s) listed below to Download and View the Procurement Packet file(s) for:
> Download Link: [IFB NO. GSWA-004-24](#)

Procurement Number: GSWA-004-24
Title/Description: COMPACT WHEEL LOADER

REQUESTED BY:**First Name:** John**Last Name:** Limtiaco**Company:** Far East Equipment Company LLC**Address:** 17-3311 Corsair Rd.**Email:** jlimtiaco@fareastequipment.com**Telephone:** 6718886270**Fax Number:**

<https://guamsolidwasteauthority.com>



GSWA Procurement <procurement@gswa.guam.gov> **FILE**

Procurement Packet: USA CONTRACTORS, INC. GSWA-004-24

1 message

GSWA Procurement <procurement@gswa.guam.gov>
To: submissions@guamwebz.com

3 November 2023 at 17:09

A Procurement Packet has been requested from the website. Below is the copy of the email sent to the user who made the request.

Hafa Adai Eddie Onopey,

You requested a Procurement Packet from the website.

Click the link(s) listed below to Download and View the Procurement Packet file(s) for:
> Download Link: [IFB NO. GSWA-004-24](#)

Procurement Number: GSWA-004-24
Title/Description: COMPACT WHEEL LOADER

REQUESTED BY:

First Name: Eddie

Last Name: Onopey

Company: USA CONTRACTORS, INC.

Address: 138 Kayen Chando Street

Email: sales@usacontractorscorp.com

Telephone: 6716323044

Fax Number: 6716329000



<https://guamsolidwasteauthority.com>



FILE
GSWA Procurement <procurement@gswa.guam.gov>

Procurement Packet: Hawthorne Pacific Corp GSWA-004-24

1 message

GSWA Procurement <procurement@gswa.guam.gov>
To: submissions@guamwebz.com

6 November 2023 at 07:25

A Procurement Packet has been requested from the website. Below is the copy of the email sent to the user who made the request.

Hafa Adai Jimmy Cruz,

You requested a Procurement Packet from the website.

Click the link(s) listed below to Download and View the Procurement Packet file(s) for:
> [Download Link: IFB NO. GSWA-004-24](#)

Procurement Number: GSWA-004-24
Title/Description: COMPACT WHEEL LOADER

REQUESTED BY:

First Name: Jimmy

Last Name: Cruz

Company: Hawthorne Pacific Corp

Address: 196 East Harmon Industrial Park Road Tamuning Guam 96913

Email: jpcruz@hawthornecat.com

Telephone: 671-488-2821

Fax Number:



<https://guamsolidwasteauthority.com>



GSWA Procurement <procurement@gsi.guam.gov>

FILE**GSWA-004-24 Compact Wheel Loader Questions**

2 messages

Ryne Santos <rsantos@fareastequipment.com>
To: GSWA Procurement <procurement@gsi.guam.gov>
Cc: John Limtiaco <jlimtiaco@fareastequipment.com>

9 November 2023 at 10:51

Hafa Adai GSWA Procurement:

Please see below questions for the bid in subject.

1. In the specs under **Powertrain** the spec reads "Max rise and fall single wheel: 15 inch maximum, 14 inch minimum."
- Will 10 inches be acceptable?

2. In the specs under **Cooling** the spec reads "Hydraulically driven, proportionally controlled fan".
- Will direct driven be acceptable?

3. In the specs under **Hydraulics** the spec reads "Main pump (loader and steering): 18 GPM standard, 29 GPM with high flow option".
- Will a max rated flow 21.13 GPM @ 1,000 PSI be acceptable?
- Can you clarify why there is a request for high flow option when the requested attachments do not require high flow hydraulics?

4. In the specs under **Electrical** the spec reads "Battery capacity: 925 CCA"
- Will 830 CCA be acceptable?

--Best regards,
Ryne-Paul Santos
Sales
Far East Equipment Co. LLC
P.O. Box 10838
Tamuning, Guam 96931



GSWA Procurement <procurement@gsi.guam.gov>
To: Alicia Fejeran <alicia.fejeran@gsi.guam.gov>, Irvin Slike <irvin.slike@gsi.guam.gov>

9 November 2023 at 11:40

FYI.

[Quoted text hidden]

**GSWA-004-24: Compact Wheel Loader**

1 message

GSWA Procurement <procurement@gswa.guam.gov>

13 November 2023 at 12:02

To: Jimmy Cruz <JPCRUZ@hawthornecat.com>

Cc: Alicia Fejeran <alicia.fejeran@gswa.guam.gov>, Keilani Mesa <keilani.mesa@gswa.guam.gov>, Irvin Slike <irvin.slike@gswa.guam.gov>

Háfa Adai!

Please see attached Questions & Concerns in regards to the above-mentioned IFB for your reference. Please sign the acknowledgement on the bottom of the page & submit back at your earliest convenience.

Thank you!

*Si Yu'os Ma'åse,***Camaryn Aguon****Buyer I****GUAM SOLID WASTE AUTHORITY**

546 N. Marine Corps Dr., Tamuning, Guam 96913

T: (671) 646-3111 | F: (671) 649-3777

W: www.gswa.guam.gov **GSWA-004-24 Q&C - 11.13.2023.pdf**
44K

**FILE**

GWSA Procurement <procurement@gswa.guam.gov>

GWSA-004-24: Compact Wheel Loader

1 message

GWSA Procurement <procurement@gswa.guam.gov>

13 November 2023 at 12:02

To: John Limtiaco <jlimtiaco@fareastequipment.com>, Ryne Santos <rsantos@fareastequipment.com>

Cc: Alicia Fejeran <alicia.fejeran@gswa.guam.gov>, Keilani Mesa <keilani.mesa@gswa.guam.gov>, Irvin Slike <irvin.slike@gswa.guam.gov>

Håfa Adai!

Please see attached Questions & Concerns in regards to the above-mentioned IFB for your reference. Please sign the acknowledgement on the bottom of the page & submit back at your earliest convenience.

Thank you!

*Si Yu'os Ma'åse,***Camaryn Aguon****Buyer I****GUAM SOLID WASTE AUTHORITY**

546 N. Marine Corps Dr., Tamuning, Guam 96913

T: (671) 646-3111 | F: (671) 649-3777

W: www.gswa.guam.gov

 **GWSA-004-24 Q&C - 11.13.2023.pdf**

44K



FILE
GWSA Procurement <procurement@gswa.guam.gov>

GWSA-004-24: Compact Wheel Loader

1 message

GWSA Procurement <procurement@gswa.guam.gov>

13 November 2023 at 12:02

To: Paul Eustaquio <paul@morricequipment.com>

Cc: Alicia Fejeran <alicia.fejeran@gswa.guam.gov>, Keilani Mesa <keilani.mesa@gswa.guam.gov>, Irvin Slike <irvin.slike@gswa.guam.gov>

Håfa Adai!

Please see attached Questions & Concerns in regards to the above-mentioned IFB for your reference. Please sign the acknowledgement on the bottom of the page & submit back at your earliest convenience.

Thank you!



Si Yu'os Ma'åse,

Camaryn Aguon

Buyer I

GUAM SOLID WASTE AUTHORITY

546 N. Marine Corps Dr., Tamuning, Guam 96913

T: (671) 646-3111 | F: (671) 649-3777

W: www.gswa.guam.gov

GWSA-004-24 Q&C - 11.13.2023.pdf
44K



GWSA Procurement <procurement@gswa-guam.gov>

FILE**GWSA-004-24: Compact Wheel Loader**

1 message

GWSA Procurement <procurement@gswa.guam.gov>

13 November 2023 at 12:02

To: sales@usacontractorscorp.com

Cc: Alicia Fejeran <alicia.fejeran@gswa.guam.gov>, Keilani Mesa <keilani.mesa@gswa.guam.gov>, Irvin Slike <irvin.slike@gswa.guam.gov>

Håfa Adai!

Please see attached Questions & Concerns in regards to the above-mentioned IFB for your reference. Please sign the acknowledgement on the bottom of the page & submit back at your earliest convenience.

Thank you!

*Si Yu'os Ma'åse,***Camaryn Aguon****Buyer I****GUAM SOLID WASTE AUTHORITY**

546 N. Marine Corps Dr., Tamuning, Guam 96913

T: (671) 646-3111 | F: (671) 649-3777

W: www.gswa.guam.gov

GWSA-004-24 Q&C - 11.13.2023.pdf

44K

**GSWA-004-24: Compact Wheel Loader**

Ryne Santos <rsantos@fareastequipment.com>

13 November 2023 at 13:28

To: GSWA Procurement <procurement@gsa.guam.gov>

Cc: John Limtiaco <jlimtiaco@fareastequipment.com>, Alicia Fejeran <alicia.fejeran@gsa.guam.gov>, Keilani Mesa <keilani.mesa@gsa.guam.gov>, Irvin Slike <irvin.slike@gsa.guam.gov>

Hafa Adai GSWA Procurement:

Please see attached signed and acknowledged Q&A Response. Please see additional inquiries below.

1. In regards to the high-flow hydraulics requirement for the broom attachment, John Deere's broom attachment does "NOT" require high-flow. Will high-flow still be required?
2. What Make and Model machine was used to form the specs of this bid?

Best regards,
Ryne

[Quoted text hidden]

--

Ryne-Paul Santos
Sales
Far East Equipment Co. LLC
P.O. Box 10838
Tamuning, Guam 96931 **GSWA-004-24 Q&A Response 11.9.23 SIGNED.pdf**
328K



GSWA Procurement <procurement@gswa.guam.gov> **FILE**

GSWA-004-24: Compact Wheel Loader

GSWA Procurement <procurement@gswa.guam.gov>

13 November 2023 at 13:47

To: Ryne Santos <rsantos@fareastequipment.com>

Cc: John Limtiaco <jlimtiaco@fareastequipment.com>, Alicia Fejeran <alicia.fejeran@gswa.guam.gov>, Keilani Mesa <keilani.mesa@gswa.guam.gov>, Irvin Slike <irvin.slike@gswa.guam.gov>

Hi, Ryne.

Confirming receipt of additional questions. We will get back to you as soon as we can.

Best Regards,
Camaryn

[Quoted text hidden]

FILE

GWSA Procurement <procurement@gsa.guam.gov>

GWSA-004-24: Compact Wheel Loader w/ Attachments

1 message

GWSA Procurement <procurement@gsa.guam.gov>

14 November 2023 at 13:01

To: Jimmy Cruz <JPCRUZ@hawthornecat.com>

Cc: Alicia Fejeran <alicia.fejeran@gsa.guam.gov>, Keilani Mesa <keilani.mesa@gsa.guam.gov>

Håfa Adai!

Please see attached Amendment No. 1 for your reference. Please sign the acknowledgement portion on the second page & submit back at your earliest convenience.

Thank you!

*Si Yu'os.Ma'åse,***Camaryn Aguon****Buyer I****GUAM SOLID WASTE AUTHORITY**

546 N. Marine Corps Dr., Tamuning, Guam 96913

T: 671-646-3111 | F: 671-649-3777

W: www.gswa.guam.gov**GWSA-004-24 Amendment No. 1.pdf**

45K



GSWA Procurement <procurement@gswa.guam.gov> **FILE**

GSWA-004-24: Compact Wheel Loader w/ Attachments

1 message

GSWA Procurement <procurement@gswa.guam.gov>

14 November 2023 at 13:01

To: USA Contractors Corporation <sales@usacontractorscorp.com>

Cc: Alicia Fejeran <alicia.fejeran@gswa.guam.gov>, Keilani Mesa <keilani.mesa@gswa.guam.gov>

Håfa Adai!

Please see attached Amendment No. 1 for your reference. Please sign the acknowledgement portion on the second page & submit back at your earliest convenience.

Thank you!



Si Yu'os Ma'åse,

Camaryn Aguon

Buyer I

GUAM SOLID WASTE AUTHORITY

546 N. Marine Corps Dr., Tamuning, Guam 96913

T: 671-646-3111 | F: 671-649-3777

W: www.gswa.guam.gov

GSWA-004-24 Amendment No. 1.pdf

45K

FILE

GWSA Procurement <procurement@gswa.guam.gov>

GWSA-004-24: Compact Wheel Loader w/ Attachments

1 message

GWSA Procurement <procurement@gswa.guam.gov>

14 November 2023 at 13:01

To: John Limtiaco <jlimtiaco@fareastequipment.com>

Cc: Alicia Fejeran <alicia.fejeran@gswa.guam.gov>, Keilani Mesa <keilani.mesa@gswa.guam.gov>

Håfa Adai!

Please see attached Amendment No. 1 for your reference. Please sign the acknowledgement portion on the second page & submit back at your earliest convenience.

Thank you!

*Si Yu'os Ma'àse,***Camaryn Aguon****Buyer I****GUAM SOLID WASTE AUTHORITY**

546 N. Marine Corps Dr., Tamuning, Guam 96913

T: 671-646-3111 | F: 671-649-3777

W: www.gswa.guam.gov **GWSA-004-24 Amendment No. 1.pdf**

45K

FILE



GSWA Procurement <procurement@gswa.guam.gov>

GSWA-004-24: Compact Wheel Loader w/ Attachments

1 message

GSWA Procurement <procurement@gswa.guam.gov>

14 November 2023 at 13:01

To: Paul Eustaquio <paul@morricoequipment.com>

Cc: Alicia Fejeran <alicia.fejeran@gswa.guam.gov>, Keilani Mesa <keilani.mesa@gswa.guam.gov>

Håfa Adai!

Please see attached Amendment No. 1 for your reference. Please sign the acknowledgement portion on the second page & submit back at your earliest convenience.

Thank you!



Si Yu'os Ma'åse,
Camaryn Aguon
Buyer I
GUAM SOLID WASTE AUTHORITY
546 N. Marine Corps Dr., Tamuning, Guam 96913
T: 671-646-3111 | F: 671-649-3777
W: www.gswa.guam.gov

GSWA-004-24 Amendment No. 1.pdf

45K

**FILE****GWSA-004-24: Compact Wheel Loader w/ Attachments**

1 message

GWSA Procurement <procurement@gsa.guam.gov>

14 November 2023 at 14:07

To: USA Contractors Corporation <sales@usacontractorscorp.com>

Cc: Alicia Fejeran <alicia.fejeran@gsa.guam.gov>, Keilani Mesa <keilani.mesa@gsa.guam.gov>

Háfa Adai!

Please see attached Questions & Concerns in regards to the above-mentioned IFB for your reference. Please sign the acknowledgement on the bottom of the page & submit back at your earliest convenience.

Thank you!

*Si Yu'os Ma'åse,***Camaryn Aguon****Buyer I****GUAM SOLID WASTE AUTHORITY**

546 N. Marine Corps Dr., Tamuning, Guam 96913

T: (671) 646-3111 | F: (671) 649-3777

W: www.gsa.guam.gov **GWSA-004-24 Q&C - 11.14.2023.pdf**
34K

**FILE****GWSA-004-24: Compact Wheel Loader w/ Attachments**

1 message

GWSA Procurement <procurement@gswa.guam.gov>

14 November 2023 at 14:07

To: John Limtiaco <jlimtiaco@fareastequipment.com>, Ryne Santos <rsantos@fareastequipment.com>

Cc: Alicia Fejeran <alicia.fejeran@gswa.guam.gov>, Keilani Mesa <keilani.mesa@gswa.guam.gov>

Håfa Adai!

Please see attached Questions & Concerns in regards to the above-mentioned IFB for your reference. Please sign the acknowledgement on the bottom of the page & submit back at your earliest convenience.

Thank you!

*Si Yu'os Ma'åse,***Camaryn Aguon****Buyer I****GUAM SOLID WASTE AUTHORITY**

546 N. Marine Corps Dr., Tamuning, Guam 96913

T: (671) 646-3111 | F: (671) 649-3777

W: www.gswa.guam.gov

GWSA-004-24 Q&C - 11.14.2023.pdf

34K

FILE



GWSA Procurement <procurement@gsa.guam.gov>

GWSA-004-24: Compact Wheel Loader w/ Attachments

1 message

GWSA Procurement <procurement@gsa.guam.gov>

14 November 2023 at 14:08

To: Paul Eustaquio <paul@morricequipment.com>

Cc: Alicia Fejeran <alicia.fejeran@gsa.guam.gov>, Keilani Mesa <keilani.mesa@gsa.guam.gov>

Háfa Adai!

Please see attached Questions & Concerns in regards to the above-mentioned IFB for your reference. Please sign the acknowledgement on the bottom of the page & submit back at your earliest convenience.

Thank you!

*Si Yu'os Ma'åse,***Camaryn Aguon****Buyer I****GUAM SOLID WASTE AUTHORITY**

546 N. Marine Corps Dr., Tamuning, Guam 96913

T: (671) 646-3111 | F: (671) 649-3777

W: www.gsa.guam.gov **GWSA-004-24 Q&C - 11.14.2023.pdf**
34K

GWSA Procurement <procurement@gsa.guam.gov> **FILE****GWSA-004-24: Compact Wheel Loader w/ Attachments**

1 message

GWSA Procurement <procurement@gsa.guam.gov>

14 November 2023 at 14:08

To: Jimmy Cruz <JPCRUIZ@hawthornecat.com>

Cc: Alicia Fejeran <alicia.fejeran@gsa.guam.gov>, Keilani Mesa <keilani.mesa@gsa.guam.gov>

Håfa Adai!

Please see attached Questions & Concerns in regards to the above-mentioned IFB for your reference. Please sign the acknowledgement on the bottom of the page & submit back at your earliest convenience.

Thank you!

*Si Yu'os Ma'åse,***Camaryn Aguon****Buyer I****GUAM SOLID WASTE AUTHORITY**

546 N. Marine Corps Dr., Tamuning, Guam 96913

T: (671) 646-3111 | F: (671) 649-3777

W: www.gsa.guam.gov

GWSA-004-24 Q&C - 11.14.2023.pdf

34K



GSWA Procurement <procurement@gswa.guam.gov> **FILE**

GSWA-004-24: Compact Wheel Loader w/ Attachments

4 messages

GSWA Procurement <procurement@gswa.guam.gov> 14 November 2023 at 13:01
To: John Limtiaco <jlimtiaco@fareastequipment.com>
Cc: Alicia Fejeran <alicia.fejeran@gswa.guam.gov>, Keilani Mesa <keilani.mesa@gswa.guam.gov>

Håfa Adai!

Please see attached Amendment No. 1 for your reference. Please sign the acknowledgement portion on the second page & submit back at your earliest convenience.

Thank you!



Si Yu'os Ma'åse,
Camaryn Aguon
Buyer I
GUAM SOLID WASTE AUTHORITY
546 N. Marine Corps Dr., Tamuning, Guam 96913
T: 671-646-3111 | F: 671-649-3777
W: www.gswa.guam.gov

GSWA-004-24 Amendment No. 1.pdf
45K

GSWA Procurement <procurement@gswa.guam.gov> 14 November 2023 at 14:09
To: Ryne Santos <rsantos@fareastequipment.com>

Hi, Ryne.

My apologies. Please see attached Amendment previously sent to Mr. Limtiaco.
[Quoted text hidden]

GSWA-004-24 Amendment No. 1.pdf
45K

FILE

Ryne Santos <rsantos@fareastequipment.com> 14 November 2023 at 16:38
To: GSWA Procurement <procurement@gswa.guam.gov>

Hafa Adai GSWA Procurement:

Please see attached signed and acknowledged Amendment 1.

Best regards,
Ryne
[Quoted text hidden]

--
Ryne-Paul Santos
Sales
Far East Equipment Co. LLC
P.O. Box 10838
Tamuning, Guam 96931



 **GSWA-004-24 Amendment 1 SIGNED_11142023163552.pdf**
346K

GSWA Procurement <procurement@gswa.guam.gov>
To: Ryne Santos <rsantos@fareastequipment.com>

14 November 2023 at 16:43

Received, thank you!

Camaryn
[Quoted text hidden]

FILE



GSWA Procurement <procurement@gswa.guam.gov>

GSWA-004-24: Compact Wheel Loader w/ Attachments

3 messages

GSWA Procurement <procurement@gswa.guam.gov> 14 November 2023 at 14:07
To: John Limtiaco <jlimtiaco@fareastequipment.com>, Ryne Santos <rsantos@fareastequipment.com>
Cc: Alicia Fejeran <alicia.fejeran@gswa.guam.gov>, Keilani Mesa <keilani.mesa@gswa.guam.gov>

Håfa Adai!

Please see attached Questions & Concerns in regards to the above-mentioned IFB for your reference. Please sign the acknowledgement on the bottom of the page & submit back at your earliest convenience.

Thank you!



Si Yu'os Ma'åse,

Camaryn Aguon

Buyer I

GUAM SOLID WASTE AUTHORITY

546 N. Marine Corps Dr., Tamuning, Guam 96913

T: (671) 646-3111 | F: (671) 649-3777

W: www.gswa.guam.gov

GSWA-004-24 Q&C - 11.14.2023.pdf
34K

FILE

Ryne Santos <rsantos@fareastequipment.com> 14 November 2023 at 16:40
To: GSWA Procurement <procurement@gswa.guam.gov>
Cc: John Limtiaco <jlimtiaco@fareastequipment.com>, Alicia Fejeran <alicia.fejeran@gswa.guam.gov>, Keilani Mesa <keilani.mesa@gswa.guam.gov>, Marisa Reyes <mreyes@fareastequipment.com>

Hafa Adai GSWA Procurement:

Please see attached signed and acknowledged Q&A Response.

Best regards,

Ryne

[Quoted text hidden]

--
Ryne-Paul Santos
Sales
Far East Equipment Co. LLC
P.O. Box 10838
Tamuning, Guam 96931



**FILE****GSWA-004-24: Compact Wheel Loader w/ Attachments**

Paul Eustaquio <Paul@morricequipment.com>
To: GSWA Procurement <procurement@gswa.guam.gov>
Cc: Alicia Fejeran <alicia.fejeran@gswa.guam.gov>, Keilani Mesa <keilani.mesa@gswa.guam.gov>

15 November 2023 at 16:51

Hello Camaryn,

Please see attached questions for Bid # GSWA-004-24.

Please confirm once questions have been received.

Regards,

Paul Eustaquio

Heavy Equipment Sales

Mobile: 671.483.0180



197 Ypao Road, Tamuning Guam 96913
671.649.1946
morricequipment.com



This message and any attachments are intended only for the use of the addressee and may contain information that is privileged and confidential. If the reader of the message is not the intended recipient or an authorized representative of the intended recipient, you are hereby notified that any dissemination of this communication is strictly prohibited. If you have received this communication in error, please notify us immediately by e-mail and delete the message and any attachments from your system.

From: GSWA Procurement <procurement@gswa.guam.gov>
Sent: Tuesday, November 14, 2023 2:08 PM
To: Paul Eustaquio <paul@morricequipment.com>
Cc: Alicia Fejeran <alicia.fejeran@gswa.guam.gov>; Keilani Mesa <keilani.mesa@gswa.guam.gov>
Subject: GSWA-004-24: Compact Wheel Loader w/ Attachments

[Quoted text hidden]

GSWA-004-24-COMPACT WHEEL LOADER WITH ATTACHMENTS Morrigo Questions.pdf
141K



GWSA Procurement <procurement@gswa.guam.gov>

GWSA-004-24: Compact Wheel Loader w/ Attachments

3 messages

GWSA Procurement <procurement@gswa.guam.gov>

14 November 2023 at 14:07

To: USA Contractors Corporation <sales@usacontractorscorp.com>

Cc: Alicia Fejeran <alicia.fejeran@gswa.guam.gov>, Keilani Mesa <keilani.mesa@gswa.guam.gov>

Håfa Adai!

Please see attached Questions & Concerns in regards to the above-mentioned IFB for your reference. Please sign the acknowledgement on the bottom of the page & submit back at your earliest convenience.

Thank you!

*Si Yu'os Ma'åse,***Camaryn Aguon****Buyer I****GUAM SOLID WASTE AUTHORITY**

546 N. Marine Corps Dr., Tamuning, Guam 96913

T: (671) 646-3111 | F: (671) 649-3777

W: www.gswa.guam.gov

GWSA-004-24 Q&C - 11.14.2023.pdf
34K
FILE

USA Contractors Corporation <sales@usacontractorscorp.com>

16 November 2023 at 14:13

To: GWSA Procurement <procurement@gswa.guam.gov>

Cc: Alicia Fejeran <alicia.fejeran@gswa.guam.gov>, Keilani Mesa <keilani.mesa@gswa.guam.gov>, Jose Marimla <jose.marimla2@medpharmusa.net>

Hafa Adai Camaryn,

Please see the attached file.

Best Regards,

Eddie Onopey

Sales Representative

Cell No. (671) 727-8700

E-mail. sales@usacontractorscorp.com



138 Kayen Chando St. Dededo GU 96929

1.3 6719632.3044 FAX: 671 49000

CONFIDENTIALITY: This email message contains confidential, privileged information and is for the sole use of the intended recipient(s) authorized by MedPharm. Any unauthorized review, use, disclosure or distribution of this email and attachment is prohibited. If you are not the intended recipient, please contact the sender by return email and destroy all paper and electronic copies of the original message.

From: GSWA Procurement <procurement@gswa.guam.gov>
Sent: Tuesday, November 14, 2023 2:07 PM
To: USA Contractors Corporation <sales@usacontractorscorp.com>
Cc: Alicia Fejeran <alicia.fejeran@gswa.guam.gov>; Keilani Mesa <keilani.mesa@gswa.guam.gov>
Subject: GSWA-004-24: Compact Wheel Loader w/ Attachments

[Quoted text hidden]

 **GSWA-004-24 Q&C - 11.14.2023.pdf**
36K

GSWA Procurement <procurement@gswa.guam.gov> 16 November 2023 at 14:26
To: USA Contractors Corporation <sales@usacontractorscorp.com>
Cc: Alicia Fejeran <alicia.fejeran@gswa.guam.gov>, Keilani Mesa <keilani.mesa@gswa.guam.gov>, Jose Marimla <jose.marimla2@medpharmusa.net>

Received, thank you!

Best Regards,
Camaryn

[Quoted text hidden]

FILE



GWSA Procurement <procurement@gswa.guam.gov>

GWSA-004-24: Compact Wheel Loader w/ Attachments

3 messages

GWSA Procurement <procurement@gswa.guam.gov>

14 November 2023 at 13:01

To: USA Contractors Corporation <sales@usacontractorscorp.com>

Cc: Alicia Fejeran <alicia.fejeran@gswa.guam.gov>, Keilani Mesa <keilani.mesa@gswa.guam.gov>

Håfa Adai!

Please see attached Amendment No. 1 for your reference. Please sign the acknowledgement portion on the second page & submit back at your earliest convenience.

Thank you!

*Si Yu'os Ma'åse,***Camaryn Aguon****Buyer I****GUAM SOLID WASTE AUTHORITY**

546 N. Marine Corps Dr., Tamuning, Guam 96913

T: 671-646-3111 | F: 671-649-3777

W: www.gswa.guam.gov

GWSA-004-24 Amendment No. 1.pdf
45K
FILE**USA Contractors Corporation** <sales@usacontractorscorp.com>

16 November 2023 at 14:14

To: GWSA Procurement <procurement@gswa.guam.gov>

Cc: Alicia Fejeran <alicia.fejeran@gswa.guam.gov>, Keilani Mesa <keilani.mesa@gswa.guam.gov>, Jose Marimla <jose.marimla2@medpharmusa.net>

Hafa Adai Camaryn,

Thank you for your email. Please see attached file.

Best Regards,

Eddie Onopey

Sales Representative

Cell No. (671) 727-8700

E-mail. sales@usacontractorscorp.com



138 Kayen Chando St. Dededo GU 96929

Tel. 671.632.3044 Fax. 671.632.9000

CONFIDENTIALITY: This email message contains confidential, privileged information and is for the use of the intended recipient(s) authorized by MedPharm. Any unauthorized review, use, disclosure or distribution of this email and attachment is prohibited. If you are not the intended recipient, please contact the sender by return email and destroy all paper and electronic copies of the original message.

From: GSWA Procurement <procurement@gswa.guam.gov>
Sent: Tuesday, November 14, 2023 1:01 PM
To: USA Contractors Corporation <sales@usacontractorscorp.com>
Cc: Alicia Fejeran <alicia.fejeran@gswa.guam.gov>; Keilani Mesa <keilani.mesa@gswa.guam.gov>
Subject: GSWA-004-24: Compact Wheel Loader w/ Attachments

[Quoted text hidden]

 **GSWA-004-24 Amendment No. 1.pdf**
47K

GSWA Procurement <procurement@gswa.guam.gov> 16 November 2023 at 14:26
To: USA Contractors Corporation <sales@usacontractorscorp.com>
Cc: Alicia Fejeran <alicia.fejeran@gswa.guam.gov>, Keilani Mesa <keilani.mesa@gswa.guam.gov>, Jose Marimla <jose.marimla2@medpharmusa.net>

Received, thank you!

Best Regards,

Camaryn

[Quoted text hidden]





FILE

GWSA Procurement <procurement@gswa.guam.gov>

Tink Claw Bucket - GSWA-004-24

7 messages

Ryne Santos <rsantos@fareastequipment.com>
 To: GSWA Procurement <procurement@gswa.guam.gov>
 Cc: John Limtiaco <jlimtiaco@fareastequipment.com>

17 November 2023 at 12:46

Hafa Adai GSWA Procurement:

The manufacturer of the Tink Claw bucket does not recommend the C720 (2.7CYD) model for this size machine. They recommend the C520 (1.2 CYD) model for a machine of this size. With this information, does GSWA want to proceed with a C720 model bucket though it may pose a tipping hazard?

--Best regards,
 Ryne-Paul Santos
 Sales
 Far East Equipment Co. LLC
 P.O. Box 10838
 Tamuning, Guam 96931



GWSA Procurement <procurement@gswa.guam.gov>
 To: Irvin Slike <irvin.slike@gswa.guam.gov>

20 November 2023 at 09:00

FYI.
 [Quoted text hidden]

GWSA Procurement <procurement@gswa.guam.gov>
 To: Alicia Fejeran <alicia.fejeran@gswa.guam.gov>

20 November 2023 at 09:00

----- Forwarded message -----
 From: **Ryne Santos** <rsantos@fareastequipment.com>
 Date: Fri, 17 Nov 2023 at 12:46
 Subject: Tink Claw Bucket - GSWA-004-24
 To: GSWA Procurement <procurement@gswa.guam.gov>
 Cc: John Limtiaco <jlimtiaco@fareastequipment.com>

[Quoted text hidden]

Irvin Slike <irvin.slike@gswa.guam.gov>
 To: GSWA Procurement <procurement@gswa.guam.gov>, Roman Perez <roman.perez@gswa.guam.gov>

20 November 2023 at 09:18

The 520 bucket is acceptable
 [Quoted text hidden]

 Alicia Fejeran <alicia.fejeran@gswa.guam.gov>
To: GSWA Procurement <procurement@gswa.guam.gov>

20 November 2023 at 10:06

Irv said to entertain this question so we will amend due date for Q's and respond.

answer is no, we want to go with a C520 model bucket.

Thanks,
Alicia

[Quoted text hidden]

Alicia Fejeran <alicia.fejeran@gswa.guam.gov>
To: GSWA Procurement <procurement@gswa.guam.gov>

20 November 2023 at 10:06

Tink 520 or equal.

Thanks,
Alicia

[Quoted text hidden]

GSWA Procurement <procurement@gswa.guam.gov>
To: Keilani Mesa <keilani.mesa@gswa.guam.gov>

20 November 2023 at 16:36

FYI

[Quoted text hidden]

FILE

GWSA Procurement <procurement@gswa.guam.gov>

GWSA-004-24: Compact Wheel Loader w/ Attachments

3 messages

GWSA Procurement <procurement@gswa.guam.gov>

20 November 2023 at 10:13

To: Roman Perez <roman.perez@gswa.guam.gov>, Dennis Mendiola <dennis.mendiola@gswa.guam.gov>, Julie Cruz <julie.cruz@gswa.guam.gov>

Cc: Alicia Fejeran <alicia.fejeran@gswa.guam.gov>

Håfa Adai!

Please see attached Questions & Concerns from Morrico Equipment. The responses in green are what Alicia researched regarding rise & fall single wheel. Please advise at your earliest convenience if we can change the answers to what's written in green font.

Thank you!

*Si Yu'os Ma'åse,***Camaryn Aguon****Buyer I****GUAM SOLID WASTE AUTHORITY**

546 N. Marine Corps Dr., Tamuning, Guam 96913

T: (671) 646-3111 | F: (671) 649-3777

W: www.gswa.guam.gov **GWSA-004-24 Q&C - 11.16.2023 avf.docx**
92K**Julie Cruz** <julie.cruz@gswa.guam.gov>

20 November 2023 at 10:25

To: GWSA Procurement <procurement@gswa.guam.gov>

Cc: Roman Perez <roman.perez@gswa.guam.gov>, Dennis Mendiola <dennis.mendiola@gswa.guam.gov>, Alicia Fejeran <alicia.fejeran@gswa.guam.gov>

Good morning,

Let me get with Roman and Dennis in regards to this.

Thanks!

[Quoted text hidden]

--

JulieMarie Cruz**Operation Secretary II****Guam Solid Waste Authority**

542 N. Marine Corps Dr. Tumon, GU 96913

Customer Service: 671-646-3111

Operations: 671-588-3112

Fax: 671-649-3777

Website: www.guamsolidwasteauthority.com**dennis.mendiola** <dennis.mendiola@gswa.guam.gov>

20 November 2023 at 10:49

To: Julie Cruz <julie.cruz@gswa.guam.gov>, GWSA Procurement <procurement@gswa.guam.gov>



Yes the response in green is correct. The highest lift point for loading and the lowest drop point digging.

Sent from my Galaxy
[Quoted text hidden]

GWSA Procurement <procurement@gswa.guam.gov> **FILE****GWSA-004-24: Compact Wheel Loader w/ Attachments**

1 message

GWSA Procurement <procurement@gswa.guam.gov>

20 November 2023 at 17:09

To: John Limtiaco <jlimtiaco@fareastequipment.com>, Ryne Santos <rsantos@fareastequipment.com>

Cc: Alicia Fejeran <alicia.fejeran@gswa.guam.gov>, Keilani Mesa <keilani.mesa@gswa.guam.gov>, Irvin Slike <irvin.slike@gswa.guam.gov>

Håfa Adai!

Please see attached documents for your reference:

- Questions & Concerns
- Amendment No. 2

Please sign the acknowledgement portion on the bottom of the page & submit back at your earliest convenience.

Thank you!

*Si Yu'os Ma'åse,***Camaryn Aguon****Buyer I****GUAM SOLID WASTE AUTHORITY**

546 N. Marine Corps Dr., Tamuning, Guam 96913

T: (671) 646-3111 | F: (671) 649-3777

W: www.gswa.guam.gov

2 attachments **GWSA-004-24 Q&C - 11.20.2023.pdf**
81K **GWSA-004-24 Amendment No. 2.pdf**
156K

**FILE**

GWSA Procurement <procurement@gswa.guam.gov>

GWSA-004-24: Compact Wheel Loader w/ Attachments

1 message

GWSA Procurement <procurement@gswa.guam.gov>

20 November 2023 at 17:09

To: USA Contractors Corporation <sales@usacontractorscorp.com>

Cc: Alicia Fejeran <alicia.fejeran@gswa.guam.gov>, Keilani Mesa <keilani.mesa@gswa.guam.gov>, Irvin Slike <irvin.slike@gswa.guam.gov>

Håfa Adai!

Please see attached documents for your reference:

- Questions & Concerns
- Amendment No. 2

Please sign the acknowledgement portion on the bottom of the page & submit back at your earliest convenience.

Thank you!

*Si Yu'os Ma'åse,***Camaryn Aguon****Buyer I****GUAM SOLID WASTE AUTHORITY**

546 N. Marine Corps Dr., Tamuning, Guam 96913

T: (671) 646-3111 | F: (671) 649-3777

W: www.gswa.guam.gov**2 attachments** **GWSA-004-24 Q&C - 11.20.2023.pdf**
81K **GWSA-004-24 Amendment No. 2.pdf**
156K

**FILE**

GWSA Procurement <procurement@gswa.guam.gov>

GWSA-004-24: Compact Wheel Loader w/ Attachments

1 message

GWSA Procurement <procurement@gswa.guam.gov>

20 November 2023 at 17:09

To: Paul Eustaquio <paul@morricoequipment.com>

Cc: Alicia Fejeran <alicia.fejeran@gswa.guam.gov>, Keilani Mesa <keilani.mesa@gswa.guam.gov>, Irvin Slike <irvin.slike@gswa.guam.gov>

Håfa Adai!

Please see attached documents for your reference:

- Questions & Concerns
- Amendment No. 2

Please sign the acknowledgement portion on the bottom of the page & submit back at your earliest convenience.

Thank you!

*Si Yu'os Ma'åse,***Camaryn Aguon****Buyer I****GUAM SOLID WASTE AUTHORITY**

546 N. Marine Corps Dr., Tamuning, Guam 96913

T: (671) 646-3111 | F: (671) 649-3777

W: www.gswa.guam.gov

2 attachments**GWSA-004-24 Q&C - 11.20.2023.pdf**

81K

**GWSA-004-24 Amendment No. 2.pdf**

156K

**GWSA-004-24: Compact Wheel Loader w/ Attachments**

1 message

GWSA Procurement <procurement@gswa.guam.gov>

20 November 2023 at 17:09

To: Jimmy Cruz <JPCRUZ@hawthornecat.com>

Cc: Alicia Fejeran <alicia.fejeran@gswa.guam.gov>, Keilani Mesa <keilani.mesa@gswa.guam.gov>, Irvin Slike <irvin.slike@gswa.guam.gov>

Håfa Adai!

Please see attached documents for your reference:

- Questions & Concerns
- Amendment No. 2

Please sign the acknowledgement portion on the bottom of the page & submit back at your earliest convenience.

Thank you!

*Si Yu'os Ma'åse,***Camaryn Aguon****Buyer I****GUAM SOLID WASTE AUTHORITY**

546 N. Marine Corps Dr., Tamuning, Guam 96913

T: (671) 646-3111 | F: (671) 649-3777

W: www.gswa.guam.gov

2 attachments **GWSA-004-24 Q&C - 11.20.2023.pdf**
81K **GWSA-004-24 Amendment No. 2.pdf**
156K

**FILE**

GWSA Procurement <procurement@gswa.guam.gov>

GWSA-004-24: Compact Wheel Loader w/ Attachments

1 message

GWSA Procurement <procurement@gswa.guam.gov>

20 November 2023 at 17:10

To: "Mark S. Cruz" <mcruz@midpacfareast.com>

Cc: Alicia Fejeran <alicia.fejeran@gswa.guam.gov>, Keilani Mesa <keilani.mesa@gswa.guam.gov>, Irvin Slike <irvin.slike@gswa.guam.gov>

Håfa Adai!

Please see attached documents for your reference:

- Questions & Concerns
- Amendment No. 2

Please sign the acknowledgement portion on the bottom of the page & submit back at your earliest convenience.

Thank you!

*Si Yu'os Ma'åse,***Camaryn Aguon****Buyer I****GUAM SOLID WASTE AUTHORITY**

546 N. Marine Corps Dr., Tamuning, Guam 96913

T: (671) 646-3111 | F: (671) 649-3777

W: www.gswa.guam.gov**2 attachments** **GWSA-004-24 Amendment No. 2.pdf**
156K **GWSA-004-24 Q&C - 11.20.2023.pdf**
81K

FILE

GWSA Procurement <procurement@gswa.guam.gov>

GWSA-004-24: Compact Wheel Loader w/ Attachments

USA Contractors Corporation <sales@usacontractorscorp.com>

21 November 2023 at 15:53

To: GSWA Procurement <procurement@gswa.guam.gov>

Cc: Alicia Fejeran <alicia.fejeran@gswa.guam.gov>, Keilani Mesa <keilani.mesa@gswa.guam.gov>, Irvin Slike <irvin.slike@gswa.guam.gov>, Jose Marimla <jose.marimla2@medpharmusa.net>

Hafa Adai Camaryn,

Please see the attached files.



Best Regards,

Eddie Onopey

Sales Representative

Cell No. (671) 727-8700

E-mail. sales@usacontractorscorp.com



138 Kayen Chando St. Dededo GU 96929

Tel. 671.632.3044 Fax. 671.632.9000

CONFIDENTIALITY: This email message contains confidential, privileged information and is for the sole use of the intended recipient(s) authorized by MedPharm. Any unauthorized review, use, disclosure or distribution of this email and attachment is prohibited. If you are not the intended recipient, please contact the sender by return email and destroy all paper and electronic copies of the original message.

From: GSWA Procurement <procurement@gswa.guam.gov>**Sent:** Monday, November 20, 2023 5:09 PM**To:** USA Contractors Corporation <sales@usacontractorscorp.com>**Cc:** Alicia Fejeran <alicia.fejeran@gswa.guam.gov>; Keilani Mesa <keilani.mesa@gswa.guam.gov>; Irvin Slike <irvin.slike@gswa.guam.gov>**Subject:** GSWA-004-24: Compact Wheel Loader w/ Attachments

**FILE**

GSWA Procurement <procurement@gswa.guam.gov>

Procurement Packet: Morrico Equipment LLC GSWA-004-24

1 message

GSWA Procurement <procurement@gswa.guam.gov>

22 November 2023 at 12:31

To: submissions@guamwebz.com

A Procurement Packet has been requested from the website. Below is the copy of the email sent to the user who made the request.

Hafa Adai Paul Eustaquio,

You requested a Procurement Packet from the website.

Click the link(s) listed below to Download and View the Procurement Packet file(s) for:
> Download Link: [IFB NO. GSWA-004-24](#)

Procurement Number: GSWA-004-24
Title/Description: COMPACT WHEEL LOADER

REQUESTED BY:

First Name: Paul

Last Name: Eustaquio

Company: Morrico Equipment LLC

Address: 197 Ypao Road

Email: paul@morricoequipment.com

Telephone: +16714830180

Fax Number:



<https://guamsolidwasteauthority.com>



GUAM SOLID WASTE AUTHORITY

LOURDES A. LEON GUERRERO
Governor of Guam

JOSHUA F. TENORIO
Lt. Governor of Guam

IRVIN L. SLIKE
General Manager

FILE



November 20, 2023

INVITATION FOR BID GWSA-004-24 COMPACT WHEEL LOADER W/ ATTACHMENTS

Questions and Concerns received from Morrico Equipment on November 15, 2023

1. Axles: Fixed, 100% differential, manually engaged front axle, fixed conventional differential rear axle. Is an oscillating rear axle acceptable?

Response: Yes, refer to Amendment No. 2.

2. Max rise and fall single wheel: 15 inches maximum, 14 inches minimum. Please clarify what is required by the term listed above.

Response: The term "Max rise and fall single wheel: 15 inches maximum, 14 inches minimum" pertains to the vertical movement capability of a single wheel on the compact wheel loader. Here's a breakdown of the requirement:

- **Max Rise:** This refers to the maximum vertical distance the center of a single wheel is allowed to move upward from its resting position. In this context, the specified maximum rise is 15 inches.
- **Min Fall:** Conversely, the minimum fall denotes the minimum vertical distance the center of a single wheel is permitted to move downward from its resting position. For this specification, the minimum fall is 14 inches.

These parameters are crucial for ensuring that the compact wheel loader can effectively navigate varied terrains, accommodate different load sizes, and maintain stability during operation.

3. Hydraulically Driven, proportionally controlled fan. Will a belt driven fan be acceptable?

Response: Yes, refer to Amendment No. 2.

4. Voltage: 12-volt. Will a 24 Volt Electrical System be acceptable?

Response: Yes, refer to Amendment No. 2.

5. One (1) Battery. Will two 12-volt batteries be acceptable?

Response: Yes, refer to Amendment No. 2.

6. Battery Capacity: 925 CCA. Will two batteries with 900 CCA be acceptable?

Response: Yes, refer to Amendment No. 2.



GUAM SOLID WASTE AUTHORITY

LOURDES A. LEON GUERRERO
Governor of Guam

JOSHUA F. TENORIO
1st Governor of Guam

IRVIN L. SLIKE
General Manager



7. Seat: Air Ride high back with head rest and dual lumbar support. Will a mechanical suspension seat be acceptable?

Response: Yes, refer to Amendment No. 2.

8. 1.4 CY Bucket: 12,800 lbs. Maximum. Please confirm if this bucket request is for a multipurpose bucket.

Response: Refer to Amendment No. 2.

9. One (1) 1.4 CY Bucket with Bolt on Cutting Edge. Please confirm if this bucket request is for a Multipurpose Bucket. Please confirm if this is bucket request is additional to Question 8 bucket request or the same request.

Response: Refer to Amendment No. 2.

Questions and Concerns received from Far East Equipment Co. on November 17, 2023

10. The manufacturer of the Tink Claw bucket does not recommend the C720 (2.7CYD) model for this size machine. They recommend the C520 (1.2CYD) model for a machine of this size. With this information, does GSWA want to proceed with a C720 model bucket though it may pose a tipping hazard?

Response: No, refer to Amendment No. 2.

Irvin L. Slike,
General Manager

ACKNOWLEDGEMENT RECEIPT	
Return to GSWA by email or fax.	
Received By	Ryne Paul Santos
Date:	11/22/23
Company Name	Far East Equipment Co. LLC
Fax to: 671 649 3777	
Email: procurement@gswa.guam.gov	



GUAM SOLID WASTE AUTHORITY

FILE



LOURDES A. LEON GUERRERO
Governor of Guam

JOSHUA F. TENORIO
Lt. Governor of Guam

IRVIN L. SLIKE
General Manager

November 20, 2023

INVITATION FOR BID GSWA-004-24 COMPACT WHEEL LOADER W/ ATTACHMENTS

AMENDMENT NO. 2

1. Amend page 31 of 34

From:

Deadline for Receipt of Written Questions
must be e-mailed to the Guam Solid Waste Authority at
procurement@gswa.guam.gov, ATTN: General Manager

Wednesday, November 15, 2023
on or before 5:00PM
Chamorro Standard Time

To Now Read:

Deadline for Receipt of Written Questions
must be e-mailed to the Guam Solid Waste Authority at
procurement@gswa.guam.gov, ATTN: General Manager

Tuesday, November 21, 2023
on or before 5:00PM
Chamorro Standard Time

2. Amend page 31 of 34

From:

Bid Due Date & Bid Opening at the Guam Solid Waste
Authority: Administration Office, GSWA Bldg., 2nd Fl.
546 N. Marine Corps Dr., Tamuning, Guam

Wednesday, November 22, 2023
at 1:00PM
Chamorro Standard Time

To Now Read:

Bid Due Date & Bid Opening at the Guam Solid Waste
Authority: Administration Office, GSWA Bldg., 2nd Fl.
546 N. Marine Corps Dr., Tamuning, Guam

Tuesday, November 28, 2023
at 1:00PM
Chamorro Standard Time

3. Amend to replace pages 32 of 34 through 34 of 34 with the "Revised 11/20/2023 Page 32" through "Revised 11/20/2023 Page 34" attached.

*All others remain the same.

Irvin L. Slike,
General Manager

ACKNOWLEDGEMENT RECEIPT	
Return to GSWA by email or fax.	
Received By	<i>Ryne Paul Santos</i>
Date	<i>11/22/23</i>
Company Name	<i>Far East Equipment Co. LLC</i>
Fax to: 671 649 3777	
Email: procurement@gswa.guam.gov	



GUAM SOLID WASTE AUTHORITY

LOURDES A. LEON GUERRERO
Governor of Guam

JOSHUA F. TENORIO
Governor of Guam

IRVIN L. SLIKE
General Manager



COMPLY / NON-COMPLIANCE

Air conditioning

Steering: Dual tilt and telescoping steering column

Performance: Conforms with SAE J1040, SAE J231, ISO 3471 and ISO 3449 ROPS/FOPS

Operating Weight:

ISO quick coupler and 1CY general purpose bucket / bolt on edge 12,250 lbs. minimum

1.4 CY multi-purpose bucket: 12,800 lbs. maximum

Wheelbase: 7 feet minimum

Dump clearance: 40-degree full height – 8 feet 3 inches

Reach: 40-degree full height – 32 inches

Fork height fully raised: 10 feet minimum

Fork tipping load straight: 7000 lb. maximum

Attachments:

ISO quick coupling mechanism: Conforms with ISO 16028

One (1) additional 1.4 CY bucket with bolt on edge

One (1) Tink claw bucket model 520 or equal

One (1) 60-inch pick-up broom: 800 lb. minimum; 900 lb. max

One (1) Fork: 48 inches minimum

Equipment Warranty:

The Bidder guarantees to the Purchaser that the equipment, upon delivery, will be brand new and will have been constructed using entirely new components. Furthermore, the Bidder assures that any new equipment provided shall be free from any defects in manufacturing workmanship and materials for a duration of 24 months or 2,000 hours, whichever occurs first, commencing from the date of equipment delivery. This warranty encompasses any necessary repairs or replacements without any additional cost to the Purchaser.

Miscellaneous Items:

One (1) operator's manual hardcopy



GUAM SOLID WASTE AUTHORITY



LOURDES A. LEON GUERRERO
Governor of Guam

JOSHUA F. TENORIO
Lt. Governor of Guam

IRVIN L. SLIKE
General Manager

Delivered with a full tank of fuel _____

Note: The GSA Federal Contract will be considered along with its terms and conditions if offered.

Bidding On:

Manufacturer: _____

Year: _____

Model: _____

Place of Origin: _____

Date of Delivery: _____

**Request for Extension - GSWA-004-24**

3 messages

Ryne Santos <rsantos@fareastequipment.com>

24 November 2023 at 16:46

To: GSWA Procurement <procurement@gsa.guam.gov>

Cc: Marisa Reyes <mreyes@fareastequipment.com>, John Limtiaco <jlimtiaco@fareastequipment.com>

Hafa Adai GSWA Procurement:

We kindly request an extension for the bid GSWA-004-24 Compact Wheel Loader due to the recent changes in spec in Amendment 2. We are still waiting to hear from our manufacturers due to the Thanksgiving holidays. We request to extend the bid from 11/28/23 to 12/5/23.

--Best regards & Happy Holidays,

Ryne-Paul Santos

Sales

Far East Equipment Co. LLC

P.O. Box 10838

Tamuning, Guam 96931

**GSWA Procurement** <procurement@gsa.guam.gov>

27 November 2023 at 08:17

To: Alicia Fejeran <alicia.fejeran@gsa.guam.gov>, Irvin Slike <irvin.slike@gsa.guam.gov>

FYI.

[Quoted text hidden]

Irvin Slike <irvin.slike@gsa.guam.gov>

27 November 2023 at 08:20

To: GSWA Procurement <procurement@gsa.guam.gov>

I'm OK with this

[Quoted text hidden]

**GWSA-004-24: Compact Wheel Loader w/ Attachments**

1 message

GWSA Procurement <procurement@gswa.guam.gov>

27 November 2023 at 14:27

To: Paul Eustaquio <paul@morricoequipment.com>

Cc: Alicia Fejeran <alicia.fejeran@gswa.guam.gov>, Keilani Mesa <keilani.mesa@gswa.guam.gov>, Irvin Slike <irvin.slike@gswa.guam.gov>

Håfa Adai!

Please see attached Amendment No. 3 for your reference. Please sign the acknowledgement portion on the bottom of the page & submit back at your earliest convenience.

Thank you!

*Si Yu'os Ma'åse,***Camaryn Aguon****Buyer I****GUAM SOLID WASTE AUTHORITY**

546 N. Marine Corps Dr., Tamuning, Guam 96913

T: 671-646-3111 | F: 671-649-3777

W: www.gswa.guam.gov

GWSA-004-24 Amendment No. 3.pdf

35K

FILE



GSWA Procurement <procurement@gswa.guam.gov>

GSWA-004-24: Compact Wheel Loader w/ Attachments

1 message

GSWA Procurement <procurement@gswa.guam.gov>

27 November 2023 at 14:27

To: Ryne Santos <rsantos@fareastequipment.com>, John Limtiaco <jlimtiaco@fareastequipment.com>

Cc: Alicia Fejeran <alicia.fejeran@gswa.guam.gov>, Keilani Mesa <keilani.mesa@gswa.guam.gov>, Irvin Slike <irvin.slike@gswa.guam.gov>

Håfa Adai!

Please see attached Amendment No. 3 for your reference. Please sign the acknowledgement portion on the bottom of the page & submit back at your earliest convenience.

Thank you!

*Si Yu'os Ma'åse,***Camaryn Aguon****Buyer I****GUAM SOLID WASTE AUTHORITY**

546 N. Marine Corps Dr., Tamuning, Guam 96913

T: 671-646-3111 | F: 671-649-3777

W: www.gswa.guam.gov **GSWA-004-24 Amendment No. 3.pdf**

35K

**FILE****GWSA-004-24: Compact Wheel Loader w/ Attachments**

1 message

GWSA Procurement <procurement@gswa.guam.gov>

27 November 2023 at 14:28

To: Jimmy Cruz <JPCRUZ@hawthornecat.com>

Cc: Alicia Fejeran <alicia.fejeran@gswa.guam.gov>, Keilani Mesa <keilani.mesa@gswa.guam.gov>, Irvin Slike <irvin.slike@gswa.guam.gov>

Håfa Adai!

Please see attached Amendment No. 3 for your reference. Please sign the acknowledgement portion on the bottom of the page & submit back at your earliest convenience.

Thank you!

*Si Yu'os Ma'åse,***Camaryn Aguon****Buyer I****GUAM SOLID WASTE AUTHORITY**

546 N. Marine Corps Dr., Tamuning, Guam 96913

T: 671-646-3111 | F: 671-649-3777

W: www.gswa.guam.gov

GWSA-004-24 Amendment No. 3.pdf

35K



GWSA Procurement <procurement@gswa.guam.gov>

FILE**GWSA-004-24: Compact Wheel Loader w/ Attachments**

1 message

GWSA Procurement <procurement@gswa.guam.gov>

27 November 2023 at 14:28

To: USA Contractors Corporation <sales@usacontractorscorp.com>

Cc: Alicia Fejeran <alicia.fejeran@gswa.guam.gov>, Keilani Mesa <keilani.mesa@gswa.guam.gov>, Irvin Slike <irvin.slike@gswa.guam.gov>

Håfa Adai!

Please see attached Amendment No. 3 for your reference. Please sign the acknowledgement portion on the bottom of the page & submit back at your earliest convenience.

Thank you!

*Sí Yu'os Ma'åse,***Camaryn Aguon****Buyer I****GUAM SOLID WASTE AUTHORITY**

546 N. Marine Corps Dr., Tamuning, Guam 96913

T: 671-646-3111 | F: 671-649-3777

W: www.gswa.guam.gov **GWSA-004-24 Amendment No. 3.pdf**

35K

**FILE****GSWA-004-24: Compact Wheel Loader w/ Attachments**

1 message

GWSA Procurement <procurement@gsua.guam.gov>

27 November 2023 at 14:31

To: "Mark S. Cruz" <mcruz@midpacfareast.com>

Cc: Alicia Fejeran <alicia.fejeran@gsua.guam.gov>, Keilani Mesa <keilani.mesa@gsua.guam.gov>, Irvin Slike <irvin.slike@gsua.guam.gov>, Chris Camacho <ccamacho@midpacfareast.com>

Håfa Adai!

Please see attached Amendment No. 3 for your reference. Please sign the acknowledgement portion on the bottom of the page & submit back at your earliest convenience.

Thank you!

*Si Yu'os Ma'åse,***Camaryn Aguon****Buyer I****GUAM SOLID WASTE AUTHORITY**

546 N. Marine Corps Dr., Tamuning, Guam 96913

T: 671-646-3111 | F: 671-649-3777

W: www.gswa.guam.gov

GSWA-004-24 Amendment No. 3.pdf

35K

FILE

GWSA Procurement <procurement@gswa.guam.gov>

GWSA-004-24: Compact Wheel Loader w/ Attachments

3 messages

GWSA Procurement <procurement@gswa.guam.gov>

27 November 2023 at 14:27

To: Paul Eustaquio <paul@morricoequipment.com>

Cc: Alicia Fejeran <alicia.fejeran@gswa.guam.gov>, Keilani Mesa <keilani.mesa@gswa.guam.gov>, Irvin Slike <irvin.slike@gswa.guam.gov>

Håfa Adai!

Please see attached Amendment No. 3 for your reference. Please sign the acknowledgement portion on the bottom of the page & submit back at your earliest convenience.

Thank you!



Si Yu'os Ma'åse,
Camaryn Aguon
 Buyer I

GUAM SOLID WASTE AUTHORITY
 546 N. Marine Corps Dr., Tamuning, Guam 96913
 T: 671-646-3111 | F: 671-649-3777
 W: www.gswa.guam.gov

GWSA-004-24 Amendment No. 3.pdf
 35K

Paul Eustaquio <Paul@morricoequipment.com>

27 November 2023 at 14:46

To: GWSA Procurement <procurement@gswa.guam.gov>

Cc: Alicia Fejeran <alicia.fejeran@gswa.guam.gov>, Keilani Mesa <keilani.mesa@gswa.guam.gov>, Irvin Slike <irvin.slike@gswa.guam.gov>

Hello GSWA Team,

Please see attached acknowledgement for GSWA-004-24 Amendment # 3.

Regards,

Paul Eustaquio

Heavy Equipment Sales

Mobile: 671.483.0180



197 Ypao Road, Tamuning Guam 96913
 671.649.1946
 morricoequipment.com



This message and any attachments are intended only for the use of the addressee and may contain information that is privileged and confidential. If the reader of the message is not the intended recipient or an authorized representative of the intended recipient, you are hereby notified that any dissemination of this communication is strictly prohibited. If you have received this communication in error, please notify us immediately by e-mail and delete the message and any attachments from your system.



procurement@gswa.guam.gov

To: Paul Eustaquio <Paul@morricoequipment.com>

Cc: Alicia Fejeran <alicia.fejeran@gswa.guam.gov>; Keilani Mesa <keilani.mesa@gswa.guam.gov>; Irvin Slike <irvin.slike@gswa.guam.gov>

Subject: GSWA-004-24: Compact Wheel Loader w/ Attachments

[Quoted text hidden]

 Acknowledgement GSWA-004-24 Amendment No. 3.pdf
198K

GSWA Procurement <procurement@gswa.guam.gov>

27 November 2023 at 15:01

To: Paul Eustaquio <Paul@morricoequipment.com>

Cc: Alicia Fejeran <alicia.fejeran@gswa.guam.gov>, Keilani Mesa <keilani.mesa@gswa.guam.gov>, Irvin Slike <irvin.slike@gswa.guam.gov>

Received, thank you!

Best Regards,
Camaryn

[Quoted text hidden]

GWSA Procurement <procurement@gswa.guam.gov> **FILE****GWSA-004-24: Compact Wheel Loader w/ Attachments****USA Contractors Corporation** <sales@usacontractorscorp.com>

30 November 2023 at 14:31

To: GSWA Procurement <procurement@gswa.guam.gov>

Cc: Alicia Fejeran <alicia.fejeran@gswa.guam.gov>, Keilani Mesa <keilani.mesa@gswa.guam.gov>, Irvin Slike <irvin.slike@gswa.guam.gov>

Hafa Adai Camaryn,

Please see the attached file.

Best Regards,

Eddie Onopey

Sales Representative

Cell No. (671) 727-8700

E-mail. sales@usacontractorscorp.com

**CONTRACTORS INC.**

138 Kayen Chando St. Dededo GU 96929

Tel. 671.632.3044 Fax. 671.632.9000

CONFIDENTIALITY: This email message contains confidential, privileged information and is for the sole use of the intended recipient(s) authorized by MedPharm. Any unauthorized review, use, disclosure or distribution of this email and attachment is prohibited. If you are not the intended recipient, please contact the sender by return email and destroy all paper and electronic copies of the original message.

From: GSWA Procurement <procurement@gswa.guam.gov>**Sent:** Monday, November 27, 2023 2:28 PM**To:** USA Contractors Corporation <sales@usacontractorscorp.com>**Cc:** Alicia Fejeran <alicia.fejeran@gswa.guam.gov>; Keilani Mesa <keilani.mesa@gswa.guam.gov>; Irvin Slike <irvin.slike@gswa.guam.gov>**Subject:** GSWA-004-24: Compact Wheel Loader w/ Attachments

Hafa Adai!

Please see attached Amendment No. 3 for your reference. Please sign the acknowledgement portion on the bottom of the page & submit back at your earliest convenience.

Thank you!



Si Yu'os Ma'åse,
Camaryn Aguon
Buyer I
GUAM SOLID WASTE AUTHORITY
546 N. Marine Corps Dr., Tamuning, Guam 96913
T: 671-646-3111 | F: 671-649-3777
W: www.gswa.guam.gov

 **GSWA-004-24 Amendment No. 3.pdf**
37K



GSWA Procurement <procurement@gswa.guam.gov>

GSWA-004-24: Compact Wheel Loader w/ Attachments

3 messages

GSWA Procurement <procurement@gswa.guam.gov>

13 December 2023 at 10:31

To: John Limtiaco <jlimtiaco@fareastequipment.com>, Ryne Santos <rsantos@fareastequipment.com>, Marisa Reyes <mreyes@fareastequipment.com>

Cc: Alicia Fejeran <alicia.fejeran@gswa.guam.gov>, Keilani Mesa <keilani.mesa@gswa.guam.gov>, Irvin Slike <irvin.slike@gswa.guam.gov>

Håfa Adai!

Please see attached Notice of Intent of Possible Award regarding the above-mentioned subject. Kindly fill out the acknowledgement portion located on the bottom of the page & send back at your earliest convenience.

Thank you!

*Si Yu'os Ma'åse,***Camaryn Aguon****Buyer I****GUAM SOLID WASTE AUTHORITY**

546 N. Marine Corps Dr., Tamuning, Guam 96913

T: (671) 646-3111 | F: (671) 649-3777

W: www.gswa.guam.gov **GSWA-004-24 Notice of Intent of Possible Award.pdf**
1892K**mreyes@fareastequipment.com** <mreyes@fareastequipment.com>

14 December 2023 at 13:25

To: GSWA Procurement <procurement@gswa.guam.gov>, John Limtiaco <jlimtiaco@fareastequipment.com>, Ryne Santos <rsantos@fareastequipment.com>

Cc: Alicia Fejeran <alicia.fejeran@gswa.guam.gov>, Keilani Mesa <keilani.mesa@gswa.guam.gov>, Irvin Slike <irvin.slike@gswa.guam.gov>

Dear GSWA Procurement Team,

Please see attached acknowledgement for GSWA-004-24.

Thank you,

Marisa Wengu Reyes

Administrative Assistant

Far East Equipment Company, LLC

Tel: 671-475-1079



[Quoted text hidden]

 **GSWA-004-24_12142023113639.pdf**
261K

GSWA Procurement <procurement@gswa.guam.gov>

14 December 2023 at 13:56

To: mreyes@fareastequipment.com

Cc: John Limtiaco <jlimtiaco@fareastequipment.com>, Ryne Santos <rsantos@fareastequipment.com>, Alicia Fejeran <alicia.fejeran@gswa.guam.gov>, Keilani Mesa <keilani.mesa@gswa.guam.gov>, Irvin Slike <irvin.slike@gswa.guam.gov>

Received, thank you!

Best Regards,
Camaryn

[Quoted text hidden]

FILE



GSWA Procurement <procurement@gswa.guam.gov>

GSWA-004-24: Compact Wheel Loader w/ Attachments

2 messages

GSWA Procurement <procurement@gswa.guam.gov>

13 December 2023 at 10:31

To: Paul Eustaquio <paul@morricoequipment.com>

Cc: Alicia Fejeran <alicia.fejeran@gswa.guam.gov>, Keilani Mesa <keilani.mesa@gswa.guam.gov>, Irvin Slike <irvin.slike@gswa.guam.gov>

Håfa Adai!

Please see the attached Bid Status regarding the above-mentioned subject. Kindly fill out the acknowledgement portion located at the bottom of the page & send back at your earliest convenience.

Thank you!



Si Yu'os Ma'åse,

Camaryn Aguon

Buyer I

GUAM SOLID WASTE AUTHORITY

546 N. Marine Corps Dr., Tamuning, Guam 96913

T: (671) 646-3111 | F: (671) 649-3777

W: www.gswa.guam.gov

GSWA-004-24 Bid Status.pdf
2105K

Paul Eustaquio <Paul@morricoequipment.com>

13 December 2023 at 16:39

To: GSWA Procurement <procurement@gswa.guam.gov>

Cc: Alicia Fejeran <alicia.fejeran@gswa.guam.gov>, Keilani Mesa <keilani.mesa@gswa.guam.gov>, Irvin Slike <irvin.slike@gswa.guam.gov>, Ross Morrison <ross@morricoequipment.com>, Jesse Munoz <jesse.munoz@morricoequipment.com>

Hello GSWA Team,

Please see attached acknowledgment for GSWA-004-24 bid status.

Could you please confirm which of our specifications were non-conformance for this bid?

Regards,

Paul Eustaquio

Heavy Equipment Sales

Mobile: 671.483.0180



197 Ypao Road, Tamuning Guam 96913

671.649.1946

morricoequipment.com



If you are not the intended recipient, please do not disseminate, distribute or copy this e-mail. If the reader of the message is not the intended recipient or an authorized representative of the intended recipient, you are hereby notified that any dissemination of this communication is strictly prohibited. If you have received this communication in error, please notify us immediately by e-mail and delete the message and any attachments from your system.

From: GSWA Procurement <procurement@gswa.guam.gov>
Sent: Wednesday, December 13, 2023 10:32 AM
To: Paul Eustaquio <paul@morricoequipment.com>
Cc: Alicia Fejeran <alicia.fejeran@gswa.guam.gov>; Keilani Mesa <keilani.mesa@gswa.guam.gov>; Irvin Slike <irvin.slike@gswa.guam.gov>
Subject: GSWA-004-24: Compact Wheel Loader w/ Attachments

[Quoted text hidden]

 **Acknowledged GSWA-004-24 Bid Status.pdf**
36K

**FILE****GWSA-004-24: Compact Wheel Loader w/ Attachments**

Paul Eustaquio <Paul@morricequipment.com>

13 December 2023 at 16:39

To: GSWA Procurement <procurement@gswa.guam.gov>

Cc: Alicia Fejeran <alicia.fejeran@gswa.guam.gov>, Keilani Mesa <keilani.mesa@gswa.guam.gov>, Irvin Slike

<irvin.slike@gswa.guam.gov>, Ross Morrison <ross@morricequipment.com>, Jesse Munoz <jesse.munoz@morricequipment.com>

Hello GSWA Team,

Please see attached acknowledgment for GSWA-004-24 bid status.

Could you please confirm which of our specifications were non-conformance for this bid?

Regards,

Paul Eustaquio

Heavy Equipment Sales

Mobile: 671.483.0180



197 Ypao Road, Tamuning Guam 96913
671.649.1946
morricequipment.com



This message and any attachments are intended only for the use of the addressee and may contain information that is privileged and confidential. If the reader of the message is not the intended recipient or an authorized representative of the intended recipient, you are hereby notified that any dissemination of this communication is strictly prohibited. If you have received this communication in error, please notify us immediately by e-mail and delete the message and any attachments from your system.

From: GSWA Procurement <procurement@gswa.guam.gov>**Sent:** Wednesday, December 13, 2023 10:32 AM**To:** Paul Eustaquio <paul@morricequipment.com>**Cc:** Alicia Fejeran <alicia.fejeran@gswa.guam.gov>; Keilani Mesa <keilani.mesa@gswa.guam.gov>; Irvin Slike <irvin.slike@gswa.guam.gov>**Subject:** GSWA-004-24: Compact Wheel Loader w/ Attachments

[Quoted text hidden]

Acknowledged GSWA-004-24 Bid Status.pdf
36K

**FILE****GSWA-004-24: Compact Wheel Loader w/ Attachments****Paul Eustaquio** <Paul@morricequipment.com>

15 December 2023 at 15:29

To: GSWA Procurement <procurement@gswa.guam.gov>

Cc: Alicia Fejeran <alicia.fejeran@gswa.guam.gov>, Keilani Mesa <keilani.mesa@gswa.guam.gov>, Irvin Slike <irvin.slike@gswa.guam.gov>, Ross Morrison <ross@morricequipment.com>, Jesse Munoz <jesse.munoz@morricequipment.com>

Hello Camaryn,

Just wanted to follow up, could you please confirm which of our specifications were non-conformance for this bid?

Regards,

Paul Eustaquio

Heavy Equipment Sales

Mobile: 671.483.0180

197 Ypao Road, Tamuning Guam 96913
671.649.1946
morricequipment.com

This message and any attachments are intended only for the use of the addressee and may contain information that is privileged and confidential. If the reader of the message is not the intended recipient or an authorized representative of the intended recipient, you are hereby notified that any dissemination of this communication is strictly prohibited. If you have received this communication in error, please notify us immediately by e-mail and delete the message and any attachments from your system.

From: Paul Eustaquio**Sent:** Wednesday, December 13, 2023 4:39 PM**To:** GSWA Procurement <procurement@gswa.guam.gov>**Cc:** Alicia Fejeran <alicia.fejeran@gswa.guam.gov>; Keilani Mesa <keilani.mesa@gswa.guam.gov>; Irvin Slike <irvin.slike@gswa.guam.gov>; Ross Morrison <ross@morricequipment.com>; Jesse Munoz <jesse.munoz@morricequipment.com>**Subject:** RE: GSWA-004-24: Compact Wheel Loader w/ Attachments

Hello GSWA Team,

Please see attached acknowledgment for GSWA-004-24 bid status.

Could you please confirm which of our specifications were non-conformance for this bid?

Regards,

Paul Eustaquio



GSWA Procurement <procurement@gswa.guam.gov>

FILE**GSWA-004-24: Compact Wheel Loader w/ Attachments**

GSWA Procurement <procurement@gswa.guam.gov>

15 December 2023 at 16:54

To: Paul Eustaquio <Paul@morricoequipment.com>

Cc: Alicia Fejeran <alicia.fejeran@gswa.guam.gov>, Keilani Mesa <keilani.mesa@gswa.guam.gov>, Irvin Slike <irvin.slike@gswa.guam.gov>, Ross Morrison <ross@morricoequipment.com>, Jesse Munoz <jesse.munoz@morricoequipment.com>

Håfa Adai, Paul!

My apologies for the delay. Please see attached Revised Bid Status. Please sign the acknowledgement portion located at the bottom of the page & return at your earliest convenience.

Thank you & have a good weekend!

Best Regards,
Camaryn

[Quoted text hidden]

 **GSWA-004-24 Revised Bid Status.pdf**

38K



GWSA Procurement <procurement@gswa.guam.gov>

GSWA-004-24: Compact Wheel Loader w/ Attachments

Paul Eustaquio <Paul@morricequipment.com>

19 December 2023 at 17:48

To: GSWA Procurement <procurement@gswa.guam.gov>

Cc: Alicia Fejeran <alicia.fejeran@gswa.guam.gov>, Keilani Mesa <keilani.mesa@gswa.guam.gov>, Irvin Slike <irvin.slike@gswa.guam.gov>, Ross Morrison <ross@morricequipment.com>, Jesse Munoz <jesse.munoz@morricequipment.com>, Joel Lesh <Joel.Lesh@morricequipment.com>

Hello Camaryn,

Please see attached acknowledgement for revised bid status GSWA-004-24.

Please see attached FOIA request for Far East Equipment's Bid Packet for GSWA-004-24.

Regards,

Paul EustaquioHeavy Equipment Sales
671.483.0180

[Quoted text hidden]

[Quoted text hidden]

2 attachments **Acknowledgement GSWA-004-24 Revised Bid Status.pdf**
38K **FOIA Request GSWA-004-24.pdf**
1120K



Sales, Rental, Parts and Service

ADDRESS: 197 Ypao Road, Tamuning
Guam 96913
OFFICE: Phone: 1-671-649-1946
FAX: 1-671-649-1947
SPARE PARTS: Phone: 1-671-646-7914
Fax: 1-671-646-7900
WEB: www.morricoequipment.com



Freedom of Information Act Request

To : Irvin Slike
General Manager
Guam Solid Waste Authority
546 North Marine Corps Drive
Tamuning, Guam 96913

Email : Procurement@gswa.guam.gov
From : Paul Eustaquio / Ross Morrison

Date : December 19, 2023
Pages : 1 of 2

Re: Guam Solid Waste Authority Invitation for Bid GSWA-004-24 Compact Wheel Loader with Attachments

Dear Sir,

This request is under the freedom of information act. Morrico Equipment would like to request for a copy of Far East Equipment bid packet for bid # GSWA-004-24.

Paul Eustaquio

Heavy Equipment Sales
Morrico Equipment LLC
paul@morricoequipment.com
Cell (671) 483-0180

ON-SITE DIESEL DELIVERY





FOIA Request from Morrico

2 messages

Keilani Mesa <keilani.mesa@gswa.guam.gov> 20 December 2023 at 10:19
 To: Irvin Slike <irvin.slike@gswa.guam.gov>
 Cc: Alicia Fejeran <alicia.fejeran@gswa.guam.gov>, GSWA Procurement <procurement@gswa.guam.gov>

Hafa Adai Mr. Slike,

Please see the attached FOIA request we received today from Morrico regarding the wheel loader IFB GSWA-004-24 for your review and reference. If you have any questions, please let us know.

--



Respectfully,
Keilani Mesa
Administrative Officer
 GUAM SOLID WASTE AUTHORITY
 546 N. Marine Corps Dr. Tamuning, Guam 96913
 T: 671-646-3111 F: 671-649-3777 W: www.gswa.guam.gov

FOIA Request GSWA-004-24_.pdf
 3122K

Keilani Mesa <keilani.mesa@gswa.guam.gov> 21 December 2023 at 09:20
 To: Irvin Slike <irvin.slike@gswa.guam.gov>
 Cc: Alicia Fejeran <alicia.fejeran@gswa.guam.gov>, GSWA Procurement <procurement@gswa.guam.gov>

Hafa Adai Mr. Slike,

Sorry to bother you again. Just wanted to ensure you didn't miss this FOIA request. Thank you!

[Quoted text hidden]

FILE



GSWA Procurement <procurement@gswa.guam.gov>

IFB No. GSWA-004-24 - FOIA Request

1 message

GSWA Procurement <procurement@gswa.guam.gov>

21 December 2023 at 10:24

To: Paul Eustaquio <paul@morricoequipment.com>

Cc: Alicia Fejeran <alicia.fejeran@gswa.guam.gov>, Keilani Mesa <keilani.mesa@gswa.guam.gov>, Irvin Slike <irvin.slike@gswa.guam.gov>, Ross Morrison <ross@morricoequipment.com>, Jesse Munoz <jesse.munoz@morricoequipment.com>, Joel.Lesh@morricoequipment.com

Håfa Adai!

As requested, please see the attached FOIA Request Documents for your reference. Kindly acknowledge receipt of this email.

Thank you & have a great day!



Si Yu'os Ma'åse,

Camaryn Aguon

Buyer I

GUAM SOLID WASTE AUTHORITY

546 N. Marine Corps Dr., Tamuning, Guam 96913

T: (671) 646-3111 | F: (671) 649-3777

W: www.gswa.guam.gov

GSWA-004-24 FOIA Request.pdf
3122K



GUAM SOLID WASTE AUTHORITY

LOURDES A. LEON GUERRERO
Governor of Guam

JOSHUA F. TENORIO
Lt. Governor of Guam

IRVIN L. SLIKE
General Manager



December 20, 2023

VIA EMAIL: paul@morricoequipment.com

Paul Eustaquio
Heavy Equipment Sales
Morricco Equipment LLC

RE: FREEDOM OF INFORMATION ACT REQUEST

Dear Mr. Eustaquio,

Today the Guam Solid Waste Authority received your request for information under the provisions of the Freedom of Information Act (FOIA) dated December 19, 2023, as follows:

“This request is under the freedom of information act. Morricco Equipment would like to request for a copy of Far East Equipment bid packet for bid #GSWA-004-24”

Pursuant to the Sunshine Reform Act of 199, 5 GCA § 10101 – 10314, please find the attached bid packet from Far East Equipment received by GSWA regarding bid #GSWA-004-24, as requested, subject to the limitations on disclosure under 5 GCA § 10108.

If you have any questions or concerns, please do not hesitate to contact our office at 671-646-3215.

Sincerely,

IRVIN L. SLIKE
General Manager

FILE

PROCUREMENT PROTEST

ROBERTS FOWLER & VISOSKY LLP

865 S Marine Corps Drive, Ste. 201
Tamuning, Guam 96913

IRVIN L. SLIKE
GENERAL MANAGER
GUAM SOLID WASTE AUTHORITY
546 NORTH MARINE CORPS DR
TAMUNING, GUAM 96913



**Guam Solid Waste Authority
Procurement**

Date Received: 12/27/2023

Time Received: 2:48 PM

Received By: C. Roguon

ROBERTS FOWLER & VISOSKY LLP
ATTORNEYS AT LAW

TIM ROBERTS
KEVIN J. FOWLER
JON A. VISOSKY
SETH FORMAN

865 SOUTH MARINE CORPS DRIVE, SUITE 201
TAMUNING, GUAM 96913
TELEPHONE: (671) 646-1222
FACSIMILE: (671) 646-1223
www.guamlawoffice.com

Of Counsel:
MELINDA S. SWAVELY
DAVID W. DOOLEY

Writer's Direct Email:
fowler@guamlawoffice.com

December 27, 2023

PROCUREMENT PROTEST

VIA FACSIMILE TRANSMISSION
and HAND DELIVERY

Irvin L. Slike
General Manager
GUAM SOLID WASTE AUTHORITY
546 North Marine Corps Drive
Tamuning, Guam 96913



**Guam Solid Waste Authority
Procurement**

Date Received: 12/27/2023
Time Received: 2:48pm
Received By: C. Agum

RE: GSWA-004-24: 24 Compact Wheel Loader with Attachments

Dear Mr. Slike,

This office represents Morrico Equipment, LLC ("Morrico"), 197 Ypao Road, Tamuning, Guam 96913, with respect to GSWA-004-24, a procurement solicitation for a Compact Wheel Loader with Attachments (the "IFB"). Morrico hereby files its protest with respect to the IFB. The reasons for this protest are as follows.

The Guam Solid Waste Authority ("GSWA"), let the subject IFB on November 3, 2023. Morrico submitted its bid on the IFB offering a Case 221F Loader. However, in a "Bid Status" received by Morrico on December 13, 2023, the GSWA rejected the Morrico bid due to "Non-conformance with the specifications." The GSWA did not note which specification Morrico failed to meet. Morrico submitted a Deviation Letter with its bid. The GSWA specifications and Morrico's deviations thereto are as follows:

1) GSWA Specification:

Powertrain: Max rise and fall single wheel: 15 inches maximum, 14 inch minimum.

Morrico Deviation:

Morrico has a rise and fall single wheel of 11.8 inches for Case 221F Loader.

2) GSWA Specification:

Cooling: Hydraulically activated, self-adjusting internal wet disc brakes and driveline drum brake.

Morrigo Deviation:

Has a fan directly connected to the engine for Case 221F Loader.

3) GSWA Specification:

Operating Weight: 1.4 CY multi-purpose bucket: 12,800 lbs. maximum.

Morrigo Deviation:

Has 1.38 CY multi-purpose bucket.

4) GSWA Specification:

One (1) additional 1.4 CY bucket with bolt on edge.

Morrigo Deviation:

Werk Brau supplies a 1.25 CY General Purpose Bucket.

5) GSWA Specification:

One (1) 60-inch pick-up broom: 800lb. minimum; 900 lb. max.

Morrigo Deviation:

Smallest pick-up sweeper has a weight of 946 pounds.

6) GSWA Specification:

One (1) operator's manual on CD.

Morrigo Deviation:

Will supply a copy of the Operator's Manual on a USB Drive.

7) GSWA Specification:

One (1) Warranty Manual.

Morrigo Deviation:

Case does not provide a warranty manual.

8) GSWA Specification:

Online manual for parts, service & repair.

Morrigo Deviation:

This is a dealer only item. Only dealers are permitted to access the dealer portals. A digital copy of the parts, service, and repair manual will be supplied.

As noted above, GSWA did not advise Morrigo which of the foregoing deviations it relied on to reject Morrigo's bid.

However, Morrigo was not able to offer a product that met all specifications of the IFB, which is understandable since it cannot offer the John Deere 244P make and model on which GSWA based its specifications. In response to a question from Far East Equipment Company, LLC, GSWA advised that it based its specifications on a particular make and model of a compact loader, the "John Deere model 244P." But GSWA cannot restrictively apply the specifications of a particular manufacturer's product. Paragraph 19 of the IFB's General Terms and Conditions, provides as follows:

BRAND NAMES: Any reference in the Solicitation to manufacturer's Brand Names and number is due to lack of a satisfactory specification of commodity description. Such preference is intended to be descriptive, but not restrictive and for the sole purpose of indicating to prospective bidders a description of the article or services that will be satisfactory. Bids on comparable items will be considered provided the bidder clearly states in his bid the exact articles he is offering and how it differs from the original specification.

This "Brand Names" clause of the IFB's General Terms and Conditions, is an implementation of the provisions of 2 GAR § 4103(b)(2)(b), governing the use of brand names in specification development. But these regulations do not allow the application of brand name specifications in a restrictive manner. Instead, the specifications must be construed as descriptive only and must allow for the consideration for award of any substantially equivalent product. 2 GAR § 4103(b)(2)(b)(iii). The use of brand name specifications cannot be allowed to restrict competition. 2 GAR § 4103(b)(2)(b)(v).

5 GCA § 5265 provides that: "All specifications shall seek to promote overall economy for the purposes intended and encourage competition in satisfying the Territory's needs, and shall not be unduly restrictive." In addition, 5 GCA § 5268(a) provides that: "Specifications shall not include requirements, such as but not limited to restrictive dimensions, weights or materials, which unnecessarily restrict competition, and shall include only the essential physical characteristics and functions required to meet the Territory's minimum needs." An agency should avoid specifications

peculiar to one manufacturer and, instead, should develop specifications that "describe the salient technical requirements or desired performance characteristics of supplies or services to be procured without including restrictions which do not significantly affect the technical requirements or performance characteristics." 5 GCA § 5268(b) and (c).

The GSWA's application of the John Deere 244P specifications in a restrictive manner is in violation of the foregoing regulations and statutes. Restrictive application of the John Deere 244P specifications here has reduced competition, and will result in a tremendous increase in costs to the Territory. This is because the product that Morrigo bid was \$47,000 less expensive than the John Deere 244P offered by Far East Equipment. The minimum needs to be met by the GSWA are those that any loader would fulfill, and the loader offered by Morrigo meets those basic needs.

Accordingly, based on the foregoing, Morrigo respectfully requests that the GSWA accept the lesser priced loader offered by Morrigo. Please be advised that pursuant to 5 G.C.A. § 5425, you are not to proceed further with the procurement or award of a procurement contract prior to resolution of this bid protest.

Sincerely,

ROBERTS FOWLER & VISOSKY, LLP



Kevin J. Fowler



FILE

GWSA Procurement <procurement@gswa.guam.gov>

IFB No. GSWA-004-24: Compact Wheel Loader w/ Attachments

3 messages

GWSA Procurement <procurement@gswa.guam.gov>

27 December 2023 at 15:22

To: Irvin Slike <irvin.slike@gswa.guam.gov>

Cc: Alicia Fejeran <alicia.fejeran@gswa.guam.gov>

Håfa Adai, Mr. Slike!

Please see attached Procurement Protest (by Morrico Equipment) & Stay of Procurement (for your review) for the Compact Wheel Loader IFB. We will be delivering a copy to the AG's tomorrow, as per 2 G.A.R., Div. 4, §9101(c)(4).

Thank you!



Si Yu'os Ma'åse,

Camaryn Aguon

Buyer I

GUAM SOLID WASTE AUTHORITY

546 N. Marine Corps Dr., Tamuning, Guam 96913

T: (671) 646-3111 | F: (671) 649-3777

W: www.gswa.guam.gov

2 attachments

GSWA-004-24 Stay of Procurement.pdf
196K

GSWA-004-24 Procurement Protest.pdf
86K

Irvin Slike <irvin.slike@gswa.guam.gov>

27 December 2023 at 23:29

To: GWSA Procurement <procurement@gswa.guam.gov>

We responded or equal correct? the rise and fall of wheels is a measurement...the Case, Volvo, Caterpillar all have wheels that can meet the specification, just not on smaller models. The wheel deflection is imortane to get curb clearance in urban environment or in off road applications.
this loader may be tasked with illegal dump clean-up.

The reversible hydraulic fan was specified again for illegal dump clean-up, dust, paper plastic can clog radiator and you need fan to reverse flow to maintain engine coolant temp. In addition GSWA may be tasked with processing green waste (brush, leaves, branches) and that waste when ground up is extrremely dusty and fine particles can clog radiators.

can be installed after market as well.

[Quoted text hidden]

GSWA Procurement <procurement@gswa.guam.gov>
To: Alicia Fejeran <alicia.fejeran@gswa.guam.gov>

28 December 2023 at 08:51

FYI.

[Quoted text hidden]

**IFB No. GSWA-004-24: Compact Wheel Loader w/ Attachments**

1 message

GSWA Procurement <procurement@gswa.guam.gov>

27 December 2023 at 16:12

To: Jimmy Cruz <JPCRUZ@hawthornecat.com>

Cc: Alicia Fejeran <alicia.fejeran@gswa.guam.gov>, Keilani Mesa <keilani.mesa@gswa.guam.gov>, Irvin Slike <irvin.slike@gswa.guam.gov>

Håfa Adai!

Please see attached Notice re: Stay of Procurement for your reference. Please sign the acknowledgement portion on the bottom of the page & send back at your earliest convenience.

Thank you!

*Si Yu'os Ma'åse,***Camaryn Aguon***Buyer I***GUAM SOLID WASTE AUTHORITY**

546 N. Marine Corps Dr., Tamuning, Guam 96913

T: (671) 646-3111 | F: (671) 649-3777

W: www.gswa.guam.gov **GSWA-004-24 Notice re Stay of Procurement.pdf**
26K



GWSA Procurement <procurement@gswa.guam.gov>

IFB No. GSWA-004-24: Compact Wheel Loader w/ Attachments

1 message

GWSA Procurement <procurement@gswa.guam.gov>

27 December 2023 at 16:12

To: John Limtiaco <jlimtiaco@fareastequipment.com>, Ryne Santos <rsantos@fareastequipment.com>

Cc: Alicia Fejeran <alicia.fejeran@gswa.guam.gov>, Keilani Mesa <keilani.mesa@gswa.guam.gov>, Irvin Slike <irvin.slike@gswa.guam.gov>

Håfa Adai!

Please see attached Notice re: Stay of Procurement for your reference. Please sign the acknowledgement portion on the bottom of the page & send back at your earliest convenience.

Thank you!

*Si Yu'os Ma'åse,***Camaryn Aguon***Buyer I***GUAM SOLID WASTE AUTHORITY**

546 N. Marine Corps Dr., Tamuning, Guam 96913

T: (671) 646-3111 | F: (671) 649-3777

W: www.gswa.guam.gov **GSWA-004-24 Notice re Stay of Procurement.pdf**
26K



GSWA Procurement <procurement@gswa.guam.gov>

IFB No. GSWA-004-24: Compact Wheel Loader w/ Attachments

1 message

GSWA Procurement <procurement@gswa.guam.gov>

27 December 2023 at 16:12

To: USA Contractors Corporation <sales@usacontractorscorp.com>

Cc: Alicia Fejeran <alicia.fejeran@gswa.guam.gov>, Keilani Mesa <keilani.mesa@gswa.guam.gov>, Irvin Slike <irvin.slike@gswa.guam.gov>

Håfa Adai!

Please see attached Notice re: Stay of Procurement for your reference. Please sign the acknowledgement portion on the bottom of the page & send back at your earliest convenience.

Thank you!

*Si Yu'os Ma'åse,***Camaryn Aguon***Buyer I***GUAM SOLID WASTE AUTHORITY**

546 N. Marine Corps Dr., Tamuning, Guam 96913

T: (671) 646-3111 | F: (671) 649-3777

W: www.gswa.guam.gov **GSWA-004-24 Notice re Stay of Procurement.pdf**
26K



IFB No. GSWA-004-24: Compact Wheel Loader w/ Attachments

3 messages

GWSA Procurement <procurement@gswa.guam.gov>

27 December 2023 at 16:12

To: Paul Eustaquio <paul@morricoequipment.com>

Cc: Alicia Fejeran <alicia.fejeran@gswa.guam.gov>, Keilani Mesa <keilani.mesa@gswa.guam.gov>, Irvin Slike <irvin.slike@gswa.guam.gov>

Håfa Adai!

Please see attached Notice re: Stay of Procurement for your reference. Please sign the acknowledgement portion on the bottom of the page & send back at your earliest convenience.

Thank you!



Si Yu'os Ma'åse,

Camaryn Aguon

Buyer I

GUAM SOLID WASTE AUTHORITY

546 N. Marine Corps Dr., Tamuning, Guam 96913

T: (671) 646-3111 | F: (671) 649-3777

W: www.gswa.guam.gov

GSWA-004-24 Notice re Stay of Procurement.pdf
26K

Paul Eustaquio <paul@morricoequipment.com>

28 December 2023 at 08:06

To: GSWA Procurement <procurement@gswa.guam.gov>

Cc: Alicia Fejeran <alicia.fejeran@gswa.guam.gov>, Keilani Mesa <keilani.mesa@gswa.guam.gov>, Irvin Slike <irvin.slike@gswa.guam.gov>

Good Morning Camaryn,

Please see attached acknowledgement for GSWA-004-24 Notice of Stay of Procurement.

Regards,

Paul Eustaquio

Heavy Equipment Sales
671.483.0180



197 Ypao Road, Tamuning Guam 96913
671.649.1946
morrigoequipment.com



This message and any attachments are intended only for the use of the addressee and may contain information that is privileged and confidential.

If the reader of the message is not the intended recipient or an authorized representative of the intended recipient, you are hereby notified

that any dissemination of this communication is strictly prohibited. If you have received this communication in error, please notify us immediately

by e-mail and delete the message and any attachments from your system.

From: GSWA Procurement <procurement@gswa.guam.gov>
Sent: Wednesday, December 27, 2023 4:13 PM
To: Paul Eustaquio <paul@morrigoequipment.com>
Cc: Alicia Fejeran <alicia.fejeran@gswa.guam.gov>; Keilani Mesa <keilani.mesa@gswa.guam.gov>; Irvin Slike <irvin.slike@gswa.guam.gov>
Subject: IFB No. GSWA-004-24: Compact Wheel Loader w/ Attachments

[Quoted text hidden]

Acknowledgement GSWA-004-24 Notice re Stay of Procurement.pdf
25K

GSWA Procurement <procurement@gswa.guam.gov> 28 December 2023 at 09:28
To: Paul Eustaquio <paul@morrigoequipment.com>
Cc: Alicia Fejeran <alicia.fejeran@gswa.guam.gov>, Keilani Mesa <keilani.mesa@gswa.guam.gov>, Irvin Slike <irvin.slike@gswa.guam.gov>

Received, thank you!

Best Regards,
Camaryn

[Quoted text hidden]

IFB No. GSWA-004-24: Compact Wheel Loader w/ Attachments

1 message

GSWA Procurement <procurement@gswa.guam.gov>

27 December 2023 at 16:14

To: "Mark S. Cruz" <mcruz@midpacfareast.com>

Cc: Alicia Fejeran <alicia.fejeran@gswa.guam.gov>, Keilani Mesa <keilani.mesa@gswa.guam.gov>, Irvin Slike <irvin.slike@gswa.guam.gov>

Håfa Adai!

Please see attached Notice re: Stay of Procurement for your reference. Please sign the acknowledgement portion on the bottom of the page & send back at your earliest convenience.

Thank you!

*Si Yu'os Ma'åse,***Camaryn Aguon***Buyer I***GUAM SOLID WASTE AUTHORITY**

546 N. Marine Corps Dr., Tamuning, Guam 96913

T: (671) 646-3111 | F: (671) 649-3777

W: www.gswa.guam.gov **GSWA-004-24 Notice re Stay of Procurement.pdf**
26K



GWSA Procurement <procurement@gswa.guam.gov>

IFB No. GSWA-004-24: Compact Wheel Loader w/ Attachments

John Limtiaco <jlimtiaco@fareastequipment.com>

28 December 2023 at 18:49

To: GSWA Procurement <procurement@gswa.guam.gov>

Cc: Ryne Santos <rsantos@fareastequipment.com>, Alicia Fejeran <alicia.fejeran@gswa.guam.gov>, Keilani Mesa <keilani.mesa@gswa.guam.gov>, Irvin Slike <irvin.slike@gswa.guam.gov>

Dear GSWA Procurement,

Far East Equipment would like to state for the record that the products we offered are not all supplied by John Deere and several products had to be sourced by other suppliers and custom made to meet the GSWA bid specifications. Moricco's suggestion that GSWA has to accept the minimum or base specification that Case or its other suppliers has to offer is nonsense. Moricco had the opportunity just like Far East Equipment to find suppliers who would custom make the attachments per the GSWA requirement and not deviate from the requested specifications.

Morocco also had the opportunity to request and have their deviations approved by GSWA which they did not. Moricco should not be allowed to offer whatever they have and expect it to be acceptable simply because they cost less. Allowing this would prejudice Far East from their effort to meet the specification requested by GSWA without deviation.

Sincerely,

John A. Limtiaco

President

Corporate Office: 671-473-4374

DID: 671-473-7378

M: 671-888-6270



[Quoted text hidden]

FILE



Alicia Fejeran <alicia.fejeran@gswa.guam.gov>

Small Wheeled loader protest

Alicia Fejeran <alicia.fejeran@gswa.guam.gov>
To: Irvin Slike <irvin.slike@gswa.guam.gov>
Cc: "Andrew M. Gayle" <agayle@gta.net>

25 January 2024 at 14:26

We haven't heard back. I sent an email to Assistant AG David Rivera who told me that we would need to write a letter of request to the AG.

Delivered the letter of request hard copy to the OAG on January 2nd, and also emailed a copy to Attorney Botha on January 4th.

On Thu, Jan 25, 2024, 1:49 PM Irvin Slike <irvin.slike@gswa.guam.gov> wrote:

Has there been any progress on this protest? Should I send another email to AG's office?

Irv

FILE



GUAM SOLID WASTE AUTHORITY

LOURDES A. LEON GUERRERO
Governor of Guam

JOSHUA F. TENORIO
Lt. Governor of Guam

IRVIN L. SLIKE
General Manager

April 5, 2024

VIA HAND DELIVERY

Kevin J. Fowler, Esq.
Robert Fowler & Visosky, LLP
865 South Marine Corps Drive, Suite 201
Tamuning, Guam 96913

ROBERTS FOWLER & VISOSKY LLP
Date: April 5, 2024
Time: 10:45
Sign: N. Erickson

**Re: Protest by Morrico Equipment LLC to GSWA Invitation to Bid
No. GSWA-004-24 for Compact Wheel Loader with Attachments**

Dear Mr. Fowler:

This is in response to your letter dated December 27, 2023, protesting the procurement of a Compact Wheel Loader published in IFB GSWA-004-24. The protest alleges that (1) Morrico's bid was rejected due to "non-conformance with the specifications" without advising which specification Morrico failed to meet and (2) GSWA restrictively applied the specifications of a particular manufacturer's product.

For the reasons set forth below, GSWA denies Morrico's protest.

Morrigo's protest is untimely.

Morrigo submitted its protest after the statutory deadline. Guam's procurement law requires a written protest be submitted within fourteen (14) days after the aggrieved bidder knows or should have known the facts giving rise to the protest. 5 GCA § 5425.

On November 14, 2023, GSWA informed all bidders, including Morrico, that the John Deere model 244P was the make/model machine GSWA used to form the basis for some IFB specifications. Morrico did not submit its written protest until Jan 2, 2024, more than 14 days from the date it was made aware that GSWA cited John Deere model 244P as its source for some of the IFB's specifications. Therefore, Morrico's protest is untimely and denied.

GSWA's IFB did not solicit a brand name product and was not unduly restrictive.

Even though Morrico's protest is denied for being untimely, GSWA also denies Morrico's allegation that the IFB solicited a brand name product. First, the IFB did not use any brand

Kevin J. Fowler, Esq.
Morrigo Protest of IFB GSWA-004-24



GUAM SOLID WASTE AUTHORITY

LOURDES A. LEON GUERRERO
Governor of Guam

JOSHUA F. TENORIO
Lt. Governor of Guam

IRVIN L. SLIKE
General Manager



names in the specifications. Furthermore, as noted in your protest, the IFB provided that any reference to a manufacturer's brand name is intended to be descriptive but not restrictive.

The procurement record shows that GSWA sought a Compact Wheel Loader with horsepower and weight similar to a John Deere 244/P. Other manufacturers such as Case, Ford, and Volvo make units of similar size that perform similarly.

Furthermore, GSWA developed these specifications to meet the agency's needs in the best interests of Guam. The rise and fall of wheels is a measurement spec that other manufacturers such as Case, Volvo, and Caterpillar can meet. The wheel deflection is needed to get curb clearance in Guam's terrain. Based on experience, the type of waste GSWA would handle to clean up illegal dump sites and green waste such as dust, paper, and plastic can clog a radiator. Green waste such as brush, leaves, and branches is extremely dusty when ground up, and fine particles can clog radiators. Therefore, the specifications also requested a loader with a reversible hydraulic fan to reverse flow to maintain engine coolant temperature. Again, there are several manufacturers that offer products that could have met the IFB specifications.

The specifications are not restrictive and seek a machine that meets GSWA's needs. The specifications do not refer to a brand name and can be met by different vendors. Therefore, the IFB did not restrictively procure a specific manufacturer's product and would deny the protest on that basis too.

Morrico's bid failed to meet the IFB requirements.

Instead of submitting a bid that met the IFB specifications, Morrico submitted a bid that included several "deviations". An IFB is awarded "to the lowest responsible and responsive bidder" whose bid meets the requirements and criteria set forth in the IFB. 5 GCA § 5211(g) and 2 GAR Div 4 § 3109(n)(1). A responsive bidder is a bid that conforms in all material respects to the IFB. 5 GCA § 5201(g) and 2 GAR Div 4 § 3109(n)(2). Any offer that does not meet the acceptability requirements must be rejected as nonresponsive. 2 GAR Div 4 §§ 3109(n)(3), 3115(3)(3)(A)(ii). Morrico admitted in its bid that the product offered failed to meet the IFB requirements. This resulted in Morrico offering a product smaller than what is needed to perform the necessary functions and unable to perform well in the anticipated environment of use. Because Morrico's bid failed to meet the IFB's requirements, GSWA appropriately rejected the bid as nonresponsive.

Morrigo did not request a reason for rejection, but Morrico also submitted a bid that it conceded failed to meet the specifications. Morrico knew or should have known that its failure to offer a product that met the IFB specifications was grounds for rejection.

Kevin J. Fowler, Esq.
Morrigo Protest of IFB GSWA-004-24
Page 4



GUAM SOLID WASTE AUTHORITY



LOURDES A. LEON GUERRERO
Governor of Guam

JOSHUA F. TENORIO
Governor of Guam

IRVIN L. SILKE
General Manager

Conclusion.

GSWA denies Morrico's protest for untimeliness but also denies Morrico's claim that the IFB improperly used a brand name in favor of a particular vendor. Morrico has the right to administrative and judicial review of this decision, denying the protest.

IRVIN L. SILKE
General Manager



GSWA Procurement <procurement@gswa.guam.gov>

GSWA-004-24: Compact Wheel Loader w/ Attachments

1 message

GSWA Procurement <procurement@gswa.guam.gov>

8 April 2024 at 15:25

To: USA Contractors Corporation <sales@usacontractorscorp.com>

Cc: Alicia Fejeran <alicia.fejeran@gswa.guam.gov>, Keilani Mesa <keilani.mesa@gswa.guam.gov>, Roman Perez <roman.perez@gswa.guam.gov>, Dennis Mendiola <dennis.mendiola@gswa.guam.gov>

Håfa Adai!

Please see attached Notice to All Bidders re: Lift of Stay. Kindly acknowledge receipt of this email.

Thank you!



Si Yu'os Má'ase,

Camaryn A. Aguon*Buyer I***GUAM SOLID WASTE AUTHORITY**

546 N. Marine Corps Dr., Tamuning, Guam 96913

T: (671) 646-3111 | F: (671) 649-3777

W: www.gswa.guam.gov **GSWA-004-24 Notice re Lift of Stay.pdf**
24K

FILE



GSWA Procurement <procurement@gswa.guam.gov>

GSWA-004-24: Compact Wheel Loader w/ Attachments

1 message

GSWA Procurement <procurement@gswa.guam.gov>

8 April 2024 at 15:26

To: derrick@guamautospot.com

Cc: Alicia Fejeran <alicia.fejeran@gswa.guam.gov>, Keilani Mesa <keilani.mesa@gswa.guam.gov>, Roman Perez <roman.perez@gswa.guam.gov>, Dennis Mendiola <dennis.mendiola@gswa.guam.gov>

Håfa Adai!

Please see attached Notice to All Bidders re: Lift of Stay. Kindly acknowledge receipt of this email.

Thank you!



Si Yu'os Má'ase,

Camaryn A. Aguon

Buyer I

GUAM SOLID WASTE AUTHORITY

546 N. Marine Corps Dr., Tamuning, Guam 96913

T: (671) 646-3111 | F: (671) 649-3777

W: www.gswa.guam.gov

GSWA-004-24 Notice re Lift of Stay.pdf
24K

**FILE****GSWA-004-24: Compact Wheel Loader w/ Attachments**

1 message

GSWA Procurement <procurement@gswa.guam.gov>

8 April 2024 at 15:26

To: Paul Eustaquio <paul@morricoequipment.com>, Jesse Munoz <jesse.munoz@morricoequipment.com>

Cc: Alicia Fejeran <alicia.fejeran@gswa.guam.gov>, Keilani Mesa <keilani.mesa@gswa.guam.gov>, Dennis Mendiola <dennis.mendiola@gswa.guam.gov>, Roman Perez <roman.perez@gswa.guam.gov>

Håfa Adai!

Please see attached Notice to All Bidders re: Lift of Stay. Kindly acknowledge receipt of this email.

Thank you!



Si Yu'os Má'ase,

Camaryn A. Aguon*Buyer I***GUAM SOLID WASTE AUTHORITY**

546 N. Marine Corps Dr., Tamuning, Guam 96913

T: (671) 646-3111 | F: (671) 649-3777

W: www.gswa.guam.gov **GSWA-004-24 Notice re Lift of Stay.pdf**
24K



GSWA Procurement <procurement@gswa.guam.gov>

FILE

GSWA-004-24: Compact Wheel Loader w/ Attachments

1 message

GSWA Procurement <procurement@gswa.guam.gov>

8 April 2024 at 15:26

To: "Mark S. Cruz" <mcruz@midpacfareast.com>, Chris Camacho <ccamacho@midpacfareast.com>

Cc: Alicia Fejeran <alicia.fejeran@gswa.guam.gov>, Keilani Mesa <keilani.mesa@gswa.guam.gov>, Roman Perez <roman.perez@gswa.guam.gov>, Dennis Mendiola <dennis.mendiola@gswa.guam.gov>

Håfa Adai!

Please see attached Notice to All Bidders re: Lift of Stay. Kindly acknowledge receipt of this email.

Thank you!

Si Yu'os Má'ase,

Camaryn A. Aguon

Buyer I

GUAM SOLID WASTE AUTHORITY

546 N. Marine Corps Dr., Tamuning, Guam 96913

T: (671) 646-3111 | F: (671) 649-3777

W: www.gswa.guam.gov



GSWA-004-24 Notice re Lift of Stay.pdf
24K



GSWA Procurement <procurement@gswa.guam.gov>

GSWA-004-24: Compact Wheel Loader w/ Attachments

1 message

GSWA Procurement <procurement@gswa.guam.gov>

8 April 2024 at 15:26

To: Jimmy Cruz <JPCRUZ@hawthornecat.com>, Jan Lee Arceo-Guerrero <jguerrero@hawthornecat.com>

Cc: Alicia Fejeran <alicia.fejeran@gswa.guam.gov>, Keilani Mesa <keilani.mesa@gswa.guam.gov>, Roman Perez <roman.perez@gswa.guam.gov>, Dennis Mendiola <dennis.mendiola@gswa.guam.gov>

Håfa Adai!

Please see attached Notice to All Bidders re: Lift of Stay. Kindly acknowledge receipt of this email.

Thank you!



Si Yu'os Má'ase,

Camaryn A. Aguon

Buyer I

GUAM SOLID WASTE AUTHORITY

546 N. Marine Corps Dr., Tamuning, Guam 96913

T: (671) 646-3111 | F: (671) 649-3777

W: www.gswa.guam.gov

GSWA-004-24 Notice re Lift of Stay.pdf
24K



GWSA Procurement <procurement@gswa.guam.gov>

GWSA-004-24: Compact Wheel Loader w/ Attachments

3 messages

GWSA Procurement <procurement@gswa.guam.gov>

8 April 2024 at 15:26

To: John Limtiaco <jlimtiaco@fareastequipment.com>, Ryne Santos <rsantos@fareastequipment.com>

Cc: Alicia Fejeran <alicia.fejeran@gswa.guam.gov>, Keilani Mesa <keilani.mesa@gswa.guam.gov>, Roman Perez <roman.perez@gswa.guam.gov>, Dennis Mendiola <dennis.mendiola@gswa.guam.gov>

Håfa Adai!

Please see attached Notice to All Bidders re: Lift of Stay. Kindly acknowledge receipt of this email.

Thank you!



Si Yu'os Må'ase,

Camaryn A. Aguon*Buyer I***GUAM SOLID WASTE AUTHORITY**

546 N. Marine Corps Dr., Tamuning, Guam 96913

T: (671) 646-3111 | F: (671) 649-3777

W: www.gswa.guam.gov **GWSA-004-24 Notice re Lift of Stay.pdf**
24K**John Limtiaco** <jlimtiaco@fareastequipment.com>

8 April 2024 at 19:41

To: GWSA Procurement <procurement@gswa.guam.gov>

Cc: Ryne Santos <rsantos@fareastequipment.com>, Alicia Fejeran <alicia.fejeran@gswa.guam.gov>, Keilani Mesa <keilani.mesa@gswa.guam.gov>, Roman Perez <roman.perez@gswa.guam.gov>, Dennis Mendiola <dennis.mendiola@gswa.guam.gov>, Marisa Reyes <mreyes@fareastequipment.com>

Hafa Adai Camaryn,

Acknowledged receipt of your email and will sign and send back acknowledgment on the form.

Regards,

John A. Limtiaco

President

Corporate Office: 671-473-4374

DID: 671-473-7378

M: 671-888-6270



GSWA Procurement <procurement@gswa.guam.gov>

9 April 2024 at 08:11

To: John Limtiaco <jlimtiaco@fareastequipment.com>

Cc: Ryne Santos <rsantos@fareastequipment.com>, Alicia Fejeran <alicia.fejeran@gswa.guam.gov>, Keilani Mesa <keilani.mesa@gswa.guam.gov>, Roman Perez <roman.perez@gswa.guam.gov>, Dennis Mendiola <dennis.mendiola@gswa.guam.gov>, Marisa Reyes <mreyes@fareastequipment.com>

Thank you!

Best Regards,
Camaryn

[Quoted text hidden]

**GSWA-004-24: Compact Wheel Loader w/ Attachments**

3 messages

GSWA Procurement <procurement@gswa.guam.gov>

8 April 2024 at 17:04

To: John Limtiaco <jlimtiaco@fareastequipment.com>

Cc: Alicia Fejeran <alicia.fejeran@gswa.guam.gov>, Keilani Mesa <keilani.mesa@gswa.guam.gov>

Hafa Adai, Mr. Limtiaco!

GSWA would like to schedule a day for contract signing of the above-mentioned IFB. Please let me know what date & time works best for you.

Thank you!



Si Yu'os Ma'ase,

Camaryn A. Aguon*Buyer I***GUAM SOLID WASTE AUTHORITY**

546 N. Marine Corps Dr., Tamuning, Guam 96913

T: (671) 646-3111 | F: (671) 649-3777

W: www.gswa.guam.gov**John Limtiaco** <jlimtiaco@fareastequipment.com>

8 April 2024 at 19:43

To: GSWA Procurement <procurement@gswa.guam.gov>

Cc: Alicia Fejeran <alicia.fejeran@gswa.guam.gov>, Keilani Mesa <keilani.mesa@gswa.guam.gov>, Ryne Santos <rsantos@fareastequipment.com>, Marisa Reyes <mreyes@fareastequipment.com>

Hafa Adai Camaryn,

We would need to confirm with factory if pricing is still valid as this has been on stay for quite a while. Please give me a couple of days to confirm the pricing from the different suppliers.

Regards,

John A. Limtiaco

President

Corporate Office: 671-473-4374

DID: 671-473-7378

M: 671-888-6270



[Quoted text hidden]

GSWA Procurement <procurement@gswa.guam.gov>

9 April 2024 at 08:12



<rsantos@fareastequipment.com>, Marisa Reyes <mreyes@fareastequipment.com>

Sounds good, thank you!

Best Regards,
Camaryn

[Quoted text hidden]



GUAM SOLID WASTE AUTHORITY

LOURDES A. LEON GUERRERO

JOSHUA F. TENORIO

IRVIN SLIKE



April 8, 2024

INVITATION FOR BID GSWA-004-24 COMPACT WHEEL LOADER WITH ATTACHMENTS

NOTICE TO ALL PROSPECTIVE BIDDERS

This is to inform all prospective bidders that the Stay of Procurement for Invitation for Bid GSWA-004-24 has been lifted.

IRVIN L. SLIKE
GENERAL MANAGER

ACKNOWLEDGEMENT RECEIPT	
Return to GSWA by email or fax.	
Received By	<i>Marisa Reyes</i>
Date	<i>4/9/2024</i>
Company Name	<i>Far East Equipment Company, LLC</i>
Fax to: 671-649-3777	
Email: procurement@gswa.guam.gov	



GSWA Procurement <procurement@gswa.guam.gov>

GSWA-004-24: Compact Wheel Loader w/ Attachments

3 messages

GSWA Procurement <procurement@gswa.guam.gov>

8 April 2024 at 15:26

To: John Limtiaco <jlimtiaco@fareastequipment.com>, Ryne Santos <rsantos@fareastequipment.com>

Cc: Alicia Fejeran <alicia.fejeran@gswa.guam.gov>, Keilani Mesa <keilani.mesa@gswa.guam.gov>, Roman Perez <roman.perez@gswa.guam.gov>, Dennis Mendiola <dennis.mendiola@gswa.guam.gov>

Hafa Adai!

Please see attached Notice to All Bidders re: Lift of Stay. Kindly acknowledge receipt of this email.

Thank you!



Si Yu'os Ma'ase,

Camaryn A. Aguon

Buyer I

GUAM SOLID WASTE AUTHORITY

546 N. Marine Corps Dr., Tamuning, Guam 96913

T: (671) 646-3111 | F: (671) 649-3777

W: www.gswa.guam.gov

GSWA-004-24 Notice re Lift of Stay.pdf
24K

John Limtiaco <jlimtiaco@fareastequipment.com>

8 April 2024 at 19:41

To: GSWA Procurement <procurement@gswa.guam.gov>

Cc: Ryne Santos <rsantos@fareastequipment.com>, Alicia Fejeran <alicia.fejeran@gswa.guam.gov>, Keilani Mesa <keilani.mesa@gswa.guam.gov>, Roman Perez <roman.perez@gswa.guam.gov>, Dennis Mendiola <dennis.mendiola@gswa.guam.gov>, Marisa Reyes <mreyes@fareastequipment.com>

Hafa Adai Camaryn,

Acknowledged receipt of your email and will sign and send back acknowledgment on the form.

Regards,

John A. Limtiaco

President

Corporate Office: 671-473-4374

DID: 671-473-7378

M: 671-888-6270



{Quoted text hidden}

GSWA Procurement <procurement@gswa.guam.gov>

9 April 2024 at 08:11

To: John Limtiaco <jlimtiaco@fareastequipment.com>

Cc: Ryne Santos <rsantos@fareastequipment.com>, Alicia Fejeran <alicia.fejeran@gswa.guam.gov>, Keilani Mesa <keilani.mesa@gswa.guam.gov>, Roman Perez <roman.perez@gswa.guam.gov>, Dennis Mendiola <dennis.mendiola@gswa.guam.gov>, Marisa Reyes <mreyes@fareastequipment.com>

Thank you!

Best Regards,
Camaryn

{Quoted text hidden}

<Alicia Fejeran <alicia.fejeran@gswa.guam.gov>, Keilani Mesa <keilani.mesa@gswa.guam.gov>, Ryne Santos <rsantos@fareastequipment.com>, Marisa Reyes <mreyes@fareastequipment.com>

Sounds good, thank you!

Best Regards,
Camaryn

[Quoted text hidden]

John Limtiaco <jlimtiaco@fareastequipment.com>

11 April 2024 at 18:26

To: GSWA Procurement <procurement@gswa.guam.gov>

Cc: Alicia Fejeran <alicia.fejeran@gswa.guam.gov>, Keilani Mesa <keilani.mesa@gswa.guam.gov>, Ryne Santos <rsantos@fareastequipment.com>, Marisa Reyes <mreyes@fareastequipment.com>

Hafa Adai Camaryn,

We have reviewed the bid document and our pricing expired on April 3, 2024. We have also confirmed pricing with our suppliers and although there has been an increase in prices for all the items we are willing to extend our existing pricing and accept this award in good faith. Please advise when you would like me to come down for contract signing. Please note I travel on April 16th and return April 26th so I would like to get this signed prior to my travel schedule.

Sincerely,

John A. Limtiaco

President

Corporate Office: 671-473-4374

DID: 671-473-7378

M: 671-888-6270



[Quoted text hidden]

GSWA Procurement <procurement@gswa.guam.gov>

12 April 2024 at 08:44

To: John Limtiaco <jlimtiaco@fareastequipment.com>

Cc: Alicia Fejeran <alicia.fejeran@gswa.guam.gov>, Keilani Mesa <keilani.mesa@gswa.guam.gov>, Ryne Santos <rsantos@fareastequipment.com>, Marisa Reyes <mreyes@fareastequipment.com>

Hi, John!

You can drop by anytime today or Monday to sign the contract. Please let me know what works best for you.

Thank you!

Best Regards,
Camaryn

[Quoted text hidden]

John Limtiaco <jlimtiaco@fareastequipment.com>

12 April 2024 at 11:39

To: GSWA Procurement <procurement@gswa.guam.gov>

Cc: Alicia Fejeran <alicia.fejeran@gswa.guam.gov>, Keilani Mesa <keilani.mesa@gswa.guam.gov>, Ryne Santos <rsantos@fareastequipment.com>, Marisa Reyes <mreyes@fareastequipment.com>

I'll come by today.

FILE



GSWA Procurement <procurement@gswa.guam.gov>

GSWA-004-24: Compact Wheel Loader w/ Attachments

10 messages

GSWA Procurement <procurement@gswa.guam.gov>

8 April 2024 at 17:04

To: John Limtiaco <jlimtiaco@fareastequipment.com>

Cc: Alicia Fejeran <alicia.fejeran@gswa.guam.gov>, Keilani Mesa <keilani.mesa@gswa.guam.gov>

Hafa Adai, Mr. Limtiaco!

GSWA would like to schedule a day for contract signing of the above-mentioned IFB. Please let me know what date & time works best for you.

Thank you!



Si Yu'os Má'ase,

Camaryn A. Aguon

Buyer I

GUAM SOLID WASTE AUTHORITY

546 N. Marine Corps Dr., Tamuning, Guam 96913

T: (671) 646-3111 | F: (671) 649-3777

W: www.gswa.guam.gov

John Limtiaco <jlimtiaco@fareastequipment.com>

8 April 2024 at 19:43

To: GSWA Procurement <procurement@gswa.guam.gov>

Cc: Alicia Fejeran <alicia.fejeran@gswa.guam.gov>, Keilani Mesa <keilani.mesa@gswa.guam.gov>, Ryne Santos <rsantos@fareastequipment.com>, Marisa Reyes <mreyes@fareastequipment.com>

Hafa Adai Camaryn,

We would need to confirm with factory if pricing is still valid as this has been on stay for quite a while. Please give me a couple of days to confirm the pricing from the different suppliers.

Regards,

John A. Limtiaco

President

Corporate Office: 671-473-4374

DID: 671-473-7378

M: 671-888-6270



[Quoted text hidden]

GSWA Procurement <procurement@gswa.guam.gov>

9 April 2024 at 08:12

[Quoted text hidden]

GSWA Procurement <procurement@gswa.guam.gov>

16 April 2024 at 09:10

To: John Limtiaco <jlimtiaco@fareastequipment.com>

Cc: Ryne Santos <rsantos@fareastequipment.com>, Marisa Reyes <mreyes@fareastequipment.com>

Good morning, John!

Do you have an estimated timeframe of when we will be receiving the Compact Wheel Loader? Please advise.

Thank you!

Best Regards,
Camaryn

[Quoted text hidden]

John Limtiaco <jlimtiaco@fareastequipment.com>

16 April 2024 at 13:31

To: GSWA Procurement <procurement@gswa.guam.gov>

Cc: Ryne Santos <rsantos@fareastequipment.com>, Marisa Reyes <mreyes@fareastequipment.com>

Hafa Adai Camaryn,

We just submitted the order for wheel loader and specialized attachment. We should know in about 30 days the estimated delivery time. Our bid shows 209 days ARO but will do our best to have factories improve this time.

John

[Quoted text hidden]

GSWA Procurement <procurement@gswa.guam.gov>

16 April 2024 at 16:45

To: John Limtiaco <jlimtiaco@fareastequipment.com>

Cc: Ryne Santos <rsantos@fareastequipment.com>, Marisa Reyes <mreyes@fareastequipment.com>

Thank you for the update.

Best Regards,
Camaryn

[Quoted text hidden]

GSWA Procurement <procurement@gswa.guam.gov>

16 April 2024 at 16:45

To: Irvin Slike <irvin.slike@gswa.guam.gov>

FYI.

[Quoted text hidden]

CONTRACT



GSWA PROCUREMENT RECORD Page 389
GUAM SOLID WASTE AUTHORITY

LOURDES A. LEON GUERRERO
 Governor of Guam

JOSHUA F. TENORIO
 Lt. Governor of Guam

IRVIN L. SLIKE
 General Manager



INVITATION FOR BID NO.: GSWA-004-24

DESCRIPTION: COMPACT WHEEL LOADER W/ ATTACHMENTS

SPECIAL REMINDER TO PROSPECTIVE BIDDERS

ORIGINAL

Bidders are reminded to read the Sealed Bid Solicitation and Instructions, and General Terms and Conditions attached to the IFB to ascertain that all of the following requirements checked below are submitted in the bid envelope, in duplicate, and the date and time for bid opening.

- (X) **BID GUARANTEE (15% of Bid Amount) May be in the form of;**
Reference #11 on the General Terms and Conditions
 - a. Cashier's Check or Certified Check
 - b. Letter of Credit
 - c. Surety Bond – Valid only if accompanied by:
 - 1. Current Certificate of Authority issued by the Insurance Commissioner;
 - 2. Power of Attorney issued by the Surety to the Resident General Agent;
 - 3. Power of Attorney issued by two (2) major officers of the Surety to whoever is signing on their behalf.

- (X) **BROCHURES/DESCRIPTIVE LITERATURE;**

- (X) **AFFIDAVIT DISCLOSING OWNERSHIP, INFLUENCE, COMMISSION, & CONFLICT OF INTEREST**
 - a. Date of signature of the person authorize to sign the bid and the notary date must be the same.

- (X) **OTHER REQUIREMENTS:**
Affidavit re Non-Collusion, Affidavit re No Gratuities or Kickbacks, Affidavit re Ethical Standards, Affidavit D.O.L. Wage Determination, Affidavit re Contingent Fees, Special Provision; Restriction Against Sexual Offenders

- (X) **CURRENT BUSINESS LICENSE / CONTRACTOR'S LICENSE / SPECIALTY LICENSE**
IN REFERENCE TO SUPPLIES OR SERVICES FOR THIS BID

This reminder must be signed and returned in the bid envelope together with the bid. Failure to comply with the above requirements may be cause for disqualification and rejection of bid.

On this 14th day of November, 2023, I John Alexius Limtiaco Jr, authorized representative of Far East Equipment Company, LLC acknowledge receipt of this special reminder to prospective bidders with the above referenced IFB.

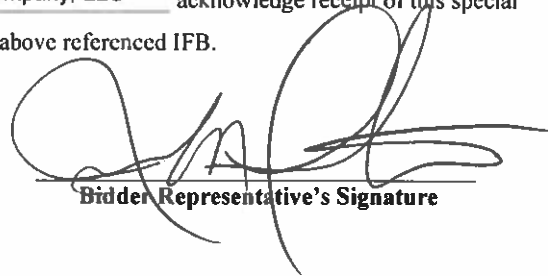
Bidder Representative's Signature



GUAM SOLID WASTE AUTHORITY

LOURDES A. LEON GUERRERO
Governor of Guam

JOSHUA F. TENORIO
Lt. Governor of Guam

IRVIN L. SLIKE
General Manager



INVITATION FOR BID

ISSUING OFFICE:

IRVIN L. SLIKE
General Manager

10/31/23
DATE

GUAM SOLID WASTE AUTHORITY
546 NORTH MARINE CORPS DRIVE
TAMUNING, GUAM 96913

DATE ISSUED: 11/03/2023
BID INVITATION NO.: GSWA-004-24
BID FOR: COMPACT WHEEL LOADER W/ ATTACHMENTS
SPECIFICATION: SEE ATTACHED
DESTINATION: GUAM SOLID WASTE AUTHORITY
REQUIRED DELIVERY DATE: 200 DAYS UPON RECEIPT OF PURCHASE ORDER

INSTRUCTIONS TO BIDDERS:

INDICATE WHETHER: INDIVIDUAL PARTNERSHIP CORPORATION
INCORPORATED IN: Guam

This bid shall be submitted in duplicate and sealed to the issuing office no later than (Time) **1:00PM**,
Date: **11/20/2023**, and shall be publicly opened. Bid submitted after the time and date specified above shall be rejected.
See attached General Terms and Conditions and Sealed Bid Solicitation for details.

The undersigned offers and agrees to furnish within the time specified, the articles and services at the price stated opposite the respective items listed on the schedule provided, unless otherwise specified by the bidder. In consideration to the expense of the Government in opening, tabulating, and evaluating this and other bids, and other considerations, the undersigned agrees that this bid remain firm and irrevocable within one hundred twenty (120) calendar days from the date opening to supply any or all the items which prices are quoted.

NAME AND ADDRESS OF BIDDER:
Far East Equipment Company, LLC
P.O. Box 10838
Tamuning, GU 96931

SIGNATURE AND TITLE OF PERSON
AUTHORIZED TO SIGN THIS BID:

John Alexis Limtiaco Jr. / President

AWARD: CONTRACT NO.: GSWA-004-24 AMOUNT: \$227,261.18 DATE: 04/12/2024

ITEM NO(S). AWARDED: COMPACT WHEEL LOADER W/ ATTACHMENTS

CONTRACTING OFFICER:

IRVIN L. SLIKE
General Manager

4/12/24
DATE

NAME AND ADDRESS OF CONTRACTOR:

SIGNATURE AND TITLE OF PERSON
AUTHORIZED TO SIGN THIS CONTRACT:

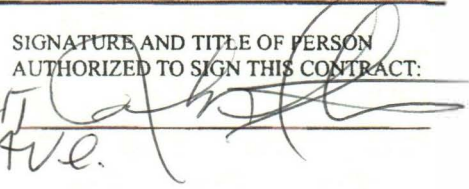
FAREASTEQUIPMENT
17-3311 CORSAIR AVE.
Barrigada, GUAM
96913



**AFFIDAVIT DISCLOSING OWNERSHIP, INFLUENCE, COMMISSIONS AND
CONFLICTS OF INTEREST**

(Required by 5 GCA § 5233 as amended by P.L. 36-13 (4/9/2021))

CITY OF Hagatna)
) ss.
 ISLAND OF GUAM)

Preface. As a condition of submitting a Bid/Offer/Proposal or responding to any method of source selection under Guam’s Procurement Law for the purpose of entering into a contract with the government of Guam, this Affidavit requires all Bidders/Offerors/Prospective Contractors to make disclosures of ownership, influence, commissions, gratuities, kickbacks, and conflicts of interest occurring **during the 365 calendar days preceding the publication of this solicitation and until award of a contract**. This includes the duty to disclose **any changes** to the facts disclosed herein throughout the solicitation process; and if the entity submitting this Affidavit is awarded a contract, the duty to disclose **any changes** to the facts disclosed herein **continues throughout the life of the contract, including any extensions or renewals**.

A. I, the undersigned, being first duly sworn, depose and say that I am an authorized representative of the Bidder/Offeror/Prospective Contractor and that (please check and fill out all that apply):

The Bidder/Offeror/Prospective Contractor is an individual with a business license, and all decisions are by, and all profit is for, that same individual, with principal place of business street address being: _____

The Bidder/Offeror/Prospective Contractor is a business or artificial person (as defined in 1 GCA § 715 or 5 GCA §§ 5030(n) or 5233(b)), and is a sole proprietorship owned entirely (100%) by _____, with principal place of business street address being: _____

The Bidder/Offeror/Prospective Contractor is a business or artificial person (as defined in 1 GCA § 715 or 5 GCA §§ 5030(n) or 5233(b)), and is owned by the following multiple individuals. Note: owners of more than 10% are statutorily required to be listed below, but other owners of smaller percentage are encouraged to be listed as well.

Name of Owner	Principal Place of Business Street Address	% of Interest
<u>Pacific Unlimited Inc.</u>	<u>P.O. Box 10838 Tamuning, GU 96931</u>	<u>100%</u>
_____	_____	_____
_____	_____	_____
_____	_____	_____

Affidavit Disclosing Ownership, Influence,
Commissions and Conflicts of Interest
AG Procurement Form 002 (Rev. 11/17/2021)

One or more of the more-than-10% owners listed above is a business or artificial person. Any more-than-25% owners of such a business or artificial person are listed below per 5 GCA § 5233. Note: any less-than-25% owners of such a business or artificial person is encouraged to also be listed below.

Name of >10% Owner Business or Artificial Person:

Pacific Unlimited Inc.	100%
------------------------	------

Names of owners of the >10% Owner Business or Artificial Person ("Second Tier Owner")	Owner's Principal Place of Business Street Address	% of Interest
John A. Limtiaco	P.O. Box 10838 Tamuning, GU 96931	52%
Lawrence V. Limtiaco	P.O. Box 10838 Tamuning, GU 96931	22.5%
Selita L. Limtiaco	P.O. Box 10838 Tamuning, GU 96931	15.5%
Michael T. Limtiaco	P.O. Box 10838 Tamuning, GU 96931	10%

Name of other >10% Owner Business or Artificial Person:

--

Names of owners of the >10% Owner Business or Artificial Person ("Second Tier Owner")	Owner's Principal Place of Business Street Address	% of Interest

B. If any Second Tier Owner identified above is an artificial person, the natural or artificial owners of such Second Tier Owner who have held more than 49% of the shares or interest in the Bidder/Offeror/Prospective Contractor (Third Tier Owners) are as follows [if none, please so state]:

Second Tier Owner Name _____

Name of Third Tier Owner	Principal Place of Business Street Address	% of Interest
_____	_____	_____
_____	_____	_____
_____	_____	_____
_____	_____	_____

Affidavit Disclosing Ownership, Influence,
Commissions and Conflicts of Interest
AG Procurement Form 002 (Rev. 11/17/2021)

- C. If the name of no natural person has been identified as an owner, or a Second or Third Tier Owner of the Bidder/Offeror/Prospective Contractor, please identify the name, position, address, and contact information of the natural person having the authority and responsibility for the Bid/Offer/Proposal/Prospective Contract, and the name of any natural person who has the authority and power to remove and replace the designated responsible person:

Name of Natural Person	Position	Street Address of Principal Place of Business	Phone Number, Email Address, and other Contact Information
John Alexius Limtiaco Jr.	President	P.O. Box 10838 Tamuning, GU 96931	671-888-6270

- D. Further, I say that the persons who have received or are entitled to receive a commission, gratuity, contingent fee or other compensation to solicit, secure, or assist in obtaining business related to the Bid/Offer/Proposal/Prospective Contract for which this Affidavit is submitted are as follows (if none, please so state):

Name	Principal Place of Business Street Address	Amount of Compensation
N/A	N/A	N/A

- E. Further, I say that the persons who have directly or indirectly participated in this solicitation and who are also employees of the government of Guam or the government of the United States, if federal funds are to be used in the payment of the contract related to the Bid/Offer/Proposal/Prospective Contract for which this Affidavit is submitted, are as follows (if none, please so state):

Name	Principal Place of Business Street Address
N/A	N/A

- F. Regardless of any ownership interest, the following individuals have the power to control the performance of the contract or to control the Bidder/Offeror/Prospective Contractor, directly or indirectly:

Name	Principal Place of Business Street Address
N/A	N/A

///
///

Affidavit Disclosing Ownership, Influence,
Commissions and Conflicts of Interest
AG Procurement Form 002 (Rev. 11/17/2021)

G. Until award of the contract, and throughout the term of any contract awarded to the Bidder/Offeror/Prospective Contractor represented herein, I agree to promptly make any disclosures not made previously and update changes in ownership, identities of owners and other required information, interests, compensation or conflicts of the persons required to be disclosed. I understand that failure to comply with this requirement shall constitute a material breach of contract.

H. I hereby declare under penalty of perjury under the laws of Guam that the foregoing is true and correct.

Executed on: 11-17-2023
(date)

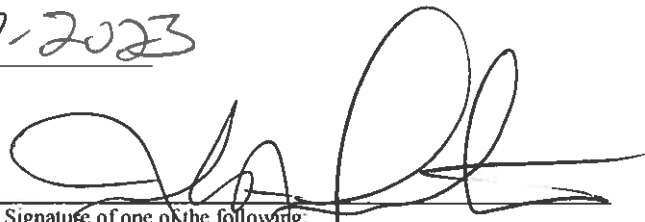

Signature of one of the following:
Bidder/Offeror/Prospective Contractor, if a licensed individual
Owner of sole proprietorship Bidder/Offeror/Prospective
Contractor
Partner, if the Bidder/Offeror/Prospective Contractor is a
partnership
Officer, if the Bidder/Offeror/Prospective Contractor is a
corporation

Subscribed and sworn to before me

This 17th day of November, 20 23.



NOTARY PUBLIC

My commission expires: November 3, 2025

RENEE ANN C. WADE
NOTARY PUBLIC
In and for the Territory of Guam, U.S.A.
My Commission Expires: **NOV. 03, 2025**
111 Chalan Santo Papa Hagåtña, Guam 96910



AFFIDAVIT RE NON-COLLUSION

CITY OF Hagatna)
) SS.
ISLAND OF GUAM)

John Alexius Lirtiaco Jr. [state name of affiant signing below], being first duly sworn, deposes and says that:

1. The name of the offering company or individual is [state name of company] Far East Equipment Company, LLC

2. The proposal for the solicitation identified above is genuine and not collusive or a sham. The offeror has not colluded, conspired, connived or agreed, directly or indirectly, with any other offeror or person, to put in a sham proposal or to refrain from making an offer. The offeror has not in any manner, directly or indirectly, sought by an agreement or collusion, or communication or conference, with any person to fix the proposal price of offeror or of any other offeror, or to fix any overhead, profit or cost element of said proposal price, or of that of any other offeror, or to secure any advantage against the government of Guam or any other offeror, or to secure any advantage against the government of Guam or any person interested in the proposed contract. All statements in this affidavit and in the proposal are true to the best of the knowledge of the undersigned. This statement is made pursuant to 2 GAR Division 4 § 3126(b).

3. I make this statement on behalf of myself as a representative of the offeror, and on behalf of the offeror's officers, representatives, agents, subcontractors, and employees.

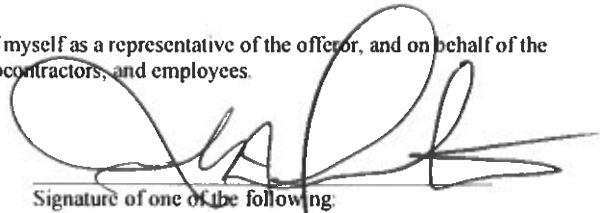

Signature of one of the following:

- Offeror, if the offeror is an individual,
- Partner, if the offeror is a partnership,
- Officer, if the offeror is a corporation.

Subscribed and sworn to before me

this 17th day of November, 2023

NOTARY PUBLIC
My commission expires November 3, 2025

RENEE ANN C. WADE
NOTARY PUBLIC
In and for the Territory of Guam, U.S.A.
My Commission Expires: **NOV. 03, 2025**
111 Chalan Santo Papa Hagåtña, Guam 96910

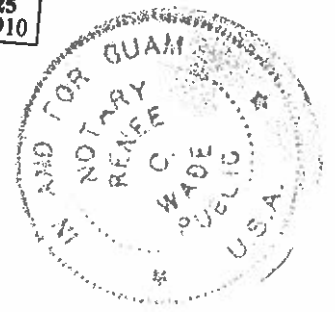

AFFIDAVIT re NO GRATUITIES or KICKBACKS

CITY OF Hagatna)
) ss.
ISLAND OF GUAM)

John Alexius Limtiaco Jr. [state name of affiant signing below], being first duly sworn, deposes and says that:

1. The name of the offering firm or individual is [state name of offeror company] Far East Equipment Company, LLC. Affiant is President [state one of the following: the offeror, a partner of the offeror, an officer of the offeror] making the foregoing identified bid or proposal.

2. To the best of affiant's knowledge, neither affiant, nor any of the offeror's officers, representatives, agents, subcontractors, or employees have violated, are violating the prohibition against gratuities and kickbacks set forth in 2 GAR Division 4 § 11107(e). Further, affiant promises, on behalf of offeror, not to violate the prohibition against gratuities and kickbacks as set forth in 2 GAR Division 4 § 11107(e).

3. To the best of affiant's knowledge, neither affiant, nor any of the offeror's officers, representatives, agents, subcontractors, or employees have offered, given or agreed to give, any government of Guam employee or former government employee, any payment, gift, kickback, gratuity or offer of employment in connection with the offeror's proposal.

4. I make these statements on behalf of myself as a representative of the offeror, and on behalf of the offeror's officers, representatives, agents, subcontractors, and employees.

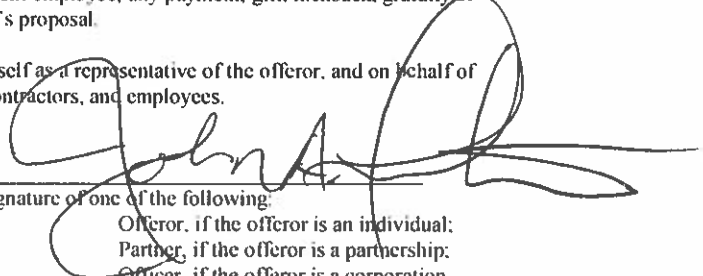

Signature of one of the following:
Offeror, if the offeror is an individual;
Partner, if the offeror is a partnership;
Officer, if the offeror is a corporation.

Subscribed and sworn to before me

this 17th day of November, 2023



NOTARY PUBLIC

My commission expires November 03, 2025.

RENEE ANN C. WADE
NOTARY PUBLIC
In and for the Territory of Guam, U.S.A.
My Commission Expires: **NOV. 03, 2025**
111 Chalan Santo Papa Hagåtña, Guam 96910



AFFIDAVIT RE ETHICAL STANDARDS

CITY OF Hagatna)
) ss.
ISLAND OF GUAM)

John Alexius Limtiaco Jr. [state name of affiant signing below], being first
duly sworn, deposes and says that:

The affiant is President [state one of the following: the offeror,
a partner of the offeror, an officer of the offeror] making the foregoing identified bid or proposal. To the
best of affiant's knowledge, neither affiant nor any officers, representatives, agents, subcontractors or
employees of offeror have knowingly influenced any government of Guam employee to breach any of the
ethical standards set forth in 5 GCA Chapter 5, Article 11. Further, affiant promises that neither he or
she, nor any officer, representative, agent, subcontractor, or employee of offeror will knowingly
influence any government of Guam employee to breach any ethical standards set forth in 5 GCA Chapter
5, Article 11. These statements are made pursuant to 2 GAR Division 4 § 11103(b).

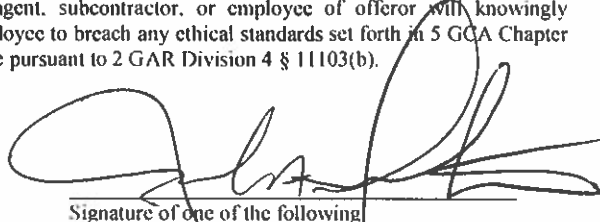

Signature of one of the following
Offeror, if the offeror is an individual;
Partner, if the offeror is a partnership;
Officer, if the offeror is a corporation.

Subscribed and sworn to before me ^R
this 17th day of November, 2023

NOTARY PUBLIC
My commission expires November 03, 2025

RENEE ANN C. WADE
NOTARY PUBLIC
In and for the Territory of Guam, U.S.A.
My Commission Expires: **NOV. 03, 2025**
111 Chalan Santo Papa Hagatna, Guam 96910



DECLARATION RE COMPLIANCE WITH U.S. DOI WAGE DETERMINATION

Procurement No.: GSWA-004-24

Name of Offeror Company Far East Equipment Company, LLC

I, John Alexius Limtiaco Jr. hereby certify under penalty of perjury:

(1) That I am President [please select one: the offeror, a partner of the offeror, an officer of the offeror] making the bid or proposal in the foregoing identified procurement;

(2) That I have read and understand the provisions of 5 GCA § 5801 and § 5802 which read:

§ 5801. Wage Determination Established.

In such cases where the government of Guam enters into contractual arrangements with a sole proprietorship, a partnership or a corporation ("contractor") for the provision of a service to the government of Guam, and in such cases where the contractor employs a person(s) whose purpose, in whole or in part, is the direct delivery of service contracted by the government of Guam, then the contractor shall pay such employee(s) in accordance with the Wage Determination for Guam and the Northern Mariana Islands issued and promulgated by the U.S. Department of Labor for such labor as is employed in the direct delivery of contract deliverables to the government of Guam.

The Wage Determination most recently issued by the U.S. Department of Labor at the time a contract is awarded to a contractor by the government of Guam shall be used to determine wages, which shall be paid to employees pursuant to this Article. Should any contract contain a renewal clause, then at the time of renewal adjustments, there shall be made stipulations contained in that contract for applying the Wage Determination, as required by this Article, so that the Wage Determination promulgated by the U.S. Department of Labor on a date most recent to the renewal date shall apply.

§ 5802. Benefits.

In addition to the Wage Determination detailed in this Article, any contract to which this Article applies shall also contain provisions mandating health and similar benefits for employees covered by this Article, such benefits having a minimum value as detailed in the Wage Determination issued and promulgated by the U.S. Department of Labor, and shall contain provisions guaranteeing a minimum of ten (10) paid holidays per annum per employee.

(3) That the offeror is in full compliance with 5 GCA § 5801 and § 5802, as may be applicable to the procurement referenced herein.

(4) That I have attached the most recent wage determination applicable to Guam issued by the U.S. Department of Labor. [INSTRUCTIONS - Please attach!]

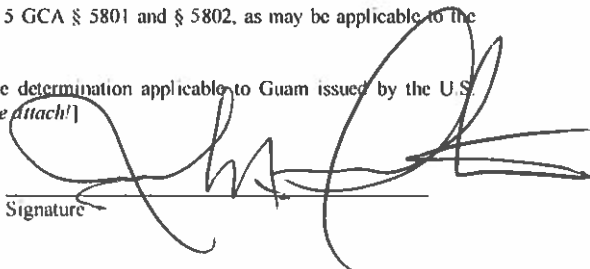
Signature

GSWA PROCUREMENT RECORD Page 399

"REGISTER OF WAGE DETERMINATIONS UNDER THE SERVICE CONTRACT ACT By direction of the Secretary of Labor	U.S. DEPARTMENT OF LABOR EMPLOYMENT STANDARDS ADMINISTRATION WAGE AND HOUR DIVISION WASHINGTON D.C. 20210
--	--

Daniel W. Simms Director	Division of Wage Determinations	Wage Determination No.: 2015-5693 Revision No.: 19 Date Of Last Revision: 07/17/2023
-----------------------------	------------------------------------	--

Note: Contracts subject to the Service Contract Act are generally required to pay at least the applicable minimum wage rate required under Executive Order 14026.

If the contract is entered into on or after January 30, 2022, or the contract is renewed or extended (e.g., an option is exercised) on or after January 30, 2022:	Executive Order 14026 generally applies to the contract. The contractor must pay all covered workers at least \$16.20 per hour (or the applicable wage rate listed on this wage determination, if it is higher) for all hours spent performing on the contract in 2023.
---	--

The applicable Executive Order minimum wage rate will be adjusted annually. Additional information on contractor requirements and worker protections under the Executive Orders is available at www.dol.gov/whd/govcontracts.

States: Guam, Northern Marianas, Wake Island

Area: Guam Statewide
 Northern Marianas Statewide
 Wake Island Statewide

****Fringe Benefits Required Follow the Occupational Listing****

OCCUPATION CODE - TITLE	FOOTNOTE	RATE
01000 - Administrative Support And Clerical Occupations		
01011 - Accounting Clerk I		14.27***
01012 - Accounting Clerk II		16.02***
01013 - Accounting Clerk III		17.93
01020 - Administrative Assistant		21.43
01035 - Court Reporter		17.40
01041 - Customer Service Representative I		12.75***
01042 - Customer Service Representative II		14.23***
01043 - Customer Service Representative III		15.62***
01051 - Data Entry Operator I		12.16***
01052 - Data Entry Operator II		13.27***
01060 - Dispatcher, Motor Vehicle		17.39
01070 - Document Preparation Clerk		13.85***
01090 - Duplicating Machine Operator		13.85***
01111 - General Clerk I		11.33***
01112 - General Clerk II		12.36***
01113 - General Clerk III		13.88***
01120 - Housing Referral Assistant		19.39
01141 - Messenger Courier		11.37***
01191 - Order Clerk I		12.57***
01192 - Order Clerk II		13.71***
01261 - Personnel Assistant (Employment) I		15.95***
01262 - Personnel Assistant (Employment) II		17.85
01263 - Personnel Assistant (Employment) III		19.89
01270 - Production Control Clerk		22.97
01290 - Rental Clerk		11.10***
01300 - Scheduler, Maintenance		15.55***
01311 - Secretary I		15.55***
01312 - Secretary II		17.40
01313 - Secretary III		19.39
01320 - Service Order Dispatcher		15.40***
01410 - Supply Technician		21.43
01420 - Survey Worker		16.96
01460 - Switchboard Operator/Receptionist		10.78***
01531 - Travel Clerk I		13.01***
01532 - Travel Clerk II		14.12***
01533 - Travel Clerk III		15.09***
01611 - Word Processor I		14.53***

GSWA PROCUREMENT RECORD Page 400

01612 - Word Processor II	16.31
01613 - Word Processor III	18.26
05000 - Automotive Service Occupations	
05005 - Automobile Body Repairer, Fiberglass	17.20
05010 - Automotive Electrician	16.16***
05040 - Automotive Glass Installer	15.11***
05070 - Automotive Worker	15.11***
05110 - Mobile Equipment Servicer	12.96***
05130 - Motor Equipment Metal Mechanic	17.20
05160 - Motor Equipment Metal Worker	15.11***
05190 - Motor Vehicle Mechanic	17.20
05220 - Motor Vehicle Mechanic Helper	11.87***
05250 - Motor Vehicle Upholstery Worker	14.06***
05280 - Motor Vehicle Wrecker	15.11***
05310 - Painter, Automotive	16.16***
05340 - Radiator Repair Specialist	15.11***
05370 - Tire Repairer	12.67***
05400 - Transmission Repair Specialist	17.20
07000 - Food Preparation And Service Occupations	
07010 - Baker	11.10***
07041 - Cook I	14.44***
07042 - Cook II	16.84
07070 - Dishwasher	9.69***
07130 - Food Service Worker	10.11***
07210 - Meat Cutter	13.34***
07260 - Waiter/Waitress	9.73***
09000 - Furniture Maintenance And Repair Occupations	
09010 - Electrostatic Spray Painter	18.75
09040 - Furniture Handler	11.37***
09080 - Furniture Refinisher	18.75
09090 - Furniture Refinisher Helper	13.77***
09110 - Furniture Repairer, Minor	16.32
09130 - Upholsterer	18.75
11000 - General Services And Support Occupations	
11030 - Cleaner, Vehicles	9.69***
11060 - Elevator Operator	9.69***
11090 - Gardener	14.28***
11122 - Housekeeping Aide	10.13***
11150 - Janitor	10.13***
11210 - Laborer, Grounds Maintenance	10.79***
11240 - Maid or Houseman	9.67***
11260 - Pruner	9.66***
11270 - Tractor Operator	13.07***
11330 - Trail Maintenance Worker	10.79***
11360 - Window Cleaner	11.32***
12000 - Health Occupations	
12010 - Ambulance Driver	18.96
12011 - Breath Alcohol Technician	18.96
12012 - Certified Occupational Therapist Assistant	26.02
12015 - Certified Physical Therapist Assistant	26.02
12020 - Dental Assistant	18.79
12025 - Dental Hygienist	39.73
12030 - EKG Technician	28.73
12035 - Electroneurodiagnostic Technologist	28.73
12040 - Emergency Medical Technician	18.96
12071 - Licensed Practical Nurse I	16.95
12072 - Licensed Practical Nurse II	18.96
12073 - Licensed Practical Nurse III	21.14
12100 - Medical Assistant	13.42***
12130 - Medical Laboratory Technician	18.82
12160 - Medical Record Clerk	14.97***
12190 - Medical Record Technician	17.77
12195 - Medical Transcriptionist	16.95
12210 - Nuclear Medicine Technologist	41.68
12221 - Nursing Assistant I	12.43***
12222 - Nursing Assistant II	13.97***
12223 - Nursing Assistant III	15.24***
12224 - Nursing Assistant IV	17.12
12235 - Optical Dispenser	18.96
12236 - Optical Technician	16.95
12250 - Pharmacy Technician	15.49***
12280 - Phlebotomist	16.95
12305 - Radiologic Technologist	28.73
12311 - Registered Nurse I	23.50
12312 - Registered Nurse II	28.73
12313 - Registered Nurse II, Specialist	28.73
12314 - Registered Nurse III	34.76
12315 - Registered Nurse III, Anesthetist	34.76
12316 - Registered Nurse IV	41.68
12317 - Scheduler (Drug and Alcohol Testing)	23.50

GSWA PROCUREMENT RECORD Page 401

12320 - Substance Abuse Treatment Counselor	23.50
13000 - Information And Arts Occupations	
13011 - Exhibits Specialist I	21.42
13012 - Exhibits Specialist II	26.53
13013 - Exhibits Specialist III	32.45
13041 - Illustrator I	21.42
13042 - Illustrator II	26.53
13043 - Illustrator III	32.45
13047 - Librarian	29.38
13050 - Library Aide/Clerk	17.05
13054 - Library Information Technology Systems Administrator	26.53
13058 - Library Technician	18.11
13061 - Media Specialist I	19.15
13062 - Media Specialist II	21.42
13063 - Media Specialist III	23.87
13071 - Photographer I	19.15
13072 - Photographer II	21.42
13073 - Photographer III	26.53
13074 - Photographer IV	32.45
13075 - Photographer V	39.27
13090 - Technical Order Library Clerk	21.42
13110 - Video Teleconference Technician	19.15
14000 - Information Technology Occupations	
14041 - Computer Operator I	15.71***
14042 - Computer Operator II	17.22
14043 - Computer Operator III	19.19
14044 - Computer Operator IV	21.33
14045 - Computer Operator V	23.62
14071 - Computer Programmer I	(see 1) 15.73***
14072 - Computer Programmer II	(see 1) 19.50
14073 - Computer Programmer III	(see 1) 23.84
14074 - Computer Programmer IV	(see 1)
14101 - Computer Systems Analyst I	(see 1) 24.23
14102 - Computer Systems Analyst II	(see 1)
14103 - Computer Systems Analyst III	(see 1)
14150 - Peripheral Equipment Operator	15.71***
14160 - Personal Computer Support Technician	21.33
14170 - System Support Specialist	21.24
15000 - Instructional Occupations	
15010 - Aircrew Training Devices Instructor (Non-Rated)	24.23
15020 - Aircrew Training Devices Instructor (Rated)	29.32
15030 - Air Crew Training Devices Instructor (Pilot)	34.91
15050 - Computer Based Training Specialist / Instructor	24.23
15060 - Educational Technologist	29.40
15070 - Flight Instructor (Pilot)	34.91
15080 - Graphic Artist	20.47
15085 - Maintenance Test Pilot, Fixed, Jet/Prop	34.91
15086 - Maintenance Test Pilot, Rotary Wing	34.91
15088 - Non-Maintenance Test/Co-Pilot	34.91
15090 - Technical Instructor	17.67
15095 - Technical Instructor/Course Developer	23.78
15110 - Test Proctor	15.70***
15120 - Tutor	15.70***
16000 - Laundry, Dry-Cleaning, Pressing And Related Occupations	
16010 - Assembler	10.83***
16030 - Counter Attendant	10.83***
16040 - Dry Cleaner	12.36***
16070 - Finisher, Flatwork, Machine	10.83***
16090 - Presser, Hand	10.83***
16110 - Presser, Machine, Drycleaning	10.83***
16130 - Presser, Machine, Shirts	10.83***
16160 - Presser, Machine, Wearing Apparel, Laundry	10.83***
16190 - Sewing Machine Operator	12.88***
16220 - Tailor	13.40***
16250 - Washer, Machine	11.34***
19000 - Machine Tool Operation And Repair Occupations	
19010 - Machine-Tool Operator (Tool Room)	19.46
19040 - Tool And Die Maker	24.46
21000 - Materials Handling And Packing Occupations	
21020 - Forklift Operator	15.36***
21030 - Material Coordinator	22.97
21040 - Material Expediter	22.97
21050 - Material Handling Laborer	12.57***
21071 - Order Filler	10.62***
21080 - Production Line Worker (Food Processing)	15.36***
21110 - Shipping Packer	17.12
21130 - Shipping/Receiving Clerk	17.12
21140 - Store Worker I	15.83***
21150 - Stock Clerk	22.26

GSWA PROCUREMENT RECORD Page 402

21210 - Tools And Parts Attendant	15.36***
21410 - Warehouse Specialist	15.36***
23000 - Mechanics And Maintenance And Repair Occupations	
23010 - Aerospace Structural Welder	25.04
23019 - Aircraft Logs and Records Technician	19.47
23021 - Aircraft Mechanic I	23.84
23022 - Aircraft Mechanic II	25.04
23023 - Aircraft Mechanic III	26.30
23040 - Aircraft Mechanic Helper	16.58
23050 - Aircraft, Painter	22.39
23060 - Aircraft Servicer	19.47
23070 - Aircraft Survival Flight Equipment Technician	22.39
23080 - Aircraft Worker	21.03
23091 - Aircrew Life Support Equipment (ALSE) Mechanic I	21.03
23092 - Aircrew Life Support Equipment (ALSE) Mechanic II	23.84
23110 - Appliance Mechanic	19.46
23120 - Bicycle Repairer	15.61***
23125 - Cable Splicer	22.47
23130 - Carpenter, Maintenance	17.58
23140 - Carpet Layer	18.20
23160 - Electrician, Maintenance	19.37
23181 - Electronics Technician Maintenance I	18.20
23182 - Electronics Technician Maintenance II	19.46
23183 - Electronics Technician Maintenance III	20.72
23260 - Fabric Worker	16.94
23290 - Fire Alarm System Mechanic	16.77
23310 - Fire Extinguisher Repairer	15.61***
23311 - Fuel Distribution System Mechanic	20.72
23312 - Fuel Distribution System Operator	15.61***
23370 - General Maintenance Worker	13.24***
23380 - Ground Support Equipment Mechanic	23.84
23381 - Ground Support Equipment Servicer	19.47
23382 - Ground Support Equipment Worker	21.03
23391 - Gunsmith I	15.61***
23392 - Gunsmith II	18.20
23393 - Gunsmith III	20.72
23410 - Heating, Ventilation And Air-Conditioning Mechanic	19.27
23411 - Heating, Ventilation And Air Contidioning Mechanic (Research Facility)	20.50
23430 - Heavy Equipment Mechanic	19.50
23440 - Heavy Equipment Operator	18.10
23460 - Instrument Mechanic	20.72
23465 - Laboratory/Shelter Mechanic	19.46
23470 - Laborer	12.57***
23510 - Locksmith	19.46
23530 - Machinery Maintenance Mechanic	23.13
23550 - Machinist, Maintenance	20.72
23580 - Maintenance Trades Helper	11.77***
23591 - Metrology Technician I	20.72
23592 - Metrology Technician II	22.03
23593 - Metrology Technician III	23.33
23640 - Millwright	20.72
23710 - Office Appliance Repairer	19.46
23760 - Painter, Maintenance	17.04
23790 - Pipefitter, Maintenance	19.96
23810 - Plumber, Maintenance	18.75
23820 - Pneudraulic Systems Mechanic	20.72
23850 - Rigger	20.72
23870 - Scale Mechanic	18.20
23890 - Sheet-Metal Worker, Maintenance	19.55
23910 - Small Engine Mechanic	18.20
23931 - Telecommunications Mechanic I	19.96
23932 - Telecommunications Mechanic II	21.24
23950 - Telephone Lineman	20.62
23960 - Welder, Combination, Maintenance	19.96
23965 - Well Driller	21.13
23970 - Woodcraft Worker	20.71
23980 - Woodworker	15.61***
24000 - Personal Needs Occupations	
24550 - Case Manager	15.01***
24570 - Child Care Attendant	10.09***
24580 - Child Care Center Clerk	13.25***
24610 - Chore Aide	14.06***
24620 - Family Readiness And Support Services Coordinator	15.01***
24630 - Homemaker	16.12***
25000 - Plant And System Operations Occupations	

GSWA PROCUREMENT RECORD Page 403

25010 - Boiler Tender	22.79
25040 - Sewage Plant Operator	22.89
25070 - Stationary Engineer	22.79
25190 - Ventilation Equipment Tender	15.72***
25210 - Water Treatment Plant Operator	22.89
27000 - Protective Service Occupations	
27004 - Alarm Monitor	10.90***
27007 - Baggage Inspector	9.63***
27008 - Corrections Officer	14.59***
27010 - Court Security Officer	14.59***
27030 - Detection Dog Handler	10.90***
27040 - Detention Officer	14.59***
27070 - Firefighter	14.59***
27101 - Guard I	9.63***
27102 - Guard II	10.90***
27131 - Police Officer I	14.59***
27132 - Police Officer II	16.21
28000 - Recreation Occupations	
28041 - Carnival Equipment Operator	13.24***
28042 - Carnival Equipment Repairer	14.46***
28043 - Carnival Worker	9.78***
28210 - Gate Attendant/Gate Tender	13.18***
28310 - Lifeguard	11.01***
28350 - Park Attendant (Aide)	14.74***
28510 - Recreation Aide/Health Facility Attendant	11.84***
28515 - Recreation Specialist	18.26
28630 - Sports Official	11.74***
28690 - Swimming Pool Operator	17.71
29000 - Stevedoring/Longshoremen Occupational Services	
29010 - Blocker And Bracer	26.02
29020 - Hatch Tender	26.02
29030 - Line Handler	26.02
29041 - Stevedore I	24.21
29042 - Stevedore II	27.82
30000 - Technical Occupations	
30010 - Air Traffic Control Specialist, Center (HFO) (see 2)	43.06
30011 - Air Traffic Control Specialist, Station (HFO) (see 2)	29.69
30012 - Air Traffic Control Specialist, Terminal (HFO) (see 2)	32.70
30021 - Archeological Technician I	18.17
30022 - Archeological Technician II	20.33
30023 - Archeological Technician III	25.19
30030 - Cartographic Technician	25.19
30040 - Civil Engineering Technician	25.19
30051 - Cryogenic Technician I	27.89
30052 - Cryogenic Technician II	30.80
30061 - Drafter/CAD Operator I	18.17
30062 - Drafter/CAD Operator II	20.33
30063 - Drafter/CAD Operator III	22.66
30064 - Drafter/CAD Operator IV	27.89
30081 - Engineering Technician I	16.19***
30082 - Engineering Technician II	18.17
30083 - Engineering Technician III	20.33
30084 - Engineering Technician IV	25.19
30085 - Engineering Technician V	30.80
30086 - Engineering Technician VI	37.27
30090 - Environmental Technician	25.19
30095 - Evidence Control Specialist	25.19
30210 - Laboratory Technician	22.66
30221 - Latent Fingerprint Technician I	27.89
30222 - Latent Fingerprint Technician II	30.80
30240 - Mathematical Technician	25.19
30361 - Paralegal/Legal Assistant I	19.54
30362 - Paralegal/Legal Assistant II	24.21
30363 - Paralegal/Legal Assistant III	29.61
30364 - Paralegal/Legal Assistant IV	35.83
30375 - Petroleum Supply Specialist	30.80
30390 - Photo-Optics Technician	24.92
30395 - Radiation Control Technician	30.80
30461 - Technical Writer I	25.19
30462 - Technical Writer II	30.80
30463 - Technical Writer III	37.27
30491 - Unexploded Ordnance (UXO) Technician I	27.37
30492 - Unexploded Ordnance (UXO) Technician II	33.11
30493 - Unexploded Ordnance (UXO) Technician III	39.69
30494 - Unexploded (UXO) Safety Escort	27.37
30495 - Unexploded (UXO) Sweep Personnel	27.37
30501 - Weather Forecaster I	27.89
30502 - Weather Forecaster II	33.93
30620 - Weather Observer, Combined Upper Air Or Surface Programs (see 2)	22.66

GSWA PROCUREMENT RECORD Page 404

30621 - Weather Observer, Senior	(see 2)	25.19
31000 - Transportation/Mobile Equipment Operation Occupations		
31010 - Airplane Pilot		33.11
31020 - Bus Aide		8.97***
31030 - Bus Driver		11.73***
31043 - Driver Courier		10.26***
31260 - Parking and Lot Attendant		9.91***
31290 - Shuttle Bus Driver		11.65***
31310 - Taxi Driver		11.41***
31361 - Truckdriver, Light		11.21***
31362 - Truckdriver, Medium		12.16***
31363 - Truckdriver, Heavy		16.11***
31364 - Truckdriver, Tractor-Trailer		16.11***
99000 - Miscellaneous Occupations		
99020 - Cabin Safety Specialist		16.14***
99030 - Cashier		10.01***
99050 - Desk Clerk		9.71***
99095 - Embalmer		27.37
99130 - Flight Follower		27.37
99251 - Laboratory Animal Caretaker I		24.31
99252 - Laboratory Animal Caretaker II		26.56
99260 - Marketing Analyst		21.54
99310 - Mortician		27.37
99410 - Pest Controller		16.07***
99510 - Photofinishing Worker		14.38***
99710 - Recycling Laborer		17.32
99711 - Recycling Specialist		23.38
99730 - Refuse Collector		16.40
99810 - Sales Clerk		10.63***
99820 - School Crossing Guard		17.96
99830 - Survey Party Chief		23.99
99831 - Surveying Aide		13.65***
99832 - Surveying Technician		17.73
99840 - Vending Machine Attendant		24.31
99841 - Vending Machine Repairer		30.96
99842 - Vending Machine Repairer Helper		24.31

Joh

***Workers in this classification may be entitled to a higher minimum wage under Executive Order 14026 (\$16.20 per hour). Please see the Note at the top of the wage determination for more information. Please also note that the minimum wage requirements of Executive Order 14026 are not currently being enforced as to contracts or contract-like instruments entered into with the federal government in connection with seasonal recreational services or seasonal recreational equipment rental for the general public on federal lands.

ALL OCCUPATIONS LISTED ABOVE RECEIVE THE FOLLOWING BENEFITS:

HEALTH & WELFARE: \$4.98 per hour, up to 40 hours per week, or \$199.20 per week or \$863.20 per month

HEALTH & WELFARE EO 13706: \$4.57 per hour, up to 40 hours per week, or \$182.80 per week, or \$792.13 per month*

*This rate is to be used only when compensating employees for performance on an SCA-covered contract also covered by EO 13706, Establishing Paid Sick Leave for Federal Contractors. A contractor may not receive credit toward its SCA obligations for any paid sick leave provided pursuant to EO 13706.

VACATION: 2 weeks paid vacation after 1 year of service with a contractor or successor; and 4 weeks after 3 years. Length of service includes the whole span of continuous service with the present contractor or successor, wherever employed, and with the predecessor contractors in the performance of similar work at the same Federal facility. (Reg. 29 CFR 4.173)

HOLIDAYS: A minimum of eleven paid holidays per year: New Year's Day, Martin Luther King Jr.'s Birthday, Washington's Birthday, Memorial Day, Juneteenth National Independence Day, Independence Day, Labor Day, Columbus Day, Veterans' Day, Thanksgiving Day, and Christmas Day. (A contractor may substitute for any of the named holidays another day off with pay in accordance with a plan communicated to the employees involved.) (See 29 CFR 4.174)

THE OCCUPATIONS WHICH HAVE NUMBERED FOOTNOTES IN PARENTHESES RECEIVE THE FOLLOWING:

1) **COMPUTER EMPLOYEES:** This wage determination does not apply to any individual employed in a bona fide executive, administrative, or professional capacity, as defined in 29 C.F.R. Part 541. (See 41 C.F.R. 6701(3)). Because most Computer Systems Analysts and Computer Programmers who are paid at least \$27.63 per hour (or at least \$684 per week if paid on a salary or fee basis) likely qualify as exempt computer professionals under 29 U.S.C. 213(a)(1) and 29 U.S.C. 213(a)(17), this wage determination may not include wage rates for all occupations within those job families. In such instances, a conformance will be necessary if there are nonexempt employees in these job families working on the contract.

Job titles vary widely and change quickly in the computer industry, and are not determinative of whether an employee is an exempt computer professional. To be exempt, computer employees who satisfy the compensation requirements must also have a primary duty that consists of:

(1) The application of systems analysis techniques and procedures, including consulting with users, to determine hardware, software or system functional specifications;

(2) The design, development, documentation, analysis, creation, testing or modification of computer systems or programs, including prototypes, based on and related to user or system design specifications;

(3) The design, documentation, testing, creation or modification of computer programs related to machine operating systems; or

(4) A combination of the aforementioned duties, the performance of which requires the same level of skills. (29 C.F.R. 541.400).

Any computer employee who meets the applicable compensation requirements and the above duties test qualifies as an exempt computer professional under both section 13(a)(1) and section 13(a)(17) of the Fair Labor Standards Act. (Field Assistance Bulletin No. 2006-3 (Dec. 14, 2006)). Accordingly, this wage determination will not apply to any exempt computer employee regardless of which of these two exemptions is utilized.

2) **AIR TRAFFIC CONTROLLERS AND WEATHER OBSERVERS - NIGHT PAY & SUNDAY PAY:** If you work at night as part of a regular tour of duty, you will earn a night differential and receive an additional 10% of basic pay for any hours worked between 6pm and 6am. If you are a full-time employed (40 hours a week) and Sunday is part of your regularly scheduled workweek, you are paid at your rate of basic pay plus a Sunday premium of 25% of your basic rate for each hour of Sunday work which is not overtime (i.e. occasional work on Sunday outside the normal tour of duty is considered overtime work).

**** HAZARDOUS PAY DIFFERENTIAL ****

An 8 percent differential is applicable to employees employed in a position that represents a high degree of hazard when working with or in close proximity to ordnance, explosives, and incendiary materials. This includes work such as screening, blending, dying, mixing, and pressing of sensitive ordnance, explosives, and pyrotechnic compositions such as lead azide, black powder and photoflash powder. All dry-house activities involving propellants or explosives. Demilitarization, modification, renovation, demolition, and maintenance operations on sensitive ordnance, explosives and incendiary materials. All operations involving re-grading and cleaning of artillery ranges.

A 4 percent differential is applicable to employees employed in a position that represents a low degree of hazard when working with, or in close proximity to ordnance, (or employees possibly adjacent to) explosives and incendiary materials which involves potential injury such as laceration of hands, face, or arms of the employee engaged in the operation, irritation of the skin, minor burns and the like; minimal damage to immediate or adjacent work area or equipment being used. All operations involving, unloading, storage, and hauling of ordnance, explosive, and incendiary ordnance material other than small arms ammunition. These differentials are only applicable to work that has been specifically designated by the agency for ordnance, explosives, and incendiary material differential pay.

**** UNIFORM ALLOWANCE ****

If employees are required to wear uniforms in the performance of this contract (either by the terms of the Government contract, by the employer, by the state or local law, etc.), the cost of furnishing such uniforms and maintaining (by laundering or dry cleaning) such uniforms is an expense that may not be borne by an employee where such cost reduces the hourly rate below that required by the wage determination. The Department of Labor will accept payment in accordance with the following standards as compliance:

The contractor or subcontractor is required to furnish all employees with an adequate number of uniforms without cost or to reimburse employees for the actual cost of the uniforms. In addition, where uniform cleaning and maintenance is made the responsibility of the employee, all contractors and subcontractors subject to this wage determination shall (in the absence of a bona fide collective bargaining agreement providing for a different amount, or the furnishing of contrary affirmative proof as to the actual cost), reimburse all employees for such cleaning and maintenance at a rate of \$3.35 per week (or \$.67 cents per day). However, in those instances where the uniforms furnished are made of "wash and wear" materials, may be routinely washed and dried with other personal garments, and do not require any special treatment such as dry cleaning, daily washing, or commercial laundering in order to meet the cleanliness or appearance standards set by the terms of the Government contract, by the contractor, by law, or by the nature of the work, there is no requirement that employees be reimbursed for uniform maintenance costs.

**** SERVICE CONTRACT ACT DIRECTORY OF OCCUPATIONS ****

The duties of employees under job titles listed are those described in the "Service Contract Act Directory of Occupations", Fifth Edition (Revision 1), dated September 2015, unless otherwise indicated.

**** REQUEST FOR AUTHORIZATION OF ADDITIONAL CLASSIFICATION AND WAGE RATE, Standard Form 1444 (SF-1444) ****

Conformance Process:

The contracting officer shall require that any class of service employee which is not listed herein and which is to be employed under the contract (i.e., the work to be performed is not performed by any classification listed in the wage determination), be classified by the contractor so as to provide a reasonable relationship (i.e., appropriate level of skill comparison) between such unlisted classifications and the classifications listed in the wage determination (See 29 CFR 4.6(b)(2)(i)). Such conforming procedures shall be initiated by the contractor prior to the performance of contract work by such unlisted class(es) of employees (See 29 CFR 4.6(b)(2)(ii)). The Wage and Hour Division shall make a final determination of conformed classification, wage rate, and/or fringe benefits which shall be paid to all employees performing in the classification from the first day of work on which contract work is performed by them in the classification. Failure to pay such unlisted employees the compensation agreed upon by the interested parties and/or fully determined by the Wage and Hour Division retroactive to the date such class of employees commenced contract work shall be a violation of the Act and this contract. (See 29 CFR 4.6(b)(2)(v)). When multiple wage determinations are included in a contract, a separate SF-1444 should be prepared for each wage determination to which a class(es) is to be conformed.

The process for preparing a conformance request is as follows:

- 1) When preparing the bid, the contractor identifies the need for a conformed occupation(s) and computes a proposed rate(s).
- 2) After contract award, the contractor prepares a written report listing in order the proposed classification title(s), a Federal grade equivalency (FGE) for each proposed classification(s), job description(s), and rationale for proposed wage rate(s), including information regarding the agreement or disagreement of the authorized representative of the employees involved, or where there is no authorized representative, the employees themselves. This report should be submitted to the contracting officer no later than 30 days after such unlisted class(es) of employees performs any contract work.
- 3) The contracting officer reviews the proposed action and promptly submits a report of the action, together with the agency's recommendations and pertinent information including the position of the contractor and the employees, to the U.S. Department of Labor, Wage and Hour Division, for review (See 29 CFR 4.6(b)(2)(ii)).
- 4) Within 30 days of receipt, the Wage and Hour Division approves, modifies, or disapproves the action via transmittal to the agency contracting officer, or notifies the contracting officer that additional time will be required to process the request.
- 5) The contracting officer transmits the Wage and Hour Division's decision to the contractor.
- 6) Each affected employee shall be furnished by the contractor with a written copy of such determination or it shall be posted as a part of the wage determination (See 29 CFR 4.6(b)(2)(iii)).

Information required by the Regulations must be submitted on SF-1444 or bond paper.

When preparing a conformance request, the "Service Contract Act Directory of Occupations" should be used to compare job definitions to ensure that duties requested are not performed by a classification already listed in the wage determination. Remember, it is not the job title, but the required tasks that determine whether a class is included in an established wage determination. Conformances may not be used to artificially split, combine, or subdivide classifications listed in the wage determination (See 29 CFR 4.152(c)(1))."

AFFIDAVIT re CONTINGENT FEES

CITY OF Hagatna)
) ss.
ISLAND OF GUAM)

John Alexius Lintiaco Jr. [state name of affiant signing below], being first duly sworn, deposes and says that:

1. The name of the offering company or individual is [state name of company] Far East Equipment Company, LLC

2. As a part of the offering company's bid or proposal, to the best of my knowledge, the offering company has not retained any person or agency on a percentage, commission, or other contingent arrangement to secure this contract. This statement is made pursuant to 2 GAR Division 4 11108(f).

3. As a part of the offering company's bid or proposal, to the best of my knowledge, the offering company has not retained a person to solicit or secure a contract with the government of Guam upon an agreement or understanding for a commission, percentage, brokerage, or contingent fee, except for retention of bona fide employees or bona fide established commercial selling agencies for the purpose of securing business. This statement is made pursuant to 2 GAR Division 4 11108(h).

4. I make these statements on behalf of myself as a representative of the offeror, and on behalf of the offeror's officers, representatives, agents, subcontractors, and employees.

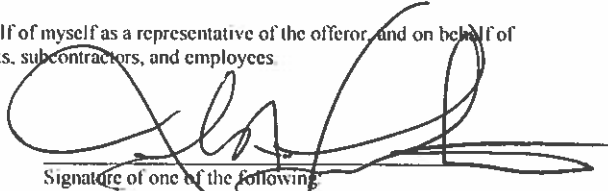

Signature of one of the following:
Offeror, if the offeror is an individual.
Partner, if the offeror is a partnership.
Officer, if the offeror is a corporation.

Subscribed and sworn to before me

this 17th day of November, 2023



NOTARY PUBLIC
My commission expires November 03, 2025

RENEE ANN C. WADE
NOTARY PUBLIC
In and for the Territory of Guam, U.S.A.
My Commission Expires: **NOV. 03, 2025**
111 Chalan Santo Papa Hagåtña, Guam 96910



CERTIFICATION OF NON-EMPLOYMENT OF CONVICTED SEXUAL OFFENDERS

Pursuant to Guam Public Law 28-24, as amended by Guam Public Law 28-98, if a contract for services is awarded to an Offeror, then the service provider must warrant that no person in its employment who has been convicted of a sex offense under the provisions of Chapter 25 of Title 9 of the Guam Code Annotated or of an offense defined in Article 2 of Chapter 28 of Title 9 of the Guam Code Annotated, or who has been convicted in any other jurisdiction of an offense with the same elements as heretofore defined, or who is listed on the Sex Offender Registry, shall provide services on behalf of the service provider while on government of Guam property, with the exception of public highways. If any employee of a service provider is providing services on government property and is convicted subsequent to an award of a contract, then the service provider warrants that it will notify the GSWA of the conviction within twenty-four hours of the conviction and will immediately remove such convicted person from providing services on government of Guam property. If the service provider is found to be in violation of any of the provisions of this paragraph, then the GSWA will give notice to the service provider to take corrective action. The service provider shall take corrective action within twenty-four hours of notice from the GSWA, and the service provider shall notify the GSWA when action has been taken. If the service provider fails to take corrective steps within twenty-four hours of notice from the GSWA, then the GSWA in its sole discretion may suspend temporarily any contract for services.

I, John Alexius Limtiaco Jr. being a duly authorized representative of the Offeror,
(print name)

acknowledge the requirements described above, have ensured that the Proposal as submitted addresses these requirements, and certify that if awarded the contract, the Offeror will follow these mandates.

Far East Equipment Company, LLC
(Company Name)

President
(Title)

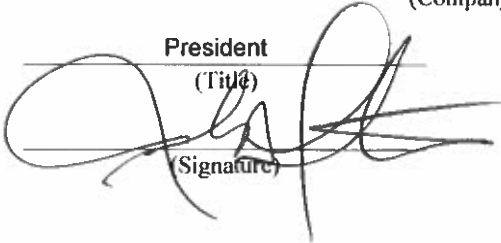

(Signature)

(Date)



GUAM SOLID WASTE AUTHORITY
546 NORTH MARINE CORPS DRIVE TAMUNING, GUAM 96913
TEL: (671) 646-3111 | FAX: (671) 649-3777
WWW.GUAMSOLIDWASTEAUTHORITY.COM

BID BOND

NO. _____

KNOW ALL MEN BY THESE PRESENTS that _____, as Principal Hereinafter called the Principal, and (Bonding Company), _____ A duly admitted insurer under the laws of the Territory of Guam, Surety, hereinafter called the Surety are held firmly bound unto the Territory of Guam for the sum of _____ Dollars (\$ _____), for Payment of which sum will and truly to be made, the said Principal and the said Surety bind ourselves, our heirs, executors, administrators, successors and assigns, jointly and severally, firmly by these presents.

WHEREAS, the Principal has submitted a bid for (identify project by number and brief description)

NOW, THEREFORE, if the Territory of Guam shall accept the bid of the Principal and the Principal shall enter into a contract with the Territory of Guam in accordance with the terms of such bid, and give such bond or bonds as may be specified in bidding or Contract Documents with good and sufficient surety for the faithful performance of such Contract and for the prompt payment of labor and material furnished in the prosecution thereof, or in the event of the failure of the Principal to enter such Contract and give such bond or bonds, if the Principal shall pay to the Territory of Guam the difference not to exceed the penalty hereof between the amounts specified in said bid and such larger amount for which the Territory of Guam may in good faith contract with another part to perform work covered by said bid or an appropriate liquidated amount as specified in the Invitation for Bids then this obligation shall be null and void, otherwise to remain full force and effect.

Signed and sealed this _____ day of _____ 20_____.

(PRINCIPAL)

(SEAL)

(WITNESS)

(TITLE)

(MAJOR OFFICER OF SURETY)

(TITLE)

(MAJOR OFFICER OF SURETY)

(TITLE)

(RESIDENTIAL GENERAL AGENT)

SEE INSTRUCTIONS IN BACK PAGE FOR SUPPORTING DOCUMENTS REQUIRED.



Headquarters

P.O. Box BW Hagåtña, Guam 96932

Tel: (671) 472-5300

Member FDIC

December 4, 2023

LC No.: 01-SB-1947

Dated: December 4, 2023

Amount: \$38,000.00

Guam Solid Waste Authority
546 N. Marine Corp Drive
Tamuning, Guam 96913

Applicant: Far East Equipment Company, LLC.
17-3311 Corsair Road Tiyan
Barrigada, Guam 96913

Beneficiary: Guam Solid Waste Authority
546 N. Marine Corp Drive
Tamuning, Guam 96913

To Guam Solid Waste Authority:

We hereby enclose our Irrevocable Standby Letter of Credit no. 01-SB-1947 dated December 4, 2023 in the amount of \$38,000.00 in your favor for the account of Far East Equipment Company, LLC.

Please contact us should you have any questions.

Sincerely,
BANK OF GUAM



Ramona Toves
Credits Officer

ramona.toves@bankofguam.com

Phone: (671) 472-5152



Bank of Guam®

Tel: (671) 472-5300

Headquarters • 111 Chalan Santo Papa, Hagåtña, Guam 96910

LETTER OF CREDIT Irrevocable Standby

Date December 4, 2023

Letter of Credit No. 01-SB-1947

Amount \$38,000.00

Expiration Date March 4, 2024

APPLICANT:

Far East Equipment Company, LLC.
17-3311 Corsair Road Tiyan
Barrigada, Guam 96913

BENEFICIARY:

Guam Solid Waste Authority
546 N. Marine Corp Drive
Tamuning, Guam 96913

To Guam Solid Waste Authority:

We hereby establish our Irrevocable Standby Letter of Credit No. 01-SB-1947 in your favor for the account of Far East Equipment Company, LLC., 17-3311 Corsair Road Tiyan, Barrigada, Guam 96913 up to the aggregated amount of \$38,000.00 (Thirty-eight Thousand and no/100) available by your drafts drawn at SIGHT on Bank of Guam, 111 Chalan Santo Papa, Hagatna, Guam 96910 and accompanied by documents specified as follows:

- 1) Beneficiary's signed certificate stating that the applicant has defaulted on the terms and conditions set forth under Invitation for Bid No. GSWA-004-24 for Compact Wheel Loader w/ Attachments.
- 2) The original Letter of Credit and all Amendments, if any.

Partial drawings under this credit are not allowed.

We hereby agree with you that all drafts drawn under and in compliance with the terms of this credit shall be met with due honor upon presentation and delivery of documents as specified to the drawee if drawn and presented for negotiation on or before March 4, 2024.

All documents are to be marked with Bank of Guam reference no. 01-SB-1947 and are to be forwarded to Bank of Guam, Headquarters, Attn: Letters of Credit Department, 111 Chalan Santo Papa, Hagatna, Guam 96910.

***** E N D *****

Sincerely,
BANK OF GUAM

BY
Authorized Signer: Janine Eustaquio - VP/Credit Officer

BY
Authorized Signer: Ramona Toves - PAC/Credit Officer

PROVISIONS APPLICABLE TO THIS CREDIT: This credit is subject to the Uniform Customs and Practice for Documentary Credits (2007 Provision) International Chamber of Commerce Publication No. 600.

INSTRUCTION TO PROVIDERS:

NOTICE to all Insurance and Bonding Institutions:

The Bond requires the signatures of the Vendor, two (2) major Officers of the Surety and Resident General Agent, if the Surety is a foreigner or alien surety.

When the form is submitted to the Guam Solid Waste Authority, it should be accompanied with copies of the following:

1. Current Certificate of Authority to do business on Guam Issued by the Department of Revenue and Taxation.
2. Power Of Attorney issued by the Surety to the Resident General Agent.
3. Power of Attorney issued by two (2) major officers of the Surety to whoever is signing on their behalf.

Bonds, submitted as Bid Guarantee, without signatures and supporting documents are invalid and Bids will be rejected.



DEPARTMENT OF REVENUE AND TAXATION

GOVERNMENT OF GUAM

P.O. Box 23607

Barrigada, Guam 96921

www.guamtax.com

BUSINESS LICENSE

SERIAL # 2410961

Ltd Liability Company

EXPIRES: June 30, 2024

Service

ACCOUNT NO. 13-200600764-01

R

ISSUED TO:	FAR EAST EQUIPMENT COMPANY, LLC	FEE	50 00
DOING BUSINESS AS:	FAR EAST EQUIPMENT COMPANY, LLC	PENALTY	0 00
TYPE OF LICENSE:	REPAIR OF AUTOMOTIVES TRUCKS BUSES HEAVY & INDUSTRIAL EQUIPMENTS	TOTAL FEE	50 00
BUSINESS LOCATION:	#17-3311 CORSAIR RD TIYAN BARRIGADA GUAM		
MAILING ADDRESS:	P O BOX 10838 TAMUNING GUAM		
TELEPHONE: HOME			

96931
BUSINESS 888-6270

06/29/2023

**KEEP POSTED IN A CONSPICUOUS PLACE.
LICENSE MUST BE PRODUCED UPON
DEMAND TO ANY AUTHORIZED GOVT
OFFICIAL.**

DIRECTOR OF REVENUE AND TAXATION

Dafne Mansapit-Snimizu





DEPARTMENT OF REVENUE AND TAXATION

GOVERNMENT OF GUAM

P.O. Box 23607
Barrigada, Guam 96921
www.guamlax.com

BUSINESS LICENSE

SERIAL # 2410964

Ltd Liability Company

EXPIRES: June 30, 2024

Retail

R

ACCOUNT NO. 30-200600764-01

FEE	1,000 00
PENALTY	0 00
TOTAL FEE	1,000 00

ISSUED TO: FAR EAST EQUIPMENT COMPANY, LLC

DOING BUSINESS AS: FAR EAST EQUIPMENT COMPANY, LLC

TYPE OF LICENSE: SALE OF AUTOMOTIVES TRUCKS BUSES HEAVY & INDUSTRIAL EQUIPMENTS

BUSINESS LOCATION: #17-3311 CORSAIR RD

TIYAN BARRIGADA GUAM

MAILING ADDRESS: P O BOX 10838
TAMUNING GUAM

TELEPHONE: HOME 96931
BUSINESS 888-6270

06/29/2023

**KEEP POSTED IN A CONSPICUOUS PLACE.
LICENSE MUST BE PRODUCED UPON
DEMAND TO ANY AUTHORIZED GOV'T
OFFICIAL.**

Dafne Mansapit-Shimizu
Dafne Mansapit-Shimizu
DIRECTOR OF REVENUE AND TAXATION



GOVERNMENT OF GUAM

GENERAL TERMS AND CONDITIONS

SEALED BID SOLICITATION AND AWARD

ONLY THOSE BOXES CHECKED BELOW ARE APPLICABLE TO THIS BID

1. **AUTHORITY:**

This solicitation is issued subject to all the provisions of the Guam Procurement Act (5GCA, Chapter 5) and the Guam Procurement Regulations (copies of both are available at the Office of the Comptroller of Laws, Department of Law, copies available for inspection at the Guam Solid Waste Authority). It requires all parties involved in the Preparation, negotiation, performance, or administration of contracts to act in good faith.

2. **GENERAL INTENTION:** Unless otherwise specified, these General Terms and conditions are intended for the bidder to provide the Government of Guam (Government) with specified services or with materials, supplies or equipment completely assembled and ready for use.

3. **TAXES:** Bidders are cautioned that they are subject to Guam Income Taxes as well as all other taxes on Guam transactions. Specific information on taxes may be obtained from the Director of Revenue and Taxation.

4. **LICENSING:** Bidders are cautioned that the Government will not consider for award any offer submitted by a bidder who has not complied with the Guam Licensing law. Specific information on licenses may be obtained from the Director of Revenue and Taxation.

5. **LOCAL PROCUREMENT PREFERENCE:** All procurement of supplies and services where possible, will be made from among businesses licensed to do business on Guam in accordance with section 5008 of the Guam Procurement Act (5GCA, Chapter 5) and Section 1104 of the Guam Procurement Regulations.

6. **COMPLIANCE WITH SPECIFICATIONS AND OTHER SOLICITATION REQUIREMENTS:** Bidders shall comply with all specifications and other requirements of the Solicitation.

7. **"ALL OR NONE" BIDS:** Unless otherwise allowed under this Solicitation, "all or none" bids may be deemed to be non-responsive. If the bid is so limited, the Government may reject part of such proposal and award on the remainder.

NOTE: By checking this item, The Government is requesting all of the bid items to be items to be bid or none at all. The Government will not award on an itemized basis. Reference 3-101.06 of the Guam Procurement Regulations.

8. **INDEPENDENT PRICE DETERMINATION:** The bidder, upon signing the Invitation for Bid, certifies that the prices in his bid were derived without collusion, and acknowledges that collusion and anti-competitive practices are prohibited by law. Violations will be subject to the provision of Section 5651 of that of the Guam Procurement Act. Other existing civil, criminal or administrative remedies are not impaired and may be in addition to the remedies in Section 5651 of the Government code. By submitting a bid, the bidder certifies that its price was independently arrived at without collusion.

9. **BIDDER'S PRICE:** The Government will consider not more than two (2) (basic and Alternate) item prices and the bidder shall explain fully each price if supplies, materials, equipment, and/or specified services offered comply with specifications and the products origin. Where basic or alternate bid meets the minimum required specification, cost and other factors will be considered. Failure to explain this requirement will result in rejection of the bid.

10. **BID ENVELOPE:** Envelope shall be sealed and marked with the Bidder's name, Bid number, time, date and place of Bid opening.

11. **BID GUARANTEE REQUIREMENT:** Bidder is required to submit a Bid Guarantee Bond or standby irrevocable Letter of Credit or Certified Check or Cashier's Check in the same bid envelope to be held by the Government pending delivery of items being procured. The Bid Guarantee Bond, Letter of Credit, Certified Check or cashier's check must be issued by any local surety or banking institution licensed to do business on Guam and made payable to the Guam Solid Waste Authority in the amount of fifteen percent (15%) of the total bid offer. The Bid Bond must be submitted on Government Standard Form BB-1 (copy enclosed). Personal Checks will not be accepted as Bid Guarantee. If a successful Bidder (contractor) withdraws from the bid or fails to enter into contract within the prescribed time, such Bid guarantee will be forfeited to the Government of Guam. Bids will be disqualified if not accompanied by Bid Bond, Letter of Credit, Certified Check or Cashier's Check. Bidder must include in his/her bid, valid copies of a Power of Attorney from the Surety and a Certificate of Authority from the Government of Guam to show proof that the surety company named on the bond instrument is authorized by the Government of Guam to be qualified to do business on Guam. For detailed information on bonding matters, contact the Department of Revenue and Taxation. Failure to submit a valid Power of Attorney and Certificate of Authority on the surety is cause for rejection of bid. (GPR Section 3109(c)(3)) Pursuant to 5 GCA Section 5212, all competitive sealed bidding for the procurement of supplies or services exceeding \$25,000 must be accompanied by bid security in the amount of 15% of the total bid price.

12. **PERFORMANCE GUARANTEE:** Bidders, who are awarded a contract under this solicitation, guarantee that goods will be delivered or required services performed within the time specified. Failure to perform the contract in a satisfactory manner may be cause for suspension or debarment from doing business with the Government and for enforcement of Section 23 of these General terms and Conditions. In addition, the Government will hold the Vendor liable and will enforce the requirements as set forth in Section 41 of these General Terms and Conditions.

13. **SURETY BONDS:** Bid and Performance Bonds coverage must be signed or countersigned in Guam by a foreign or alien surety's resident general agent. The Surety must be an Insurance Company, authorized by the Government of Guam and qualified to do business in Guam. Bids will be disqualified if the Surety Company does not have a valid Certificate of Authority from the Government of Guam to conduct business in Guam.

14. **COMPETENCY OF BIDDERS:** Bids will be considered only from the such bidders who, in the opinion of the Government, can show evidence of their ability, experience, equipment, and facilities to render satisfactory service.

15. **DETERMINATION OF RESPONSIBILITY OF BIDDERS:** The Guam Solid Waste Authority reserves the right for securing from bidders information to determine whether or not they are responsible and to inspect plant site, place of business, and supplies and services as necessary to determine their responsibility in accordance with Section 15 of these General Terms and Conditions (GPR Section 3-401).

16. **STANDARD FOR DETERMINATION OF LOWEST RESPONSIBLE BIDDER:** In determining the lowest responsible offer, the Guam Solid Waste Authority shall be guided by the following:

- a) Price of Items offered.
- b) The ability, capacity, and skill of the Bidder to perform.
- c) Whether the bidder can perform promptly within the specified time.
- d) The quality of performance of the Bidder with regards to awards previously made to him.
- e) The previous and existing compliance by the Bidder with laws and regulations relative to procurement.
- f) The sufficiency of the financial resources and ability of the Bidder to perform.
- g) The ability of the bidder to provide future maintenance and services for the subject of the award.
- h) The compliance with all of the conditions to the Solicitation.

17. **TIE BIDS:** If the bids are for the same unit price or total amount in the whole or in part, the Chief Procurement Officer will determine award based on 2 GAR, Div. 4, § 3109(o) (2) or to reject all such bids.

18. **BRAND NAMES:** Any reference in the Solicitation to manufacturer's Brand Names and number is due to lack of a satisfactory specification of commodity description. Such preference is intended to be descriptive, but not restrictive and for the sole purpose of indicating to prospective bidders a description of the article or services that will be satisfactory. Bids on comparable items will be considered provided the bidder clearly states in his bid the exact articles he is offering and how it differs from the original specification.

19. **CONTRACT AWARD:** In accordance with 5 GCA § 5211(g) and 2 GARR § 3109(n), after bids are publicly opened, an award will be made with reasonable promptness by written notice to the lowest responsible and responsive bidder whose bid meets the requirements and criteria set forth in the Invitation for Bids. The award will be made by

- Purchase Order
- Standard Form Contract

20. **DESCRIPTIVE LITERATURE:** Descriptive literature(s) as specified in this solicitation must be furnished as a part of the bid and must be received at the date and time set for the opening Bids. The literature furnished must clearly identify the item(s) in the Bid. The descriptive literature is required to establish for the purpose of evaluation and award details of the product(s) the bidder proposes to furnish including design, materials, components, performance characteristics, methods of manufacture, construction, assembly or other characteristics which are considered appropriate. Rejection of the Bid will be required if the descriptive literature(s) do not show that the product(s) offered conform(s) to the specifications and other requirements of this solicitation. Failure to furnish the descriptive literature(s) by the time specified in the Solicitation will require rejection of the bid.

21. **SAMPLES:** Sample(s) of the item(s) specified in this solicitation must be furnished as a part of the bid and must be received at the date and time set for opening Bids. The sample(s) should represent exactly what the bidder proposes to furnish and will be used to determine if the item(s) offered complies with the specifications. Rejection of the Bid will be required if the sample(s) do not show that the product(s) offered conform(s) to the specifications and other requirements of this solicitation. Failure to furnish the sample(s) by the time specified in the Solicitation will require rejection of the Bid.

22. **LABORATORY TEST:** Successful bidder is required to accompany delivery of his good with a Laboratory Test Report indicating that the product he is furnishing the Government meets with the specifications. This report is on the bidder's account and must be from a certified Testing Association.

23. **AWARD, CANCELLATION, & REJECTION:** Award shall be made to the lowest responsible bidder, whose bid is determined to be the most advantageous to the Government, taking into consideration the evaluation factors set forth in this solicitation. No other factors or criteria shall be used in the evaluation. The right is reserved as the interest of the Government may require to waive any minor irregularity in bid received. The Guam Solid Waste Authority shall have the authority to award, cancel, or reject bids, in whole or in part for any one or more items if he determines it is in the public interest. In case of an error in the extension of prices, unit price will govern. It is the policy of the Government to award contracts to qualified local bidders. The Government reserves the right to increase or decrease the quantity of the items for award and make additional awards for the same type of items and the vendor agrees to such modifications and additional awards based on the bid prices for a period of thirty (30) days after original award. No award shall be made under this solicitation which shall require advance payment or irrevocable letter of credit from the government (GPR Section 3-202.14.1)

24. **MARKING:** Each outside container shall be marked with the Purchase Order number, item number, brief item description and quantity. Letter marking shall not be less than ¾" in height.

25. **SCHEDULE FOR DELIVERY:** Successful bidder shall notify the Guam Solid Waste Authority, Telephone No. 647-4312 at least twenty-four (24) hours before delivery of any item under this solicitation.

26. **BILL OF SALE:** Successful supplier shall render Bills of Sale for each item delivered under this contract. Failure to comply with this requirement will result in rejection of delivery. The Bill of Sale must accompany the items delivered but will not be considered as an invoice for payment. Supplier shall bill the Government in accordance with billing instructions as indicated on the Purchase Order.

27. **MANUFACTURER'S CERTIFICATE:** Successful bidder is required, upon delivery of any item under this solicitation, to furnish a certificate from the manufacturer indicating that the goods meet the specifications. Failure to comply with this request will result in rejection of delivery or payment. Supplier shall bill the Government in accordance with billing instructions as indicated on the Purchase Order.

28. **INSPECTION:** All supplies, materials, equipment, or services delivered under this contract shall be subject to the inspection and/or test conducted by the Government at destination. If in any case the supplies, materials, equipment, or services are found to be

defective in material, workmanship, performance, or otherwise do not conform with the specifications, the Government shall have the right to reject the items or require that they be corrected. The number of days required for correction will be determined by the Government.

29. **MOTOR VEHICLE SAFETY REQUIREMENTS:** The Government will only consider Bids on motor vehicles which comply with the requirements of the National Traffic and Motor Vehicle safety Act of 1966 (Public Law 89-563) and Clean Air Act as amended (Public Law 88-206), that are applicable to Guam. Bidders shall state if the equipment offered comply with these aforementioned Federal Laws.

30. **SAFETY INSPECTIONS:** All motor vehicles delivered under this contract must pass the Government of Guam Vehicle Inspection before delivery at destination.

31. **GUARANTEE:**

a) **Guarantee of Vehicle Type of Equipment**

The successful bidder shall guarantee vehicular type of equipment offered against defective parts, workmanship, and performance, for a period of not less than one (1) year after date of receipt of equipment. Bidder shall also provide service to the equipment for at least one (1) year. Service to be provided shall include, but will not be limited to tune ups (change of spark plugs, contact points and condensers) and lubrication (change of engine and transmission oil). All parts and labor shall be at the expense of the bidder. All parts found defective and not caused by misuse, negligence or accident within the guarantee period shall be repaired, replaced, or adjusted within six (6) working days after notice from the Government and without cost to the Government. Vehicular type of equipment as used in this context shall include equipment used for transportation as differentiated from tractors, backhoes, etc.

b) **Guarantee of Other Type of Equipment:**

The successful bidder shall guarantee all other types of equipment offered, except those mentioned in 31a, above, against defective parts, workmanship, and performance for a period of not less than three (3) months after date of receipt of equipment. Bidder shall also provide service to the equipment for at least three (3) months. All parts found within that period shall be repaired or replaced by the Contractor without cost to the Government. Repairs, adjustments or replacements of defective parts shall be completed by the contractor within six (6) working days after notice from the Government.

(c) **Compliance with this Section is a condition of this Bid.**

32. **REPRESENTATION REGARDING ETHICS IN PUBLIC PROCUREMENT:** The bidder or contractor represents that it has not knowingly influenced and promises that will not knowingly influence a Government employee to breach any of the ethical standards and represents that it has not violated, is not violating, and promises that it will not violate the prohibition against gratuities and kickbacks set forth on Chapter 11 (Ethics in Public Contracting) of the Guam Procurement Act and in Chapter 11 of the Guam Procurement Regulations.

33. **REPRESENTATION REGARDING CONTINGENT FEES:** The contractor represents that it has not retained a person to solicit or secure a Government contract upon and agreement or understanding for a commission, percentage, brokerage, or contingent fee, except for retention of bona fide employees of bona fide established commercial selling agencies for the purpose of securing business (GPR Section 11-207).

34. **EQUAL EMPLOYMENT OPPORTUNITY:** Contractors shall not discriminate against any employee or applicant of employment because of race, color, religion, sex, or national origin. The contractor will take affirmative action to ensure that employees are treated equally during employment without regards to their race, color, religion, sex, or national origin.

35. **COMPLIANCE WITH LAWS:** Bidders awarded a contract under this Solicitation shall comply with the applicable standard, provisions, and stipulations of all pertinent Federal and/or local laws, rules, and regulations relative to the performance of this contract and the furnishing of goods.

36. **CHANGE ORDER:** Any order issued relative to awards made under this solicitation will be subject to and in accordance with the provisions of Section 6-101-03.1 of the Guam Procurement Regulations.

37. **STOP WORK ORDER:** Any stop work order issued relative to awards made under this solicitation will be subject to and in accordance with the provisions of Section 6-101-04.1 of the Guam Procurement Regulations.

38. **CANCELLATION OF INVITATION FOR BIDS OR REQUEST FOR PROPOSALS:** Any Invitation for Bid may be cancelled, or any or all bids or proposals may be rejected in whole or in part as may be specified in the solicitation, when it is in the best interests of the Territory in accordance with regulations promulgated by the Policy Office. The reasons therefor shall be made part of the contract file.

39. **TIME FOR COMPLETION:** It is hereby understood and mutually agreed by and between the contractor and the Government that the time for delivery to final destination or the timely performance of certain services is an essential condition of this contract. If the contractor refuses or fails to perform any of the provisions of this contract within the time specified in the Purchase Order (from the date Purchase Order is acknowledged by the vendor), then the contractor is in default. Defaults will be treated subject to and in accordance with the provisions of Section 6-101-08 of the Guam Procurement Regulations.

40. **JUSTIFICATION OF DELAY:** Bidders who are awarded contracts under this Solicitation, guarantee that the goods will be delivered to their destination or required services rendered within the time specified. If the bidder is not able to meet the specified delivery date, he is required to notify the Guam Solid Waste Authority of such delay. Notification shall be in writing and shall be received by the Guam Solid Waste Authority at least twenty-four (24) hours before the specified delivery date. Notification of delay shall include an explanation of the causes and reasons for the delay including statement(s) from supplier or shipping company causing the delay. The Government reserves the right to reject delay justification if, in the opinion of the Chief Procurement Officer, such justification is not adequate.

41. **SERVICE-DISABLED VETERAN OWNED BUSINESS PREFERENCE:** Bidding is subject to the policy in favor of Service-Disabled Veteran Owned Business as defined in 5 GCA sections 5011 and 5012.

42. **LIQUIDATED DAMAGES:** When the contractor is given notice of delay or nonperformance as specified in Paragraph 1 (Default) of the Termination for Default Clause of this contract and fails to cure in the time specified, the contractor shall be liable for

damages for delay in the amount of one-fourth of one percent (1%) of outstanding order per calendar day from date set for cure until either the territory reasonable obtains similar supplies or services if the contractor is terminated for default, or until the contractor provides the supplies or services if the contractor is not terminated for default. To the extent that the contractor's delay or non-performance is excused under Paragraph 15 (Excuse for Nonperformance or Delayed Performance) of the Termination for Default Clause of this contract, liquidated damages shall not be due the territory. The contractor remains liable for damages caused other than by delay. 2 GAR, Div. 4 §6101(d)

[x] 43. **PHYSICAL LIABILITY:** If it becomes necessary for the Vendor, either as principal, agent or employee, to enter upon the premises or property of the Government of Guam in order to construct, erect, inspect, make delivery or remove property hereunder, the Vendor hereby covenants and agrees to take, use, provide and make all proper, necessary and sufficient precautions, safeguards and protections against occurrence of any accidents, injuries or damages to any person or property during the progress of the work herein covered, and to be responsible for, and to indemnify and save harmless the Government of Guam from the payment of all sums of money by reason of all or any such accidents, injuries, or damages that may occur upon or about such work, and fines, penalties and loss incurred for or by reasons of the violations of any territorial ordinance, regulations, or the laws of Guam or the United States, while the work is in progress. Contractor will carry insurance to indemnify the Government of Guam against any claim for loss, damage or injury to property or persons arising out of the performance of the Contractor or its employees and agents of the services covered by the contract and the use, misuse or failure of any equipment used by the contractor or his employees or agents, and shall provide certificates of such insurance to the Government of Guam when required.

[x] 44. Contract will be cancelled if funds not appropriated or insufficient, and that government will timely inform contractor. 2 GAR, Div.4 §3121(e) (1) (C) and 2 GAR, Div. 4 §3121 (e)(1)(D).

[x] 45. **CONTACT FOR CONTRACT ADMINISTRATION:** If your firm receives a contract as a result of this Solicitation, Please designate a person whom we may contact for prompt administration.

Name: John Alexius Limtiaco Jr.

Title: President

Address: P.O. Box 10838
Tamuning, GU 96931

Telephone: 671-888-6270

SEALED BID SOLICITATION INSTRUCTIONS

1. **BID FORMS:** Each bidder shall be provided with two (2) sets of Solicitation forms. Additional copies may be provided upon request. Bidders requesting additional copies of said forms will be charged per page in accordance with Section 6114 of the Government Code of Guam. All payments for this purpose shall be by cash, certified check or money order and shall be made payable to the Guam Solid Waste Authority.
2. **PREPARATIONS OF BIDS:**
 - a. Bidders are required to examine the drawings, specifications, schedule, and all instructions. Failure to do so will be at bidder's risk.
 - b. Each bidder shall furnish the information required by the Solicitation. The bidder shall sign the solicitation and print or type his name on the Schedule. Erasures or other changes must be initialed by the person signing the bid. Bids signed by an agent are to be accompanied by evidence of this authority unless such evidence has been previously furnished to the issuing office.
 - c. Unit price for each unit offered shall be shown and such price shall include packing unless otherwise specified. A total shall be entered in the amount column of the Schedule for each item offered. In case of discrepancies between a unit price and extended price, the unit price will be presumed to be correct.
 - d. Bids for supplies or services other than those specified will not be considered. Time, if stated as a number of days, means calendar days and will include Saturdays, Sundays, and holidays beginning the day after the issuance of a Notice to Proceed. Time stated ending on Saturday, Sunday or Government of Guam legal holiday will end at the close of the next business day.
 - e. No Entitlement to Preparation Costs – the bidder expressly waives any right it may have against the government for any expenses incurred in connection with the preparation of its bid.
3. **EXPLANATION TO BIDDERS:** Any explanation desired by a bidder regarding the meaning or interpretation of the Solicitation, drawings, specifications, etc., must be submitted in writing and with sufficient time allowed for a written reply to reach all bidders before the submission of their bids. Oral explanations or instructions given before the award of the contract will not be binding. Any information given to a prospective bidder concerning a Solicitation will be furnished to all prospective bidders in writing as an amendment to the Solicitation if such information would be prejudicial to uninformed bidders.
4. **ACKNOWLEDGEMENT OF AMENDMENTS TO SOLICITATIONS:** Receipt of an amendment to a Solicitation by a bidder must be acknowledged by signing an acknowledgement of receipt of the amendment. Such acknowledgement must be received prior to the hour and date specified for receipt of bids.
5. **SUBMISSION OF BIDS:**
 - a. Bids and modifications thereof shall be enclosed in sealed envelopes and addressed to the office specified in the Solicitation. The bidder shall show the hour and date specified in the Solicitation for receipt, the Solicitation number, and the name and address of the bidder on the face of the envelope.
 - b. Electronic bids will not be considered unless authorized by the Solicitation. However, bids may be modified or withdrawn by written or electronic notice, provided such notice is received prior to the hour and date specified for receipt (see paragraph 6 of these instructions).
 - c. Samples of items, when required, must be submitted within the time specified, unless otherwise specified by the Government, at no expense to the Government. If not destroyed by testing, samples will be returned at bidder's request and expense, unless otherwise specified by the Solicitation.
 - d. Samples or descriptive literature should not be submitted unless it is required by this solicitation. Regardless of any attempt by a bidder to condition the bid, unsolicited samples or descriptive literature will not be examined or tested at the bidder's risk, and will not be deemed to vary any of the provisions of this Solicitation.
6. **FAILURE TO SUBMIT BID:** If no bid is to be submitted, do not return the solicitation documents unless otherwise specified. A letter or postcard shall be sent to the issuing office advising whether future Solicitations for the type of supplies or services covered by this Solicitation are desired.
7. **LATE BID, LATE WITHDRAWALS, AND LATE MODIFICATIONS:**
 - a. Definition: Any bid received after the time and date set for receipt of bids is late. Any withdrawal or modification of a bid received after the time and date set for opening of bids at the place designated for opening is late (Guam Procurement Regulations Section 3-202)
 - b. Treatment: No late bid, late modification, or late withdrawal will be considered unless received before contract award, and the bid, modification, or withdrawal would have been timely but for the action or inaction of territorial personnel directly serving the procurement activity.
9. **GOVERNMENT FURNISHED PROPERTY:** No material, labor or facilities will be furnished by the Government unless otherwise provided for in the Solicitation.
10. **CANCELLATION OR REVISION OF BID:** This IFB may be canceled, or any and all bids may be rejected in whole or in part as may be pursuant to GAR § 3115, when it is in the best interest of the Government. Additionally, in accordance with GAR § 9105, if prior to award it is determined that a solicitation or proposed award of a contract is in violation of the law, then the solicitation or proposed award shall be canceled or revised to comply with the law. The reasons therefore shall be made part of the contract file.
11. **REJECTION OF BIDS:** Any bidder submitted in response to this IFB may be rejected in whole or in part with it is in the best interest of the Government, in accordance with GAR § 3115(e). Reasons for rejecting bids include but are not limited to: (1) The business that submitted the bid is non-responsive as determined under GAR § 3116; (2) The bid ultimately fails to meet the announced requirements of the Government in some material respect; or (3) The bid price is clearly unreasonable. Upon request, successful bidders shall be advised of the reasons for rejection.

When bids are rejected, or a solicitation canceled after bids are received, the bids which have been opened shall be retained in the procurement file, or if unopened, returned to the bidders upon request, or otherwise disposed of pursuant to GAR § 3115(g).

- 12. TERMINATION OF CONTRACT: 1. TERMINATION OF CONVENIENCE PURSUANT TO GAR § 6101(10)**
- (a) **Termination:** The Government, when the interest of the Government so requires, may terminate this contract in whole or in part, for the Convenience of the Government. The Purchasing Agency shall give written notice of the termination to the contractor specifying the part of the contract terminated when termination becomes effective.
 - (b) **Contractor's Obligations:** The contractor shall incur no further obligations in connection with the terminated work and on the date set in the notice of termination the contractor will stop work to the extent specified.
 - (c) **Condition of Termination:** Notwithstanding the foregoing, the cessation of services for people requiring services shall be contingent upon the Government obtaining a substitute provider for the services and the contractor shall cooperate by taking all reasonable and necessary steps to ensure that services are not interrupted and transferred to the succeeding provider. The contractor shall issue a written memorandum detailing the status of the contractor's ongoing services initiating termination or any fault of either party.
- 13. SELLER'S INVOICES:** Invoices shall be prepared and submitted in quadruplicate (one copy shall be marked "original") unless otherwise specified. Invoices shall be "certified true and correct" and shall contain the following information: Contract and order number (if any), item numbers, description of supplies or services, sizes, quantities, unit prices, and extended total. Bill of lading number and weight of shipment will be shown for shipments made on Government bills of lading.
- 14. RECEIPT, OPENING AND RECORDING OF BIDS:** Bids and modifications shall be publicly opened in the presence of one or more witnesses, at the time, date, and place designated in the Invitation for Bids. The name of each bidder, the bid price, and such other information as is deemed appropriate by the Procurement Officer, shall be read aloud and recorded, or otherwise made available. The names and addresses of required witnesses shall be recorded at the opening. The opened bids shall be available for public inspection except to the extent the bidder designates trade secrets or other proprietary data to be confidential as set forth in accordance with Section 12, below. Material so designated shall accompany the bid and shall be readily separable from the bid in order to facilitate public inspection of the non-confidential portion of the bid. Prices, makes and models or catalogue numbers of the items offered, deliveries, and terms of payment shall be publicly available at the time of bid opening regardless of any designation to the contrary (Guam Procurement Regulations Section 3-202.12.2).
- 15. CONFIDENTIAL DATA:** The Procurement Officer shall examine the bids to determine the validity of any requests for nondisclosure of trade secrets and other proprietary data.
- 16. PROHIBITION AGAINST GRATUITIES AND KICKBACKS:** With respect to this procurement and any other contract that bidder may have or wish to enter into with the Government, the bidder represents that he/she has not violated, is not violating, and promises that he will not violate the prohibition against gratuities and kickbacks set forth in the Guam Procurement Regulations – GAR § 11170(e)
- 17. STATEMENT OF QUALIFICATIONS** The ability capacity and skill of the Bidders to perform; Whether the bidder can perform promptly or within the specified time; The quality of performance of the Bidder with regards to awards previously made to him; The sufficiency of the financial resources and ability of the bidders to perform; And the compliance with all of the conditions to the solicitation.
- 18. WAGE AND BENEFIT COMPLIANCE-CONTRACTORS PROVIDING SERVICES:**
- (a) Contractor with regard to all person its employs whose purpose in whole or in part is the direct delivery of services contracted for with the Government of Guam in this procurement, shall pay such employees in accordance with the Wage Determination for Guam and the Northern Marianas Islands issued and promulgated by the U.S. Department of Labor for such labor as is employed in the direct deliverance of deliverables to the government of Guam. 5 GCA § 5801 Contractor shall be responsible for flowing down this obligation to its subcontractors.
 - (b) The Wage Determination most recently issued by the U.S. Department of Labor at the time this Agreement was awarded to Contractor shall be used to determine wages and benefits which shall be paid to employees pursuant to this clause. 5 GCA § 5801
 - (c) Should any contract contain a renewal clause, then at the time of renewal adjustments there shall be stipulations contained in that contract for applying the Wage Determination, so that the Wage Determination promulgated by the U.S. Department of Labor on a date most recent to the renewal date shall apply. 5 GCA § 5801
 - (d) In addition to the Wage Determination detailed above, health and similar benefits for employees having a minimum value as detailed in the wage Determination issued and promulgated by the U.S. Department of labor shall apply. Contractor shall pay a minimum of ten (10) paid holidays per annum per employee. 5 GCA § 5802
 - (e) Any violation of Contractor or its subcontractors obligations of this section shall be investigated by the Guam Department of Labor and may include a monetary penalty assessment by the Guam Department of Labor of no less that One Hundred Dollars (\$100.00) per day, and no more than One Thousand Dollars (\$1,000.00) per day, until such time as a violation has been corrected, as well as the payment of all black wages and benefits due. 5 GCA § 5803
 - (f) In addition to any and all other breach of contract actions the Government of Guam may have under this procurement, in the event there is a violation in the process set forth in subsection (e) above, Contractor may be placed on probationary status by the Chief Procurement Officer of the General Service Agency, or its successor, for a period of one (1) year.
During the probationary status, a Contractor shall not be awarded any contract by any instrumentality of the Government of Guam. A Contractor who has been on probationary status, or has been assessed a monetary

penalty pursuant to 5 GCA Article 13 Title 5 may appeal such penalty of probationary status to the Superior Court of Guam. 5 GCA § 5804

- (g) Contractor along with all proposed offerors and submitter under this procurement were required to submit a Declaration of Compliance with Wage Determination laws as part of this procurement with a copy of the most recent Wage Determination for Guam and the Northern Marianas Islands issued and promulgated by the U.S. Department of Labor. 5 GCA § 5805
 - (h) The applicable USDOL Wage Determination Rate Revision (as defined by subsections (b) and (c) is to this Agreement. Contractor agrees to provide upon written request by the Government of Guam written certification of its compliance with its obligations as part of each invoice, along with the names of any employees, their positions, and detailed wage and benefits paid in keeping with this section. Additionally upon request by Government of Guam the Contractor shall submit source documents as to those individuals provide direct services in part or whole under this Agreement and its payments to them of such wages and benefits.
19. **ETHICAL STANDARDS:** With respect to this procurement and any other contract that the Contractor may have, or wish to enter into, with any Government of Guam agency, the Contractor represents that it has not knowingly influenced, and promises that it will not knowingly influence, any government employee to breach any of the ethical standards set forth in the Guam Procurement Law and in any of the Guam Procurement Regulations. – GAR § 11103 (b).
20. **PROHIBITION AGAINST CONTINGENT FEES:** The Contractor represents that he has not retained any person or agency upon an Agreement or Understanding for a percentage, commission, brokerage, or other contingent arrangement, except for retention of bona fide employees or bona fide established commercial selling agencies, to solicit or secure this Agreement or any contract with the government of Guam or its agencies. GAR § 11108(f)
21. **CONTRACTOR'S WARRANTY AS TO EMPLOYEES AND SEX OFFENSES. Reference 5 GCA 5253(b):** : Contractor warrants that no person providing services on behalf of the Contractor has been convicted of a sex offense under the provisions of Chapter 25 of Title 9 of GCA or an offense as defined in Article 2 of Chapter 28, Title 9 GCA, or an offense in another jurisdiction with, at a minimum, the same elements as such offenses, or who is listed on the Sex Offender Registry.
- Contractor warrants that if any person providing services on behalf of Contractor is convicted of a sex offense under the provisions of Chapter 25 of Title 9 GCA, or an offense as defined in Article 2 of Chapter 28, Title 9 GCA, or an offense in another jurisdiction with, at a minimum, the same elements as such offenses, or who is listed on the Sex Offender Registry, that such person will be immediately removed from working at said agency and that the administrator of said agency be informed of such within twenty-four (24) hours of such conviction. Any contractor found in violation of this section, after notice from the Government of Guam, after notice from the contracting authority of such violation, shall within twenty-four (24) hours, take corrective action and shall report such action to the contracting authority. Failure to take corrective action with the stipulated period may result in the temporary suspension of the contract at the discretion of the Government of Guam.
22. **POLICY IN FAVOR OF SERVICE-DISABLED VETERAN OWNED BUSINESSES:** P.L. 31-115 (September 20, 2011) 5 GCA § 5011 and § 5012 In the procurement of any supply or service, (except for professional services), if such supply or service is offered by a Service Disabled Veteran Owned Business "SDVOB", as defined in 5 GCA § 5012, that is at least fifty one percent (51%) owned by service-disabled veteran(s), and if the supply or service is available within the period that is required for the procurement, and the price for the supply or service does not exceed one hundred five percent (105%) of the lowest bidder price, a preference shall be given to that SDVOB by the Government of Guam, and the supply or service shall be purchased from said SDVOB. This shall be in addition to any other procurement benefit the SDVOB may qualify for under Guam law. A business concern is a qualified SDVOB if: (a) the business concern is licensed to do business on 7Guam; (b) the business concern maintains its headquarters on Guam; (c) the business concern is at least fifty-one (51%) owned by a service-disabled veteran(s) who served in the active U.S. military service, was discharged or released under honorable conditions and whose disability is service-connected as demonstrated by a DD214, and certified by an award letter from the U.S. Department of Veterans Affairs; the DD214 and Disability award letter from U.S. Department of Veterans Affairs are submitted to the Government of Guam procuring agency for every service offered; and the service disabled veteran(s) owner(s) of the business concern has filed individual tax returns on Guam for a period of at least three (3) consecutive years.
23. **CERTIFICATION OF INDEPENDENT PRICE DETERMINATION:** The undersigned Bidder certifies that the bid price submitted was independently arrived at without collusion — GAR § 3126
24. **LICENSING OR CERTIFICATE(S) OF EXEMPTIONS:** Bidders are cautioned that the Government will not consider for award any offer submitted by a bidder who cannot comply with the Guam Licensing Law. Specific information on license or exemptions may be obtained from the Director of Revenue and Taxation.
25. **EQUAL EMPLOYMENT OPPORTUNITY:** Bidder shall not discriminate against any employee or applicant for employment because of race, color, religion, sex, or national origin. The contractor will take affirmative action to ensure that employees are treated equally during employment without regards to their race, color, religion, sex, or national origin.
26. **DISCLOSURES OF MAJOR SHAREHOLDERS:** (5 GCA § 5233) As a condition of submitted a bid, any partnership, sole proprietorship or corporation doing business with the Government of Guam shall submit an affidavit executed under oath that lists the name and address of any person who has held more than ten percent (10%) of the outstanding interest or shares in said month period immediately preceding submission of proposal.



GUAM SOLID WASTE AUTHORITY

LOURDES A. LEON GUERRERO
Governor of Guam

JOSHUA F. TENORIO
Lt. Governor of Guam

IRVIN L. SLIKE
General Manager



IFB TIMETABLE:

The following IFB timetable should be used as a working guide for planning purposes. GSWA reserves the right to adjust this timetable as required during the course of the IFB process.

Registration Form for GSWA IFB Packet will be available on the Guam Solid Waste Authority website at www.gswa.guam.gov .	Friday, November 3, 2023
---	--------------------------

Deadline for Receipt of Written Questions must be e-mailed to the Guam Solid Waste Authority at procurement@gswa.guam.gov , ATTN: General Manager	Thursday, November 9, 2023 on or before 5:00PM Chamorro Standard Time
--	---

Deadline for Answers to Written Questions will be e-mailed to Offerors who registered.	Wednesday, November 14, 2023 on or before 5:00PM Chamorro Standard Time
--	---

Bid Due Date & Bid Opening at the Guam Solid Waste Authority: Administration Office, GSWA Bldg., 2 nd Floor, 546 N. Marine Corps Dr., Tamuning, Guam	Monday, November 20, 2023 at 1:00PM Chamorro Standard Time
---	--



GUAM SOLID WASTE AUTHORITY

LOURDES A. LEON GUERRERO
Governor of Guam

JOSHUA F. TENORIO
Lt. Governor of Guam

IRVIN L. SLIKE
General Manager



ITEM NO.	DESCRIPTION	QTY	UOM	UNIT PRICE	PRICE EXTENSION
1.0	Compact Wheel Loader w/ Attachments	1	EA	\$ 227,261.18	\$ 227,261.18

SPECIFICATIONS:

Indicate on each line of the technical specifications whether or not each item complies with the specification or an exception is being taken. If additional space is required to fully explain bid exceptions, attach additional typed page(s) to the bid submittal indicating the section number and subsection that has the exception, and provide explanation.

	COMPLY / NON-COMPLIANCE
Engine: Gross HP at 2400 RPM: 73 HP minimum	Comply
Peak Torque at 1560 RPM: 206 foot lbs. minimum	Comply
Emissions: Compliant with EPA Final Tier 4/EU Stage V	Comply
Four cylinders	Comply
Powertrain: Hydrostatic with infinitely variable speed control over full range of operating speeds. 2 speed ranges, joystick mounted F-N-R, acceleration pedal.	Comply
Axes: Fixed, 100% differential, manually engaged front axle, fixed conventional differential rear axle or oscillating rear axle	Comply
Max rise and fall single wheel: 15 inches maximum, 14 inch minimum	Comply
Hydraulically activated, self-adjusting internal wet disc brakes and driveline drum brake	Comply
Cooling: Hydraulically driven, proportionally controlled fan or belt-driven fan	Comply
Articulation Angle: 30 degrees each direction	Comply
Cylinders: Heat treated chrome plated polished cylinder rods, hardened steel, replaceable bushings and pivot pins	Comply
Hydraulics: Main pump (loader and steering): 18 GPM standard, 29 GPM with high flow option.	Comply
Quick Coupling: Conforms with ISO 16028 quick coupling for all attachments	Comply
Electrical: Voltage: 12-volt or 24-volt electrical system	Comply
Battery: One (1) 24-volt or two (2) 12-volt	Comply
Battery capacity: One (1) 925 CCA or Two (2) 900 CCA	Comply
Cab: Seat: Air ride high back with head rest and dual lumbar support or mechanical suspension seat	Comply
Noise: Operator ear 70 dBA, Bystander 101 dBA	



GUAM SOLID WASTE AUTHORITY

LOURDES A. LEON GUERRERO
Governor of Guam

JOSHUA F. TENORIO
Lt. Governor of Guam

IRVIN L. SLIKE
General Manager



	COMPLY / NON-COMPLIANCE
Air conditioning	Comply
Steering: Dual tilt and telescoping steering column	Comply
Performance: Conforms with SAE J1040, SAE J231, ISO 3471 and ISO 3449 ROPS/FOPS	Comply
Operating Weight: ISO quick coupler and 1CY general purpose bucket / bolt on edge 12,250 lbs. minimum	Comply
1.4 CY multi-purpose bucket: 12,800 lbs. maximum	Comply
Wheelbase: 7 feet minimum	Comply
Dump clearance: 40-degree full height – 8 feet 3 inches	Comply
Reach: 40-degree full height – 32 inches	Comply
Fork height fully raised: 10 feet minimum	Comply
Fork tipping load straight: 7000 lb. maximum	Comply
Attachments: ISO quick coupling mechanism: Conforms with ISO 16028	Comply
One (1) additional 1.4 CY bucket with bolt on edge	Comply
One (1) Tink claw bucket model 520 or equal	Comply
One (1) 60-inch pick-up broom: 800 lb. minimum; 900 lb. max	Comply
One (1) Fork: 48 inches minimum	Comply
Equipment Warranty: The Bidder guarantees to the Purchaser that the equipment, upon delivery, will be brand new and will have been constructed using entirely new components. Furthermore, the Bidder assures that any new equipment provided shall be free from any defects in manufacturing workmanship and materials for a duration of 24 months or 2,000 hours, whichever occurs first, commencing from the date of equipment delivery. This warranty encompasses any necessary repairs or replacements without any additional cost to the Purchaser.	Comply
Miscellaneous Items: One (1) operator’s manual hardcopy	Comply
One (1) operator’s manual on CD	Comply
One (1) complete illustrated parts book	Comply
One (1) shop repair manual	Comply
One (1) warranty manual	Comply
Manufacturer’s training of GSWA crew (8 hours) & contracted mechanics (20 hours)	Comply
Online manual for parts, service & repair	Comply



GUAM SOLID WASTE AUTHORITY



LOURDES A. LEON GUERRERO
Governor of Guam

JOSHUA F. TENORIO
Lt. Governor of Guam

IRVIN L. SLIKE
General Manager

Delivered with a full tank of fuel

Comply

Note: The GSA Federal Contract will be considered along with its terms and conditions if offered.

Bidding On:

Manufacturer: John Deere

Year: 2024

Model: 244P

Place of Origin: USA

Date of Delivery: 200 Days ARO (Subject to force majeure)

Attachments:

- * Haugen HPB 60-Euro Broom
- *Rockland Multi-Purpose Bucket
- *Tink Claw Bucket C520

244 \ P

GSWA PROCUREMENT RECORD Page 427



JOHN DEERE

Compact Wheel Loader



244 P-TIER COMPACT WHEEL LOADER



RUN SMALL, DREAM BIG

Your workday is usually long, your tasks can take you into tight places, and you need a multipurpose machine to get everything done. Smaller do-it-all equipment that combines head-turning maneuverability, sure-footed stability, and comfortable capability with productive power, responsive travel speed, and ease of serviceability. Meet the 244 P-Tier Compact Wheel Loader, designed to include a wide range of reliable standard features and proven options that help you imagine the big results this highly adaptable multitasker can deliver for your operation.

FEATURES

Turn things around

Industry-exclusive Articulation Plus™ steering system combines 30 degrees of articulation with 10 additional degrees of rear-wheel steer. Reduced articulation angle design delivers tighter turns that are more stable, especially with large loads, than comparably sized loaders without Articulation Plus.

On the level

Loader arm and coupler design improves the lifting path to near parallel — for better load-carrying capability than previous models. This keeps the load more level from ground to truck-bed height and helps the operator focus on the task instead of on making manual adjustments.

Fast getaway

With a standard top speed of over 23 mph, the 244 P-Tier can make some pretty quick moves on and between jobsites.

Smooth moves

Load-sensing AutoShift powertrain technology eliminates productivity-interrupting manual shifts between gear ranges while providing smooth direction changes.

Control and command

Low-effort joystick controls boom and bucket, forward-neutral-reverse (F-N-R), and differential lock. Standard mini-joystick controls auxiliary hydraulic functions including optional high-flow. Adjustable-height monitor lets operators keep close watch on vital machine functions.

Enjoy the ride

Standard ride control cushions the boom during travel over rough and uneven terrain, reducing material spillage from the bucket and minimizing site cleanup.



**MORE
STABLE***

+



**MORE
MANEUVERABLE***

+



**MORE
CAPABLE***

*Compared to leading competitive articulation loaders of the same size.

Lighten up

In-cab lighting activates when the door is opened to illuminate machine entrances and exits. Optional LED front and rear work-lights brilliantly brighten early morning or after-daylight tasks.

Quick-change artist

Equip your 244 P-Tier with an ISO coupler to quickly and easily go from bucket to forks, for maximum lift capacity. Opt for the available John Deere quick-coupler to utilize a wide array of skid-steer-compatible attachments. High-flow electro-hydraulic-controlled auxiliary hydraulics are also available.

It's a lock

Optional throttle lock and creep control let operators set a slow ground speed while maintaining full engine power to an attachment. Now even easier to activate and adjust on the fly, these functions are perfect for work with snow blowers, cold planers, or material scrapers.

Get a grip

Manual low-speed 100-percent differential lock delivers the ground-gripping tractive effort needed to dive deep into the pile and help heap the bucket. Rimpull control manages power to the wheels, allowing the operator to select the optimal setting to reduce tire and driveline wear.

Keep your cool

Redesigned engine compartment and cooling package improve airflow and reduce the amount of debris entering the system compared to previous models. Access to all daily service checks and cooler cores is from ground level.

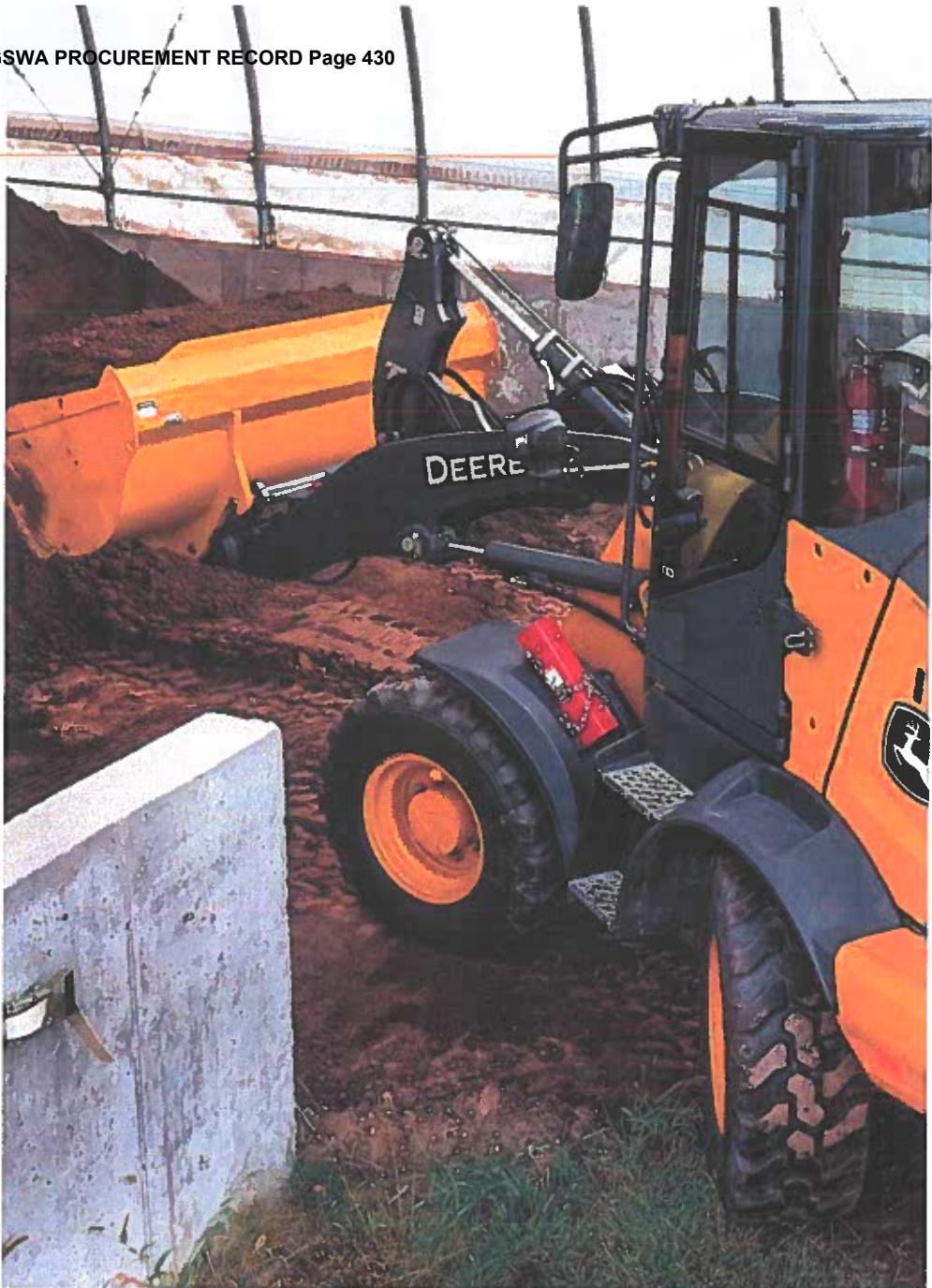

244 P-TIER COMPACT WHEEL LOADER



**OPTIONAL LED
FRONT & REAR WORKLIGHTS
ENHANCE VISIBILITY**

Business booster

John Deere attachments are a great way to expand the flexibility of your operation. With more than 100 models, they'll help you broaden your abilities, work smarter, and accomplish even more.

Here to back you up

Parts and service are always available at over 1,400 John Deere dealer locations throughout North America.



244 P-TIER WHEEL LOADER SPECIFICATIONS

While general information, pictures, and descriptions are provided, some illustrations and text may include product options and accessories NOT AVAILABLE in all regions, and in some countries products and accessories may require modifications or additions to ensure compliance with the local regulations of those countries.

Engine		244 P-TIER	
Manufacturer and Model	Yanmar 4TNV98CT	Gross Rated Power at 2,400 rpm (ISO 14396)	54 kW (73 hp)
Non-Road Emission Standard	EPA Final Tier 4/EU Stage V	Peak Torque at 1,560 rpm	280 Nm (206 lb.-ft.)
Cylinders	4	Engine Bore and Stroke	98 x 110 mm (3.89 x 4.33 in.)
Valves per Cylinder	4	Lubrication	Pressure system with full-flow spin-on filter
Displacement	3.3 L (203 cu. in.)	Aspiration	Turbocharged
Net Peak Power at 2,400 rpm (SAE J1349 / ISO 9249)	52 kW (71 hp)	Air Cleaner	Dual safety element dry type
Cooling			
Fan	Hydraulically driven, proportionally controlled		
Engine Coolant Rating	-37 deg. C (-34 deg. F)		
Powertrain			
Type	Hydrostatic (HST) with infinitely variable speed control over full range of operating speeds; 2 speed ranges; joystick-mounted F-N-R; acceleration pedal; HST inching pedal, which allows infinitely reduced travel speeds while maintaining full engine rpm and hydraulic flow		
2 Travel Speeds in Forward and Reverse (equipped with 365/70R18 tires)			
Gear 1	18 km/h (11.0 mph)		
Gear 2	38 km/h (23.5 mph)		
Axles	Fixed, 100% differential, manually engaged front axle; fixed, conventional differential rear axle		
Rear Axle Oscillation Versus Front Axle	16 deg. total, stop to stop		
Differentials	Manual (push-button) 100% locking front, conventional rear		
Maximum Rise and Fall, Single Wheel	370 mm (14.5 in.)		
Steering	Hydraulic power steering (SAE J1511); 30-deg. articulation left and right with mechanical-actuated rear-wheel steering		
Steering Wheel Turns, Stop to Stop	4¼ (2 left / 2¼ right)		
Articulation Angle	60-deg. arc (30 deg. each direction)		
Final Drive	Heavy-duty outboard planetary		
Brakes (SAE J1473 / ISO 3450)			
Service Brakes	Hydraulically actuated, self-adjusting internal wet-disc brake and driveline drum brake		
Parking Brake	Automatically spring-applied, hydraulically released, internal wet disc		
Hydraulics			
Main Pump (loader and steering)	Fixed-displacement gear pump; open-center system		
Standard	70 L/m (18 gpm)		
Total With High-Flow Option	109 L/m (29 gpm)		
Maximum Pressure at Couplings	23 000 kPa (3,335 psi)		
System Relief Pressure			
Loader	23 000 kPa (3,335 psi)		
Steering	18 000 kPa (2,611 psi)		
Controls	Pilot-operated, 3-function valve with single-lever control for boom and bucket, standard pin disconnect and 3rd-function proportional electrohydraulic (EH) auxiliary hydraulics		
Cylinders			
Type	Heat-treated, chrome-plated, polished cylinder rods; hardened steel (replaceable bushings) pivot pins		
Electrical			
Type	Electrical load center with blade-type multi-fused circuits		
Voltage	12 volt		
Number of Batteries	1		
Battery Capacity	925 CCA		
Alternator Rating	80 amp		
Lights (SAE 99)	Driving/front working lights (2), turn signals, flashers, and stop- and taillights		
Operator Station			
Noise Level			
Operator Ear (ISO 6396)	70 dBA		
Bystander (ISO 6395)	101 dBA		
Tires/Wheels			
Tires on Single-Piece Rims	<i>Tread Width*</i>	<i>Width Over Tires†</i>	<i>Change in Vertical Height</i>
365/70R18 Mitas EMO1 (standard)	1510 mm (4 ft. 11 in.)	1920 mm (6 ft. 4 in.)	0 mm (0 in.)
405/70R18 Firestone Duraforce (optional)	1510 mm (4 ft. 11 in.)	1960 mm (6 ft. 5 in.)	+23 mm (+0.9 in.)
400/70R20 Michelin XMCL (optional)	1510 mm (4 ft. 11 in.)	1960 mm (6 ft. 5 in.)	+44 mm (+1.7 in.)
400/70R20 Michelin Bibload (optional)	1510 mm (4 ft. 11 in.)	1950 mm (6 ft. 5 in.)	+38 mm (+0.9 in.)
400/70R20 Nokian Hakkapeliitta (optional)	1510 mm (4 ft. 11 in.)	1950 mm (6 ft. 5 in.)	+48 mm (+1.9 in.)
*Also see Q in Dimensions section on pages 7 and 9. / †Also see R in Dimensions section on pages 7 and 9.			
Serviceability			
Refill Capacities	Refill Capacities (continued)		
Cooling System (engine and radiator)	12.1 L (12.7 qt.)	Fuel Tank	90 L (23.8 gal.)
Differential and Planetary Axle		Hydraulic/HST Reservoir With Filter	66 L (17.4 gal.)
Front	5.2 L (5.5 qt.)	HST Motor Gearbox	1.7 L (1.8 qt.)
Rear	4.7 L (5.0 qt.)	Front/Rear Axle Planetary Hubs (each)	0.8 L (1.0 qt.)
Engine Oil With Filter	10 L (10.8 qt.)		

244 P-TIER WHEEL LOADER SPECIFICATIONS

244

P

While general information, pictures, and descriptions are provided, some illustrations and text may include product options and accessories NOT AVAILABLE in all regions, and in some countries products and accessories may require modifications or additions to ensure compliance with the local regulations of those countries

Operating Weights

244 P-TIER

With standard equipment, 365/70R18 tires, standard counterweight, cab, 79-kg (175 lb.) operator, and full fuel tank

ISO Quick-Coupler	
With 0.8-m ³ (1.0 cu. yd.) General-Purpose (GP) Bucket With Bolt-On Edge	5560 kg (12,258 lb.)
With 1.1-m ³ (1.4 cu. yd.) GP Bucket With Bolt-On Edge	5680 kg (12,522 lb.)
With Fork	5455 kg (12,026 lb.)
Quik-Tatch™ Quick-Coupler	
With 0.8-m ³ (1.0 cu. yd.) GP Bucket With Bolt-On Edge	5690 kg (12,544 lb.)
With 1.1-m ³ (1.4 cu. yd.) GP Bucket With Bolt-On Edge	5800 kg (12,787 lb.)

Quik-Tatch Quick-Coupler (continued)	
With Fork	5500 kg (12,125 lb.)
Optional Components	
ISO Quick-Coupler	
0.8-m ³ (1.0 cu. yd.) Bucket With Bolt-On Edge	337 kg (743 lb.)
1.1-m ³ (1.4 cu. yd.) Bucket With Bolt-On Edge	457 kg (1,008 lb.)
Fork and Tines	232 kg (511 lb.)
Quik-Tatch Quick-Coupler	
0.8-m ³ (1.0 cu. yd.) Bucket With Bolt-On Edge	467 kg (1,030 lb.)
1.1-m ³ (1.4 cu. yd.) Bucket With Bolt-On Edge	577 kg (1,272 lb.)
Fork and Tines	277 kg (611 lb.)

Dimensions and Specifications With ISO Quick-Coupler and Bucket

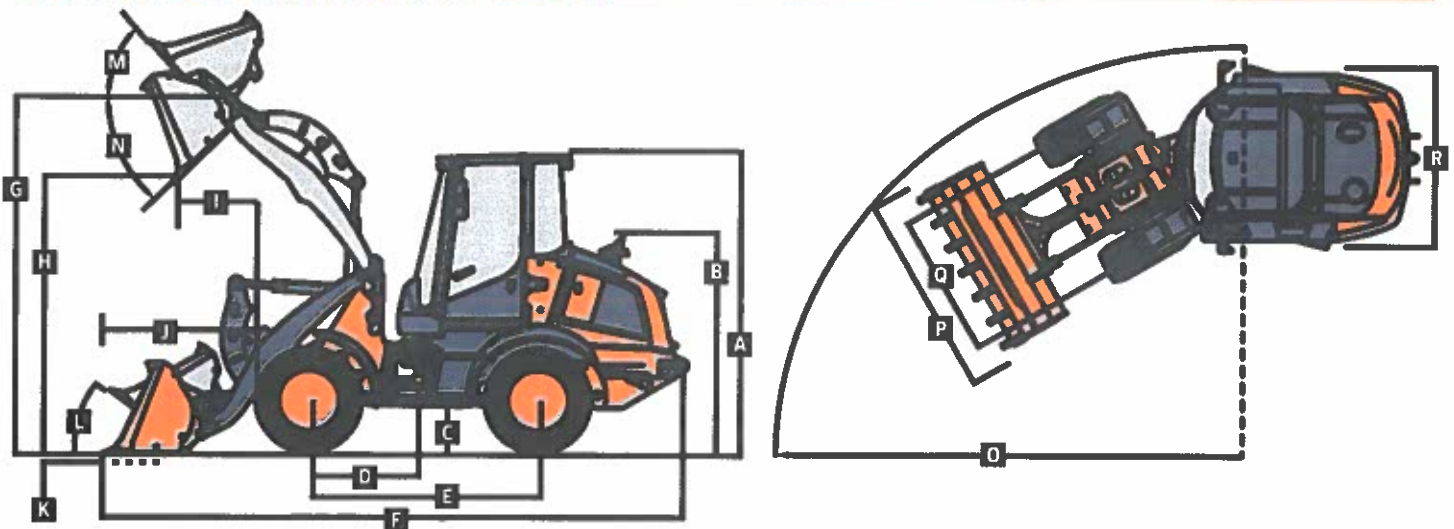

244 P-TIER Z-BAR LOADER WITH ISO QUICK-COUPLER AND BUCKET
Standard Linkage

Dimensions With ISO Quick-Coupler and General-Purpose (GP) Bucket With Bolt-On Edge

- A Height to Top of Cab
- B Height to Top of Exhaust
- C Ground Clearance
- D Length From Centerline to Front Axle
- E Wheelbase
- F Overall Length, Bucket on Ground
- G Height to Hinge Pin, Fully Raised
- H Dump Clearance, 40-deg. Full Height
- I Reach, 40-deg. Dump, Full Height
- J Maximum Dump Reach, 42-deg. Dump
- K Maximum Digging Depth
- L Maximum Rollback at Ground Level
- M Maximum Rollback at Full Height
- N Bucket Dump at Full Height
- O Turning Circle Radius Over Outside of Bucket Edge
- P Bucket Width
- Q Tread Width (standard)⁶
- R Width Over Tires (standard)⁶

	Standard Linkage	Standard Linkage
	0.8-m ³ (1.0 cu. yd.)	1.1-m ³ (1.4 cu. yd.)
A	2.75 m (9 ft. 0 in.)	2.75 m (9 ft. 0 in.)
B	1.98 m (6 ft. 6 in.)	1.98 m (6 ft. 6 in.)
C	285 mm (11 in.)	285 mm (11 in.)
D	750 mm (30 in.)	750 mm (30 in.)
E	2.15 m (7 ft. 1 in.)	2.15 m (7 ft. 1 in.)
F	5.41 m (17 ft. 9 in.)	5.47 m (17 ft. 11 in.)
G	3.22 m (10 ft. 7 in.)	3.22 m (10 ft. 7 in.)
H	2.52 m (8 ft. 3 in.)	2.48 m (8 ft. 2 in.)
I	810 mm (32 in.)	860 mm (34 in.)
J	1.52 m (5 ft. 0 in.)	1.56 m (5 ft. 1 in.)
K	95 mm (4 in.)	95 mm (4 in.)
L	39 deg.	39 deg.
M	55 deg.	55 deg.
N	42 deg.	42 deg.
O	3.82 m (12 ft. 6 in.)	3.97 m (13 ft. 0 in.)
P	1.90 m (6 ft. 3 in.)	2.20 m (7 ft. 3 in.)
Q	1510 mm (4 ft. 11 in.)	1510 mm (4 ft. 11 in.)
R	1920 mm (6 ft. 4 in.)	1920 mm (6 ft. 4 in.)
	7.64 m (25 ft. 1 in.)	7.94 m (26 ft. 1 in.)

Loader Clearance Circle, Bucket Carry Position

⁶Also see Tires/Wheels section on page 6.

Specifications With ISO Quick-Coupler and Bucket

Capacity, Heaped (SAE)	0.8 m ³ (1.0 cu. yd.)	1.1 m ³ (1.4 cu. yd.)
Capacity, Struck (SAE)	0.66 m ³ (0.86 cu. yd.)	0.9 m ³ (1.18 cu. yd.)
Breakout Force (SAE J732C)	4895 kg (10,792 lb.)	4410 kg (9,722 lb.)
Tipping Load, Straight	4060 kg (8,951 lb.)	3930 kg (8,664 lb.)
Tipping Load, Full Turn (SAE)	3700 kg (8,157 lb.)	3580 kg (7,893 lb.)
Rated Operating Load, 50% of Full-Turn Tipping Load (conforms to ISO 14397-1)*	1850 kg (4,079 lb.)	1790 kg (3,946 lb.)

*Rated operating capacity based on Deere attachments only.

Dimensions and Specifications With ISO Quick-Coupler and Fork

244 P-TIER

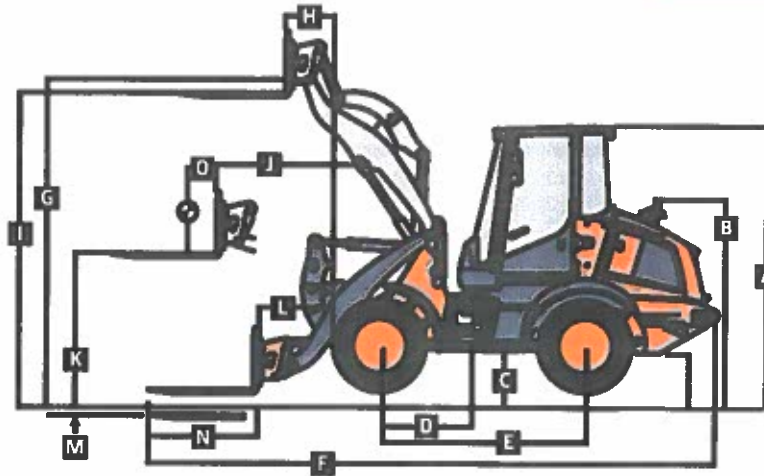

244 P-TIER Z-BAR LOADER WITH ISO QUICK-COUPLER AND FORK

Dimensions With ISO Quick-Coupler and Fork

- A Height to Top of Cab
- B Height to Top of Exhaust
- C Ground Clearance
- D Length From Centerline to Front Axle
- E Wheelbase
- F Overall Length, Forks on Ground
- G Height to Hinge Pin, Fully Raised
- H Reach, Fully Raised
- I Fork Height, Fully Raised
- J Maximum Reach, Fork Level
- K Fork Height, Maximum Reach
- L Reach, Ground Level
- M Depth Below Ground
- N Tine Length
- O Load Position, 50% Tine Length

Specifications With ISO Quick-Coupler and Fork

- Tipping Load, Straight 3215 kg (7,088 lb.)
- Tipping Load, Full Turn (SAE) 2930 kg (6,460 lb.)
- Rated Operating Load, 50% Full-Turn Tipping Load (conforms to SAE J1197 / ISO 14397-1)* 1465 kg (3,230 lb.)[†]
- Rated Operating Load, Rough Terrain, 60% Full-Turn Tipping Load (conforms to EN474-3)* 1820 kg (4,012 lb.)[†]
- Rated Operating Load, Firm and Level Ground, 80% Full-Turn Tipping Load (conforms to EN474-3)* 2300 kg (5,071 lb.)[†]

*Rated operating capacity based on Deere attachments only. / [†]Payload on forks is limited by tilt cylinder.

Standard Linkage

- 1.20-m (48 in.) tine length
- 2.75 m (9 ft. 0 in.)
- 1.98 m (6 ft. 6 in.)
- 285 mm (11 in.)
- 750 mm (30 in.)
- 2.15 m (7 ft. 1 in.)
- 5.99 m (19 ft. 8 in.)
- 3.22 m (10 ft. 7 in.)
- 525 mm (21 in.)
- 3.05 m (10 ft. 0 in.)
- 1.24 m (4 ft. 1 in.)
- 1.45 m (4 ft. 9 in.)
- 740 mm (29 in.)
- 50 mm (2 in.)
- 1.20 m (48 in.)
- 600 mm (24 in.)

As measured with fork level, centered on tine

While general information, pictures, and descriptions are provided, some illustrations and text may include product options and accessories NOT AVAILABLE in all regions, and in some countries products and accessories may require modifications or additions to ensure compliance with the local regulations of those countries.

Dimensions and Specifications With Quik-Tatch™ Coupler and Bucket

244 P-TIER

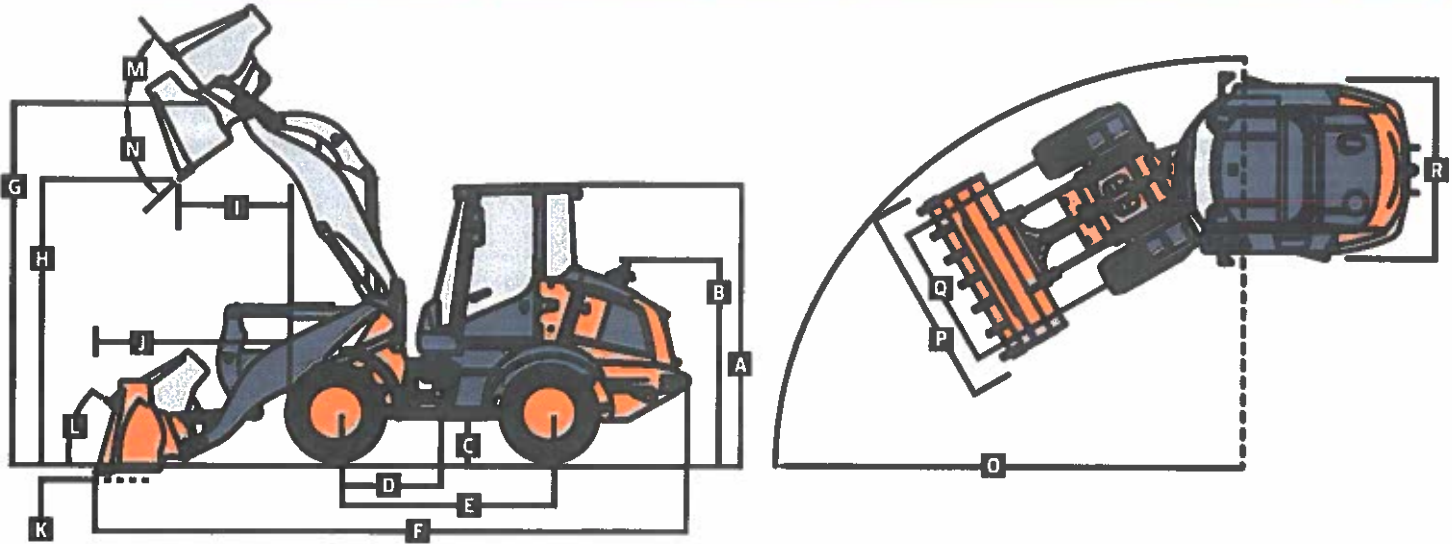

244 P-TIER Z-BAR LOADER WITH QUIK-TATCH COUPLER AND BUCKET

Dimensions With Quik-Tatch Coupler and General-Purpose (GP) Bucket With Bolt-On Edge

- A Height to Top of Cab
- B Height to Top of Exhaust
- C Ground Clearance
- D Length From Centerline to Front Axle
- E Wheelbase
- F Overall Length, Bucket on Ground
- G Height to Hinge Pin, Fully Raised
- H Dump Clearance, 40-deg. Full Height
- I Reach, 40-deg. Dump, Full Height
- J Maximum Dump Reach, 42-deg. Dump
- K Maximum Digging Depth
- L Maximum Rollback at Ground Level
- M Maximum Rollback at Full Height
- N Bucket Dump at Full Height
- O Turning Circle Radius Over Outside of Bucket Edge
- P Bucket Width
- Q Tread Width (standard)[§]
- R Width Over Tires (standard)[§]

Loader Clearance Circle, Bucket Carry Position

[§]Also see *Tires/Wheels* section on page 6.

Specifications With Quik-Tatch Coupler and Bucket

- Capacity, Heaped (SAE)
- Capacity, Struck (SAE)
- Breakout Force (SAE J732C)
- Tipping Load, Straight
- Tipping Load, Full Turn (SAE)
- Rated Operating Load, 50% of Full-Turn Tipping Load (conforms to ISO 14397-1)*

*Rated operating capacity based on Deere attachments only.

Standard Linkage

- 0.8-m³ (1.0 cu. yd.)
- 2.75 m (9 ft. 0 in.)
- 1.98 m (6 ft. 6 in.)
- 285 mm (11 in.)
- 750 mm (30 in.)
- 2.15 m (7 ft. 1 in.)
- 5.61 m (18 ft. 5 in.)
- 3.22 m (10 ft. 7 in.)
- 2.52 m (8 ft. 3 in.)
- 1.09 m (3 ft. 7 in.)
- 1.71 m (5 ft. 7 in.)
- 55 mm (2 in.)
- 50 deg.
- 58 deg.
- 40 deg.
- 3.87 m (12 ft. 8 in.)
- 1.90 m (6 ft. 3 in.)
- 1510 mm (4 ft. 11 in.)
- 1920 mm (6 ft. 4 in.)
- 7.73 m (25 ft. 4 in.)

Standard Linkage

- 1.1-m³ (1.4 cu. yd.)
- 2.75 m (9 ft. 0 in.)
- 1.98 m (6 ft. 6 in.)
- 285 mm (11 in.)
- 750 mm (30 in.)
- 2.15 m (7 ft. 1 in.)
- 5.68 m (18 ft. 7 in.)
- 3.22 m (10 ft. 7 in.)
- 2.45 m (8 ft. 0 in.)
- 1.15 m (3 ft. 9 in.)
- 1.76 m (5 ft. 9 in.)
- 55 mm (2 in.)
- 50 deg.
- 58 deg.
- 40 deg.
- 4.02 m (13 ft. 2 in.)
- 2.20 m (7 ft. 3 in.)
- 1510 mm (4 ft. 11 in.)
- 1920 mm (6 ft. 4 in.)
- 8.03 m (26 ft. 4 in.)

Capacity, Heaped (SAE)	0.8 m ³ (1.0 cu. yd.)	1.1 m ³ (1.4 cu. yd.)
Capacity, Struck (SAE)	0.66 m ³ (0.86 cu. yd.)	0.9 m ³ (1.18 cu. yd.)
Breakout Force (SAE J732C)	3645 kg (8,036 lb.)	3295 kg (7,264 lb.)
Tipping Load, Straight	3620 kg (7,981 lb.)	3500 kg (7,716 lb.)
Tipping Load, Full Turn (SAE)	3310 kg (7,297 lb.)	3200 kg (7,055 lb.)
Rated Operating Load, 50% of Full-Turn Tipping Load (conforms to ISO 14397-1)*	1655 kg (3,649 lb.)	1600 kg (3,527 lb.)

While general information, pictures, and descriptions are provided, some illustrations and text may include product options and accessories NOT AVAILABLE in all regions, and in some countries products and accessories may require modifications or additions to ensure compliance with the local regulations of those countries.

Dimensions and Specifications With Quik-Tatch Coupler and Fork

244 P-TIER

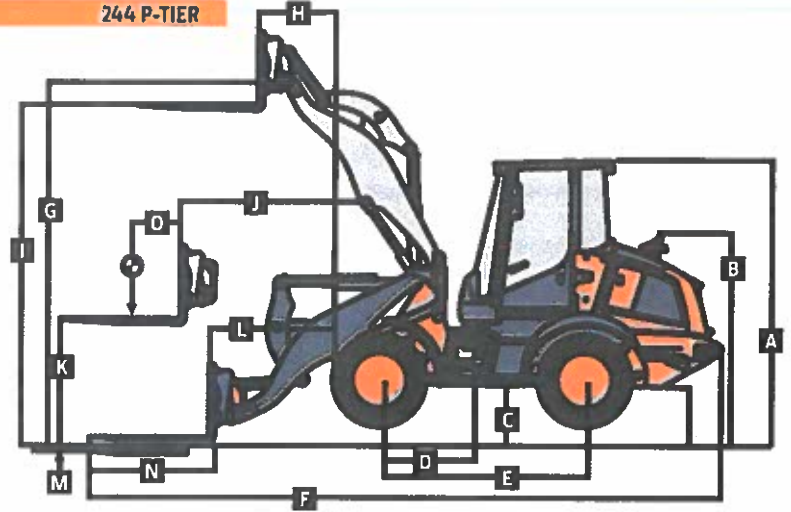

244 P-TIER Z-BAR LOADER WITH QUIK-TATCH COUPLER AND FORK

Dimensions With Quik-Tatch Coupler and Fork

- A Height to Top of Cab
- B Height to Top of Exhaust
- C Ground Clearance
- D Length From Centerline to Front Axle
- E Wheelbase
- F Overall Length, Forks on Ground
- G Height to Hinge Pin, Fully Raised
- H Reach, Fully Raised
- I Fork Height, Fully Raised
- J Maximum Reach, Fork Level
- K Fork Height, Maximum Reach
- L Reach, Ground Level
- M Depth Below Ground
- N Tine Length
- O Load Position, 50% Tine Length

Specifications With Quik-Tatch Coupler and Fork

- Tipping Load, Straight
- Tipping Load, Full Turn (SAE)
- Rated Operating Load, 50% Full-Turn Tipping Load (conforms to SAE J1197 / ISO 14397-1)*
- Rated Operating Load, Rough Terrain, 60% Full-Turn Tipping Load (conforms to EN474-3)*
- Rated Operating Load, Firm and Level Ground, 80% Full-Turn Tipping Load (conforms to EN474-3)*

Standard Linkage
1.20-m (48 in.) tine length

- 2.75 m (9 ft. 0 in.)
- 1.98 m (6 ft. 6 in.)
- 285 mm (11 in.)
- 750 mm (30 in.)
- 2.15 m (7 ft. 1 in.)
- 6.08 m (19 ft. 11 in.)
- 3.22 m (10 ft. 7 in.)
- 570 mm (22 in.)
- 3.03 m (9 ft. 11 in.)
- 1.28 m (4 ft. 2 in.)
- 1.42 m (4 ft. 8 in.)
- 785 mm (31 in.)
- 75 mm (3 in.)
- 1.20 m (48 in.)
- 600 mm (24 in.)

As measured with fork level, centered on tine

- 3060 kg (6,746 lb.)
- 2800 kg (6,173 lb.)
- 1400 kg (3,086 lb.)¹
- 1680 kg (3,704 lb.)¹
- 2160 kg (4,762 lb.)¹

*Rated operating capacity based on Deere attachments only. / ¹Payload on forks is limited by tilt cylinder.

Bucket Selection Guide

LOOSE MATERIALS	kg/m ³	#/cu. yd.	LOOSE MATERIALS	kg/m ³	#/cu. yd.
Chips, pulpwood	288	486	Limestone, coarse, dried	970	2,646
Cracked coal, ashes, cinders	673	1,104	Limestone, substandard or crushed	1682	2,835
Clay and gravel, dry	3602	2,300	Limestone, pulverized or crushed	1362	2,395
Clay, compact, solid	1746	2,943	Sand, damp	2083	3,570
Clay, dry in lump loose	1009	1,701	Sand, dry	1762	2,970
Clay, excavated in water	1282	2,360	Sand, voids, full of water	2083	3,570
Coal, anthracite, broken, loose	885	1,458	Sandstone, quarried	1314	2,274
Coal, bituminous, moderately wet	901	1,500	Shale, broken or crushed	1363	2,395
Earth, common loam, dry	1218	2,057	Slag, furnace granulated	1955	3,294
Earth, mud, packed	1843	3,105	Stone or gravel, 12.5 to 87.5 mm		
Granite, broken	1538	2,592	(1.5 to 3.5 in.) size	1667	2,430
Gypsum	2275	3,824	Stone or gravel, 18.75-mm (3/4 in.) size	1672	2,700

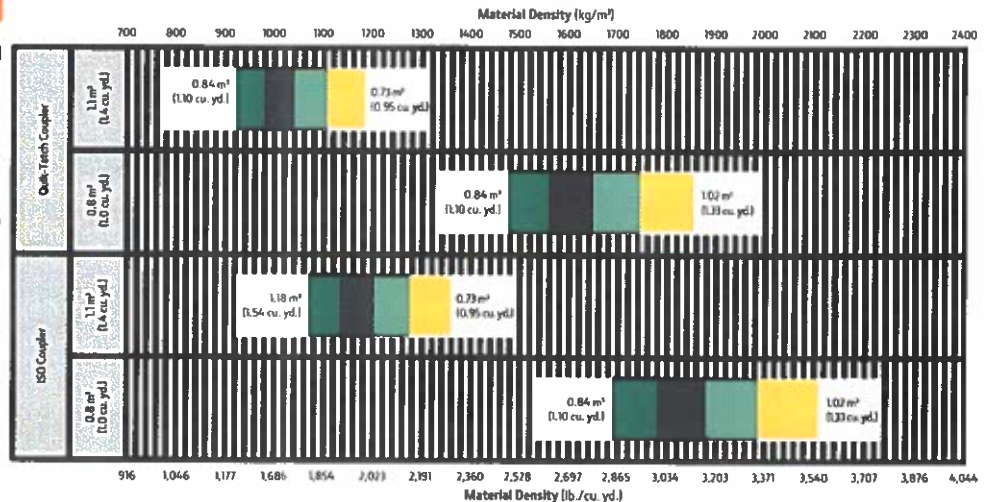

Additional equipment

Key: ● Standard ▲ Optional or special
See your John Deere dealer for further information.

244 P Engine

- Antifreeze, -37 deg. C (-34 deg. F)
- Coolant recovery tank
- Fan safety guard
- Fan, suction type, hydraulically driven, proportional speed
- Environmentally friendly engine oil drain
- Spin-on engine oil and fuel filter
- Engine oil cooler
- Quick-release fuel filter and water separator
- Under-hood dual-element air cleaner with restriction indicator with dust-evacuator valve
- Prescreened air intake
- Automatic glow plugs for cold start
- ▲ Engine coolant heater, 110 volts

Electrical

- Starter switch with electric fuel cutoff
- 12-volt system
- Electrical load center with blade-type fuses behind operator's seat
- Standard 925-CCA battery
- Master electrical disconnect switch
- Alternator, 12 volts, 80 amps
- Horn (conforms to SAE J994 / J1446)
- Lights (conform to SAE 99): Driving / Front working (2) / Turn signals / Flashers / Stop / Taillights
- Worklights, rear (2)
- Reverse warning alarm (conforms to SAE J994 / J1446)
- Multifunction monitor with audible and visual warnings: Low engine oil pressure, engine coolant temperature, hydraulic oil temperature warning light, and parking brake indicator / Gauge and indicator: Engine coolant temperature gauge, fuel level gauge, speedometer, clock, and hour meter
- Indicator lights: Engine air filter / Parking brake actuated / Forward/reverse travel / 1st- or 2nd-speed range / Turn signal and hazard lights / High-beam driving lights indicator / Battery voltage
- Pre-wired for roof beacon

Powertrain/Brakes

- Smooth AutoShift technology up to 38 km/h (23 mph)

244 P Powertrain/Brakes (continued)

- Hydrostatic (HST) transmission: Electric shift control / Single-lever joystick F-N-R / HST oil cooler / Inching pedal / 2 speeds forward and reverse / Infinitely variable speed control
- Rimpull control
- Service brakes, hydraulically actuated, self-adjusting internal wet-disc brake and driveline drum brake
- Parking brake, spring applied, hydraulically released, switch operated
- Conventional-type rear differentials, 100% locking front differential

Hydraulic System

- Hydraulic fan for demand-based cooling
- Hydraulic system oil cooler
- Automatic bucket return-to-dig control
- Boom float detent
- Reservoir sight gauge for hydraulic/HST oil
- Fine-micron hydraulic filters, vertical mounting
- Hydraulic function lockout
- 3-function hydraulic valve with pilot joystick control including auxiliary electrohydraulic (EH) proportional control for 3rd function
- ▲ 109-L/m (29 gpm) high-flow option
- Quick-coupler diagnostic ports: Priority pressure / Hydraulic pump pressure / Control valve pressure / HST pressure

Operator's Station

- Cab (conforms to SAE J1040, SAE J231, ISO 3471, and ISO 3449): ROPS/FOPS / Heater/defroster / Rubber-plane isolation mounted for noise/vibration reduction / Intermittent front and rear windshield wipers and washers / Tinted safety glass / Adjustable sun visor / Mid-back cloth seat with mechanical suspension / 51-mm (2 in.) retractable seat belt / Full swing-out left and right doors with sliding window in left door
- ▲ Premium air-ride high-back heated seat with headrest and dual lumbar control
- Radio-ready cab, fused 12-volt radio electrical lead and speakers, and power port
- ▲ AM/FM/Weather-Band (WB) radio

244 P Operator's Station (continued)

- Air conditioning
- Storage compartment for operator's manual and other items located under operator seat and 2 options left of operator seat
- Rubber floor mat
- Dual tilt and telescoping steering column
- Rearview mirrors, outside (2) and inside (1) (conform to SAE J985)
- Handholds and steps, ergonomically located and slip resistant (conform to SAE J185)
- ▲ 76-mm (3 in.) retractable seat belt

Loader Linkage

- Z-Bar loader linkage provides high bucket breakout
- Loader boom service locking bar (conforms to SAE J38)

Buckets and Attachments

- ▲ Full line of buckets with bolt-on cutting edges
- ▲ ISO-style quick-coupler
- ▲ Quik-Tatch™ coupler
- ▲ Full line of construction utility forks, pallet forks, and other John Deere attachments*

Tires

- 365/70R18 Mitas EM-01
- ▲ 405/70R18 Firestone Duraforce
- ▲ 400/70R20 Michelin XMCL
- ▲ 400/70R20 Michelin Bibload
- ▲ 400/70R20 Nokian Hakkapeliitta

Other

- ▲ LED worklights (spot or flood)
- ▲ Hydraulic reversing fan
- ▲ Front window guard
- Fenders, front and rear
- Articulation locking bar (conforms to SAE J276)
- Vandal protection, includes lockable engine enclosure and fuel fill
- Cast rear counterweight
- Drawbar, with locking pin
- Life eyes
- Tie-downs
- Ride control
- ▲ Creep control/throttle lock
- ▲ Fire extinguisher

*See your John Deere dealer for further information.

While general information, pictures, and descriptions are provided, some illustrations and text may include product options and accessories NOT AVAILABLE in all regions, and in some countries products and accessories may require modifications or additions to ensure compliance with the local regulations of those countries.

Net engine power is with standard equipment including air cleaner, exhaust system, alternator, and cooling fan, at standard conditions per SAE J1349 and DIN 70 020, using No. 2-D fuel at 35 API gravity. No derating is required up to 1500-m (5,000 ft.) altitude. Gross power is without cooling fan. Specifications and design subject to change without notice. Wherever applicable, specifications are in accordance with SAE standards. Except where otherwise noted, these specifications are based on a unit with all standard equipment, ROPS cab, 365/70R18 Mitas EM-01 tires, full fuel tank, air conditioning off, and 79-kg (175 lb.) operator.



MW244PAU (23-05)



JOHN DEERE



STANDARD WARRANTY FOR NEW JOHN DEERE CONSTRUCTION, COMPACT CONSTRUCTION (CCE) FORESTRY, AND UTILITY PRODUCTS – US & CANADA

- **Construction & Forestry Products:** 12 months/unlimited hours (whichever occurs first) Full Machine Standard Warranty
- **Compact Construction Equipment (CCE) Products:** 24 months or 2000 hours (whichever occurs first) Full Machine Standard Warranty
- **C&E Series Pull-Type Scrapers:** 6 months Full Machine Standard Warranty
- **DC & DE Pull-Type Scrapers:** 12 months Full Machine Standard Warranty
- **Scraper Tractors:** 24 Months or 2000 Hours (whichever occurs first) Full Machine Standard Warranty
- **Forestry Attachments:** 12 Months or 2000 Hours (whichever occurs first) Full Machine Standard Warranty

The "Standard Warranty" is part of the warranty protection package available from John Deere Construction & Forestry Company (John Deere Limited in Canada) ("John Deere") to purchasers of new John Deere products ("product"):

STANDARD Warranty is John Deere's standard new product warranty, described in this document, provided at no additional charge to the purchaser.

EXTENDED Warranty is a separate repair contract made available by John Deere for purchasers who wish to complement their Standard Warranty coverage. Complete Extended Warranty details, including coverage options and limitations, are set forth in the Application for Extended Warranty, which is available from authorized John Deere dealers.

STRUCTURALL Warranty applies to certain structural components as listed below and as described in this document.

FACTORY-INSTALLED UNDERCARRIAGE Warranty applies to certain undercarriage components as listed below and as described in this document.

A. STANDARD WARRANTY - GENERAL PROVISIONS

John Deere will repair or replace, at its option, any parts (except those specified below) of a new John Deere product that, as delivered to the original retail purchaser(s), are defective in material or workmanship. Performance of this warranty will be free of charge for parts and labor, except as otherwise stated below. Standard Warranty applies only to purchases from John Deere and authorized John Deere dealers and, except as otherwise provided in the next sentence and section L below, is extended only to the original retail purchaser of the product. Remaining Standard Warranty applicable to a used John Deere product is transferred to a subsequent purchaser of the product only if the subsequent purchaser requests a transfer from an authorized John Deere dealer before the product's Standard Warranty expires. Coverage begins on the date of delivery of the product to the original retail purchaser. For purposes of this warranty, a product that has been rented, used for demonstration purposes for 150 or more hours, or otherwise used prior to its original retail purchase has been "used" for the total duration of such use. Warranty statements required by law covering engine emissions-related parts and components are found on a separate written warranty certificate provided to the purchaser at the time of the original retail purchase.

B. WHAT IS COVERED BY STANDARD WARRANTY

All parts of a new John Deere product (except those noted in Sections D and E below) are covered during the Standard Warranty period set out above.

C. EXCLUSIVE REMEDY

The repair or replacement of covered parts or components that are defective, as provided in Sections A, B, D.2 and D.3 herein, shall be the purchaser's exclusive remedy for any defect in the product. However, if after repeated attempts such repair or replacement fails to correct the performance problem caused by the defect, the purchaser's sole remedy shall be a refund of the amount paid for the product (in exchange for a return of the product), excluding any transportation charges, license fees, taxes and insurance premiums, and less a reasonable allowance for use of the product prior to its return. In no event will the dealer, John Deere or any company affiliated with John Deere be liable for any incidental or consequential damages, including but not limited to loss of profits, rental of substitute equipment or other commercial loss. Correction of defects in the manner provided above shall constitute fulfillment of

all liabilities of the Dealer, John Deere, or any company affiliated with John Deere to the purchaser or any other person, whether based upon contract, tort, strict liability, or otherwise. This limitation does not apply to claims for personal injury.

D. ITEMS COVERED SEPARATELY -

1. **Standard Warranty** does not apply to batteries, radios, tires, cameras, or to Cummins, MTU or Detroit Diesel Engines installed in John Deere products, which are covered by separate written warranties.
2. **Factory-Installed Undercarriage Warranty** covers all non-rubberized factory-installed undercarriage wear components for 3 years or 4,000 hours from the date of delivery to the original retail purchaser, whichever occurs first (unless terminated earlier under Section F, below). For purposes of this warranty, a product that has been rented, used for demonstration purposes for 150 or more hours, or otherwise used prior to its original retail purchase has been "used" for the total duration of such use. In addition to the items listed in section E below, **Factory-Installed Undercarriage Warranty** does not cover: failures due to wear, machine application, maintenance practices, or improper machine configuration; removal and installation labor; transportation or hauling costs; unapproved parts; non-wear items; and rubberized undercarriage components such as rubber tracks. Warranty claims will be pro-rated based upon wear of the failed component and whether track shoe width is approved by John Deere. **Factory-Installed Undercarriage Warranty** does not apply to Scraper Tractors.
3. **StructurALL Warranty** for new John Deere Products (except Compact Excavators & Loaders, Skid-Steer Loaders, Compact Track Loaders, Scraper Tractors, Pull-Type Scrapers, and Forestry Attachments, which are not eligible for **StructurALL Warranty**) begins at the date of delivery to the original retail purchaser and ends (unless terminated earlier under Section F, below) after three (3) years, or 10,000 hours (whichever occurs first). For purposes of this warranty, a product that has been rented, used for demonstration purposes for 150 or more hours, or otherwise used prior to its original retail purchase has been "used" for the total duration of such use. **StructurALL Warranty applies only to the following structural components listed below as installed on the product at the time of original manufacture.** If a particular component is not listed below it is not covered by **StructurALL Warranty**.

Arm; Articulation Joint (incl. pins & bushings); Bin Frame; Boom; Carbody; C-Frame*; Circle Frame; Coupler (John Deere built ONLY); Dipperstick; Draft Frame; Engine Frame; Equipment Frame; Grapple Arch and Grapple Boom; Loader Arm; Loader Frame; Mainframe; Moldboard Lift Arm; Pushbeam, NeverGrease™ Pin Joints [Includes steering pin and bushing joints (standard equipment), roller elements (roller bearings) in bucket to boom joints and sliding elements (bushing) for boom and linkage joints (optional equipment)]; Rollover Protection Structure (ROPS); Side Frame; Swing Frame; Track Frame; Undercarriage Frame; X-Frame; Z-bar loader linkage (including bell crank and bucket driver link); Specialty booms and arms marketed as "heavy duty" by John Deere.

Items Covered by StructurALL for Cut-to-Length Forestry Machines: Front frame (welded assembly); Rear frame (welded assembly); Crane king post with basement; Middle joint frame; Cabin swing frame; Main Boom

StructurALL Warranty does not apply to:

1. Any product used primarily in extreme duty or severe duty applications such as but not limited to: demolition and wrecking, chemical plant (including fertilizer plants), salt mines, steel mill, land fill and transfer stations, scrap handling, scarifying and other applications that are similarly destructive or similarly heavy duty except specialty booms and arms as stated in Section D.3 above.
2. C-Frames on Crawlers equipped with root rakes or used in forestry applications unless equipped with an "extreme duty" reinforcement package.
3. Cut-to-Length Forestry Heads and Slash Bundler Units.
4. Crawlers equipped with optional side booms.
5. Cut-to-Length Forestry, Excavator, and Log Loader swing bearings.
6. Motor Graders equipped with front- or rear-mounted snow wings.

E. ITEMS NOT COVERED -

John Deere is NOT responsible for the following:

1. Freight.
2. Adjustments to compensate for wear, for periodic maintenance or adjustments that result from normal wear and tear.
3. Damage caused by unapproved adjustments (electronic or mechanical) to machine or machine components outside of published specifications including but not limited to engine, hydraulic components and relief valves.
4. Program updates, calibrations, and pressure adjustments.
5. Additional Labor Time - Above Dealer Labor Rate.
6. Additional Cleaning - Above Dealer Labor Rate.
7. Rental Fees.
8. Depreciation or damage caused by normal wear or application, lack of reasonable and proper maintenance, failure to follow operating instructions, misuse, lack of proper protection during storage, vandalism, negligence, collision, expenses to seek reinstatement of warranty following theft or loss of Product, or other accidents.
9. Premiums charged for Overtime Labor.
10. Transportation to and from the dealership.
11. Travel time, mileage, or service calls by the dealer.
12. Non-John Deere components or modifications, Rotobec grapples, and attachments installed aftermarket.
13. Shop supplies and maintenance items such as, but not limited to: filters, fuels, oil, hydraulic fluid, lubricants, coolants, conditioners, shop towels, cleaners and degreasers.
14. Torn, cut, or worn hoses.
15. Wear items, such as, but not limited to: body liner, belts, blades, bulbs, lubricated joints (including pins and bushings), dry brakes, brake linings, dry clutch linings, saw blades, chains, skidder grapple shocks, color marking nozzles, and articulation bumpers.
16. Items such as cutting-edge parts, delimiting knives, bucket teeth and rubber track are not warranted for depreciation or damage caused by normal wear, lack of proper maintenance, misuse, failure to follow operating instructions, the elements or accident.
17. Any defect in a non-covered component, or damage to or failure of a covered component caused by a defect in a non-covered component.
18. Secondary damage which occurs from continued operation of a product after recognition of the occurrence of a failure.
19. Parts supplied by or repairs, maintenance or modifications performed by someone other than an authorized John Deere dealer, including any damage caused by such use of parts, repairs, maintenance, or modifications not performed by an authorized John Deere dealer.
20. The use of "track type" tire chains on Feller Bunchers and Skidders is an unapproved modification. Warranty will be void on these machines using "track type" tire chains.
21. Topping off fluids when fluid levels fall in the range between low and full
22. Parts/Kits not ordered on machine and installed aftermarket. These parts will be covered by any applicable parts warranty.
23. Attachments installed aftermarket – i.e., Winch not installed at factory.
24. Custom options installed outside the factory – i.e., G.R. Manufacturing option packages.
25. Used Products (except as otherwise provided in section L below).
26. Lost or stolen Products.

F. TERMINATION OF WARRANTY-

John Deere is relieved of its obligations under Standard Warranty, StructurALL Warranty, Factory-Installed Undercarriage Warranty and/or Extended Warranty if:

1. The product is modified or altered in ways not approved by John Deere; or
2. Any unapproved or improperly sized attachment is installed on the product. Approval and attachment size shall be at John Deere's sole discretion. (Consult dealer prior to installing attachments or product modification).
3. The product is moved outside the US and/or Canada.

G. PARTS REPLACED UNDER WARRANTY -

Only new or remanufactured parts or components furnished or approved by John Deere, will be used if John Deere elects to repair the product. If any such part or component is defective in material or workmanship when installed in the product, John Deere will repair or replace, as it elects, such defective part or component, provided the defect is reported to an authorized John Deere dealer within 90 days of installation or before expiration of the applicable Standard Warranty, Factory-Installed Undercarriage Warranty and/or StructurALL Warranty whichever is later.

H. TELEMATICS

NOTICE: Products may be equipped with telematics hardware and software ("Telematics") that transmit data to John Deere/ Dealer. Purchaser may deactivate Telematics at www.jdlink.com.

Notwithstanding Purchaser's right, title or interest in the Products, Purchaser agrees that John Deere and Dealer (their affiliates, successors and assigns), without further notice to Purchaser have the right to:

1. Access, use, collect and disclose any data generated by, collected by, or stored in, Products or any hardware or devices interfacing with Products ("Machine Data");
2. Access Machine Data directly through data reporting devices integrated within, or attached to, Products, including Telematics ("Data Reporting Systems"); and
3. Update the Data Reporting Systems software from time to time. Machine Data will only be used in accordance with John Deere's Machine Data Policy, located at www.JohnDeere.com/MachineDataPolicy.

I. OBTAINING WARRANTY SERVICE -

To obtain warranty service, the purchaser must request warranty service from a John Deere dealer authorized to sell the product to be serviced. When making such a request, the purchaser must present evidence of the product's delivery date, make the product available at the dealer's place of business, and inform the dealer in what way the purchaser believes the product to be defective. Standard Warranty, Factory-Installed Undercarriage Warranty and/or StructurALL Warranty repairs may be made in the field if the purchaser and servicing dealer so desire. However, John Deere will not be responsible for any charges (such as dealer travel time, mileage or extra labor) that would not have been incurred had the product been repaired at the dealer's place of business.

J. NO IMPLIED WARRANTY, CONDITIONS OR OTHER REPRESENTATION -

Where permitted by law, neither John Deere nor any company affiliated with it makes any warranties, representations, conditions or promises, express or implied, as to the quality, performance, or freedom from defect of its products, other than those set forth in this document and **NO IMPLIED WARRANTY OF MERCHANTABILITY, CONDITIONS OR FITNESS IS MADE.**

K. NO DEALER WARRANTY -

The selling dealer makes no warranty of its own on any item covered by this warranty and makes no warranty on other items unless the dealer delivers to the purchaser a separate written warranty certificate specifically warranting the item. **The dealer has no authority to make any representation or promise on behalf of John Deere, or to modify the terms or limitations of this warranty in any way.**

L. USED JOHN DEERE PRODUCTS ONLY -

John Deere will transfer remaining Standard Warranty, Factory-Installed Undercarriage Warranty and/or StructurALL Warranty to the purchaser of a used John Deere construction and/or forestry product that has been used for less than the full warranty period provided at the product's original retail purchase. This transfer is not effective until change of ownership is registered by a John Deere dealer. **ALL THE TERMS, INCLUDING LIMITATIONS AND EXCLUSIONS, OF THE JOHN DEERE STANDARD WARRANTY, FACTORY-INSTALLED UNDERCARRIAGE WARRANTY, AND/OR STRUCTURALL WARRANTY ORIGINALLY PROVIDED FOR THE PRODUCT REMAIN IN EFFECT AND APPLICABLE.**

TINK BUCKETS



Load A
Compactor Truck



Load An
Open Top Truck



Efficient Collection
Of Leaves & Brush

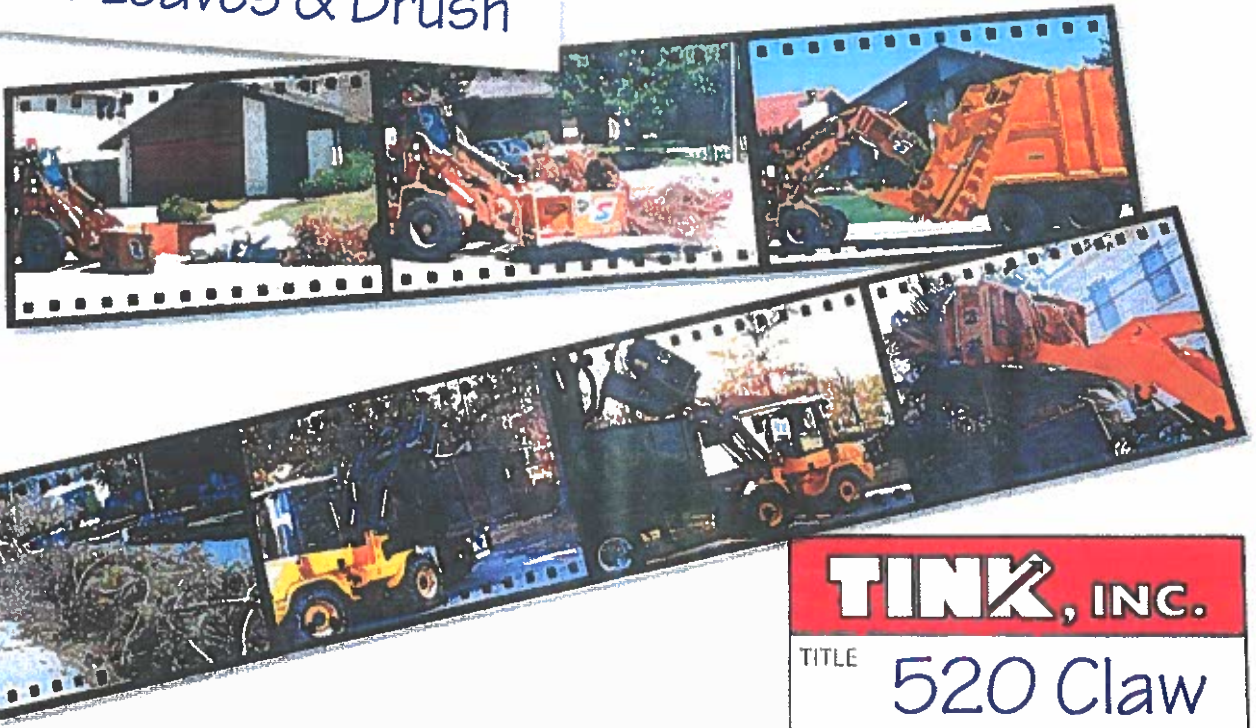

TINK, INC.
TITLE 520 Claw

DESIGN FEATURES

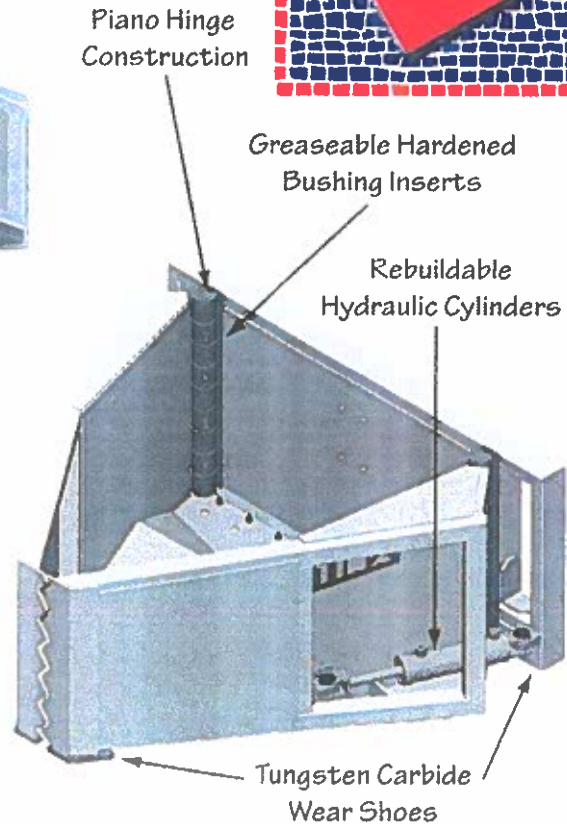
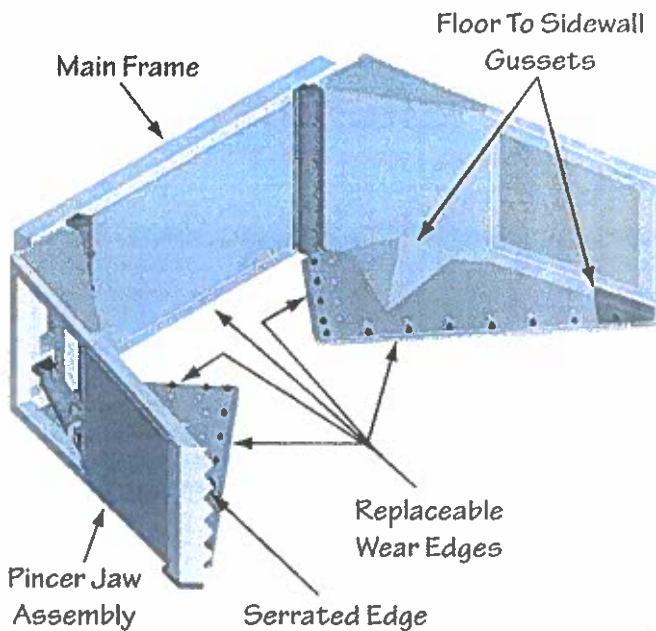

Tink 520 Claw

A special loader bucket that scoops leaves and loose garden waste out of the gutter and into disposal trucks at lower costs. The Claw can be mounted on most $\frac{3}{4}$ to $1\frac{1}{2}$ yard wheel loaders.

The **Pincer Jaw Assembly** is constructed of structural steel tubing welded together to form rigid rectangular frames. The framework is covered and strengthened with steel side panels. The serrated front edges assist in grasping and pinching materials.

Wear Provisions The underside of the Claw, which makes frequent contact with asphalt and other hard surfaces, is equipped with replaceable tungsten carbide wear shoes and hard steel blades that absorb a majority of the abrasion and wear. Tungsten carbide is an extremely hard material that is incorporated into the wear shoes to combine the highest wear and abrasion resistance possible with strength and impact resistance.

Piano-Hinge Construction The pincer jaw assembly is attached to the main frame with a 3 inch diameter piano-hinge that features a $1\frac{1}{2}$ inch pin that won't shear on impact. More importantly the large diameter provides a vast amount of wear surface to promote long lasting life. The hinges include greaseable hardened bushing inserts.

Hydraulic System The rebuildable twin cylinders that open and close the Claw are capable of developing pinch force necessary to grasp and hold materials too long or bulky to fit within the pincer bucket. The cylinders have a 3 inch bore, an 8 inch stroke and a $1\frac{1}{4}$ inch chrome hardened rod. Mechanical stops prevent cylinder damage by not allowing the cylinders to over extend during the Claw's duty cycle.

When the pincer jaws make contact with an immovable object the hydraulic cross over relief valve senses the obstruction a diverts the fluid away from the cylinders. This automatic action minimizes cylinder damage and premature hydraulic system failure.

The flow divider distributes an equal amount of hydraulic fluid to each cylinder ensuring that the pincer jaws operate evenly and simultaneously.

The 520 Claw hydraulic system is designed for machines having 8 to 50 gpm and 1500 to 3800 psi.

Prices and specifications are subject to change without notice.

TINK, Inc. • 2361 Durham Dayton Hwy • Durham CA 95938 • 800-824-4163 • © 2002

TINK CLAW PRICES AND SPECIFICATIONS

The Most Efficient Collection of Leaves and Brush



Doing business since 1976.

Tink is a name to trust.

MODEL NUMBER	CUBIC YARD	WIDTH CLOSED	WIDTH OPEN	BACK WALL HEIGHT	MAX LENGTH	SHIP WEIGHT WITH BRACKETS	LIST PRICE WITH BRACKETS
C520	1.2	66"	96"	29"	57"	1725 LBS	\$14,925
C720	2.7	69"	114"	29"	81"	2900 LBS	\$19,100

TINK CLAW SELECTION GUIDE

	TIP LOAD FULL TURN	TIP LOAD STRAIGHT	CLAW MODEL	
100 Category - 1.0 Yard Loader	6,300 lbs.	7,200 lbs.	520	
125 Category - 1.25 Yard Loader	7,800 lbs.	9,000 lbs.	520	
150 Category - 1.50 Yard Loader	9,400 lbs.	10,900 lbs.	520	
175 Category - 1.75 Yard Loader	11,000 lbs.	12,700 lbs.	520	720
200 Category - 2.0 Yard Loader	12,600 lbs.	14,200 lbs.		720
225 Category - 2.25 Yard Loader	14,200 lbs.	16,500 lbs.		720
250 Category - 2.50 Yard Loader	15,700 lbs.	18,200 lbs.		720
275 Category - 2.75 Yard Loader	17,300 lbs.	20,100 lbs.		720

C720 ILLUSTRATIONS

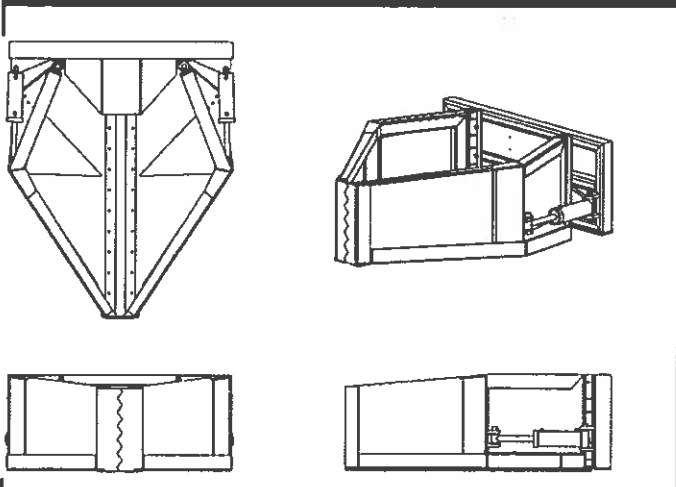

C520 ILLUSTRATIONS

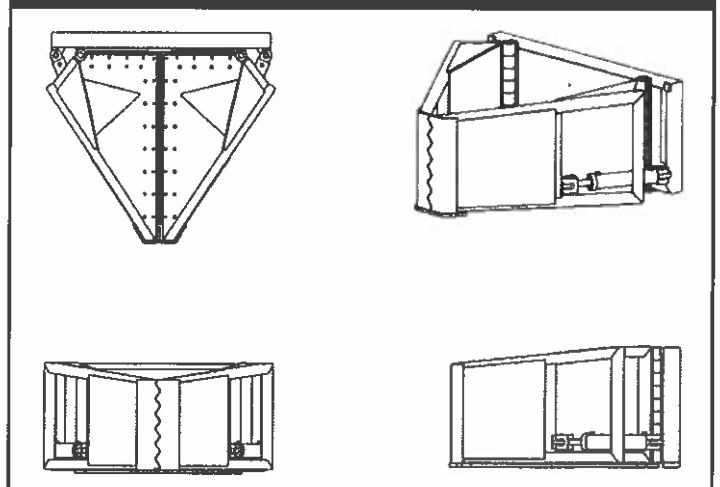

Prices and specifications subject to change without notice. Prices FOB Durham, CA. Effective 1/1/23

Tink, Inc. • Durham, CA • 800-824-4163 • www.tinkinc.com



MULTI-PURPOSE BUCKETS

TWO MODELS FOR EVERY APPLICATION

VERSATILE

Need to be able to grip, grab, pull and lift? Need to grade, doze, or dig and load? If so, your machine deserves a Rockland Multi-Purpose Bucket. These buckets are designed to perform and built to last. They deliver true versatility without changing attachments.

The MP is ideal for utility work and general contractors.

TWO MODELS FOR EVERY APPLICATION

It excavates, loads, and clears land—virtually whatever the job may require.

The MP-L was designed specifically for trash transfer stations. Its ability to crush, pick, sort, and doze really increases trash handling efficiency.

BUILT TO LAST

Both models are built to last in the Rockland tradition. Heavy-duty clams, oversize pivots, and hard alloy wear strips guarantee years of dependable service. Hydraulics are the heart of any multi-purpose bucket and Rockland hydraulics are first-class. High pressure cylinders with special heat-treated, hard chrome-plated rods deliver dependability—year after year. All moldboards are reinforced with box sections and equipped with bolt-on cutting edges and replaceable end bits. Clams can be equipped with bolt-on cutting edges or the teeth of your choice.

This all adds up to versatility, productivity, and dependability. If you are thinking Multi-Purpose buckets, specify Rockland. You will be glad you did!

MP MULTI-PURPOSE

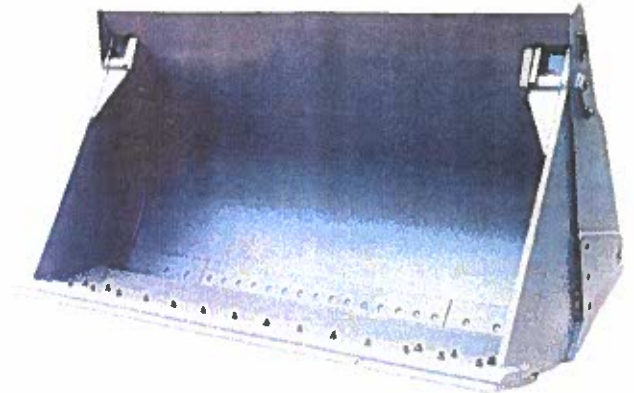

Rockland MP Buckets are ideal for utility work and general contractors.

MP-L TRASH HANDLING

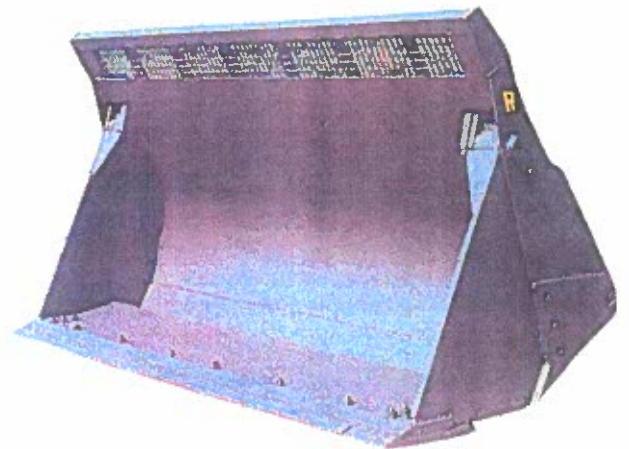

Transfer station operators appreciate the versatility of the Rockland MP-L because of the way it really speeds trash handling.

MP MULTI-PURPOSE

WHEEL LOADER

MACHINE CLASS	5,10		10		10		10,20		20,30		20,30		30,40		40		40,50	
CAPACITY (Yd³)	1	.76	1.25	.96	1.375	1.05	1.5	1.15	1.75	1.34	2	1.53	2.25	1.72	2.5	1.91	2.75	2.1
OAW (")	88	2235	89	2261	95	2413	95	2413	96	2438	96	2438	100	2540	106	2692	106	2692
CEW (")	86.5	2197	87.5	2223	93.5	2375	93	2362	94	2388	94	2388	98	2489	104	2642	104	2642
WEIGHT (lbs.)	1735	787	2045	928	2145	973	2360	1071	3060	1388	3260	1479	3600	1633	3790	1719	4190	1901

MACHINE CLASS	50		50		50,60		60		60		60,70		70		70		80	
CAPACITY (Yd³)	3	2.29	3.25	2.48	3.5	2.68	3.75	2.87	4	3.06	4.25	3.25	4.5	3.44	4.75	3.63	5	3.82
OAW (")	116	2946	116	2946	122	3099	126	3200	132	3353	135	3429	144	3658	144	3658	144	3658
CEW (")	114	2896	114	2896	120	3048	124	3150	130	3302	133	3378	142	3607	142	3607	142	3607
WEIGHT (lbs.)	4500	2041	4900	2223	5380	2440	5480	2486	5680	2576	6110	2772	7275	3300	7775	3527	8575	3890

(mm/kg)

Specifications subject to change without notice.

CRAWLER LOADER

MACHINE CLASS	10		10,20		20		20,30		30		30,40		40		40,50		50	
CAPACITY (Yd³)	1	0.76	1.25	0.96	1.375	1.05	1.5	1.15	1.75	1.34	2	1.53	2.25	1.72	2.5	1.91	2.75	2.1
OAW (")	76	1930	80	2032	84	2134	84	2134	90	2286	92	2337	96	2438	100	2540	100	2540
CEW (")	74	1880	78	1981	82	2083	82	2083	88	2235	90	2286	94	2388	98	2489	98	2489
WEIGHT (lbs.)	1765	801	2395	1086	2595	1177	2795	1268	3360	1524	3615	1640	3855	1749	4300	1950	4655	2112

MACHINE CLASS	50,60		60		60	
CAPACITY (Yd³)	3	2.29	3.25	2.48	3.5	2.68
OAW (")	106	2692	106	2692	110	2794
CEW (")	104	2642	104	2642	108	2743
WEIGHT (lbs.)	5320	2413	5620	2549	6720	3048

(mm/kg)

Specifications subject to change without notice.

MP-L TRASH HANDLING

MP-L Trash Handling Bucket capacity should be determined by the weight of the material usually handled and the operating capacity of the loader. Often a bucket larger than the standard multi-purpose bucket can be used to maximize productivity.

MACHINE CLASS	10		20		20		30		30		40		40		50		50		60	
CAPACITY (Yd³)	2.75	2.1	2.75	2.1	4	3.06	4	3.06	5	3.82	5	3.82	6.75	5.16	6.75	5.16	7.75	5.93	7.75	5.93
OAW (")	96	2438	96	2438	106	2692	106	2692	106	2692	106	2692	120	3048	120	3048	130	3302	130	3302
CEW (")	94	2388	94	2388	104	2642	104	2642	104	2642	104	2642	118	2997	118	2997	128	3251	128	3251
WEIGHT (lbs.)	3295	1495	3760	1706	4090	1855	4490	2037	4900	2223	5465	2479	6000	2722	6380	2894	6755	3064	7530	3416

(mm/kg)

Specifications subject to change without notice.

INSTALLATION INFORMATION

Rockland MP buckets mount in place of the standard bucket using factory pins or specified coupler brackets. The loader must be equipped with a three-spool valve and boom arm piping. MP buckets come complete with jumper hoses to connect to standard boom arm piping.

WARRANTY

Rockland Multi-Purpose Buckets are guaranteed against failure due to defective design, workmanship or materials for a period of two years or 4000 hours.



Distributed by:

ROCKLAND MANUFACTURING CO.
P O BOX 5
800-458-3773
BEDFORD, PA 15522
www.rocklandmfg.com

Haugen

Skid-Steer Pick-up Brooms

877-580-6218

*Pick-up for
Skidsteer Loaders*

26 inch Diameter Brush

*Sweep
forward or reverse*

Optional Gutter Broom

Optional Sprinkler Kit

*Available in 60", 72" and
84" widths*



SPECIFICATIONS

Model	HPB 60	HPB 72	HPB 84
Sweeping Width	63"	75"	87"
Overall Width	70"	82"	94"
Overall Height	28"	28"	28"
Overall Front to Back	65"	65"	65"
Bristle Diameter	26"	26"	26"
Number of Bristles			
Zig-zag	35	40	45
Bristle Material			
(Standard)	Polypropylene	Polypropylene	Polypropylene
(Optional)	Poly/Steel Mix	Poly/Steel Mix	Poly/Steel Mix
Hydraulic Flow Min/Max	15/35	18 / 35	18 / 35
Hydraulic Pressure Max.	3500 Psi	3500 Psi	3500 Psi
Travel Direction	Forward / Reverse	Forward / Reverse	Forward / Reverse
Approximate Weight	995 lbs	1195 lbs	1395 lbs

Marv Haugen Enterprises Inc.

P.O. Box 868 • Casselton, ND 58012 • Phone: 701-347-4827 • Fax: 701-347-4830

Website: www.equipitnow.com • E-mail: haugen@equipitnow.com

Pick-Up Broom Specifications

Model	HPB 60	HPB 72	HPB 84
Overall Width	70"	82"	94"
Sweeping Width	63"	75"	87"
Overall Height	26"	26"	28"
Overall Front to Back	65"	65"	65"
Bristle Diameter	26"	26"	26"
No. of Bristles - Convolute	35	40	45
Bristle Material - Standard	Polypropylene	Polypropylene	Polypropylene
- Optional	Poly/Steel Mix	Poly/Steel Mix	Poly/Steel Mix
Drive System	Hyd. Motor Direct Drive	Hyd. Motor Direct Drive	Hyd. Motor Direct Drive
Hydraulic Flow Min/Max	15/35	18/35	18/35
Hydraulic Pressure Max	3500 PSI	3500 PSI	3500 PSI
Travel Direction	Forward/Reverse	Forward/Reverse	Forward/Reverse
Approximate Weight	995 lbs	1195 lbs	1395 lbs
Optional Water Kit	Available	Available	Available

Pick-Up Broom Dimensions

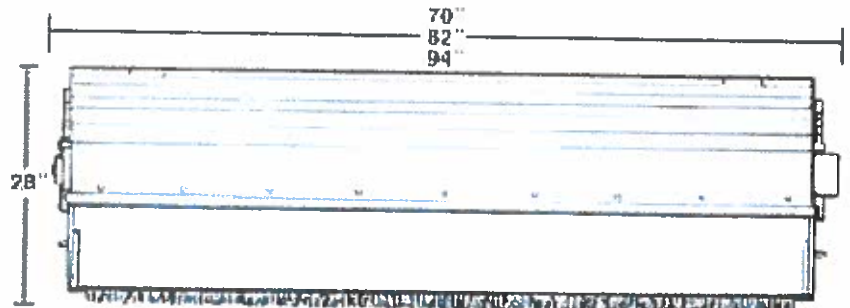
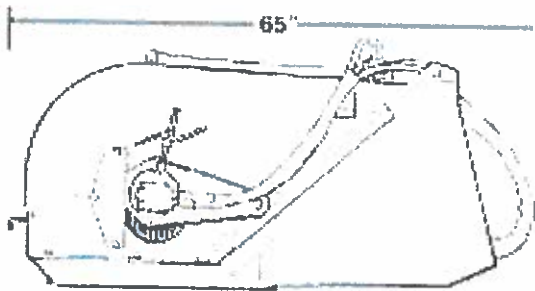

- Designed to be used on 5x4 steer loaders with 1300 lb or more lifting capacity
- Specifications and designs are subject to change without notice

Haugen

Marv Haugen Enterprises Inc.
 1851 Heartland Ave. - Casselton, ND 58012
Toll Free 877-580-6218
 Phone: 701-347-4827 Fax: 701-347-4830
 Website: www.haugenattachments.com
 Email: haugen@equipitnow.com



GSWA PROCUREMENT RECORD Page 450
GUAM SOLID WASTE AUTHORITY



LOURDES A. LEON GUERRERO
Supervisor of Offices

JOSHUA F. TENORIO
Supervisor of Operations

IRVIN L. SLIKE
General Manager

November 27, 2023

INVITATION FOR BID
GSWA-004-24
COMPACT WHEEL LOADER W/ ATTACHMENTS

AMENDMENT NO. 3

- 1. Amend page 31 of 34

From:

Bid Due Date & Bid Opening at the Guam Solid Waste Authority: Administration Office, GSWA Bldg., 2nd Fl. 546 N. Marine Corps Dr., Tamuning, Guam

Tuesday, November 28, 2023
at 1:00PM
Chamorro Standard Time

To Now Read:

Bid Due Date & Bid Opening at the Guam Solid Waste Authority: Administration Office, GSWA Bldg., 2nd Fl. 546 N. Marine Corps Dr., Tamuning, Guam

Tuesday, December 5, 2023
at 1:00PM
Chamorro Standard Time

*All others remain the same.

Irvin L. Slike,
General Manager

ACKNOWLEDGEMENT RECEIPT	
Return to GSWA by email or fax.	
Received By:	<i>Ryne-Paul Santos</i>
Date:	<i>11/20/23</i>
Company Name:	<i>Far East Equipment Co. LLC</i>
Fax to: 671 649 3777	
Email: procurement@gswa.guam.gov	



GSWA PROCUREMENT RECORD Page 451
GUAM SOLID WASTE AUTHORITY

LOURDES A. LEON GUERRERO
Secretary of Council

JOSHUA F. TENORIO
Chief of Administration

IRVIN L. SLIKE
General Manager



November 20, 2023

INVITATION FOR BID
GSWA-004-24
COMPACT WHEEL LOADER W/ ATTACHMENTS
AMENDMENT NO. 2

1. Amend page 31 of 34

From:

Deadline for Receipt of Written Questions must be e-mailed to the Guam Solid Waste Authority at procurement@gswa.guam.gov , ATTN: General Manager	Wednesday, November 15, 2023 on or before 5:00PM Chamorro Standard Time
--	---

To Now Read:

Deadline for Receipt of Written Questions must be e-mailed to the Guam Solid Waste Authority at procurement@gswa.guam.gov , ATTN: General Manager	Tuesday, November 21, 2023 on or before 5:00PM Chamorro Standard Time
--	---

2. Amend page 31 of 34

From:

Bid Due Date & Bid Opening at the Guam Solid Waste Authority: Administration Office, GSWA Bldg., 2 nd Fl. 546 N. Marine Corps Dr., Tamuning, Guam	Wednesday, November 22, 2023 at 1:00PM Chamorro Standard Time
--	---

To Now Read:

Bid Due Date & Bid Opening at the Guam Solid Waste Authority: Administration Office, GSWA Bldg., 2 nd Fl. 546 N. Marine Corps Dr., Tamuning, Guam	Tuesday, November 28, 2023 at 1:00PM Chamorro Standard Time
--	---

3. Amend to replace pages 32 of 34 through 34 of 34 with the "Revised 11/20/2023 Page 32" through "Revised 11/20/2023 Page 34" attached.

*All others remain the same.

Irvin L. Slike,
 General Manager

ACKNOWLEDGEMENT RECEIPT	
Return to GSWA by email or fax.	
Received by	<i>Ryne Paul Santos</i>
Date:	<i>11/20/23</i>
Company Name	<i>Far East Equipment Co. LLC</i>
Fax to: 671 649 3777	
Email: procurement@gswa.guam.gov	



GUAM SOLID WASTE AUTHORITY

LOURDES A. LEON GUERRERO
Governor of Guam

JOSHUA TENOREO
Lt. Governor of Guam

IRVIN L. SLIKE
General Manager



ITEM NO.	DESCRIPTION	QTY	UOM	UNIT PRICE	PRICE EXTENSION
1.0	Compact Wheel Loader w/ Attachments	1	EA	\$ _____	\$ _____

SPECIFICATIONS:

Indicate on each line of the technical specifications whether or not each item complies with the specification or an exception is being taken. If additional space is required to fully explain bid exceptions, attach additional typed page(s) to the bid submittal indicating the section number and subsection that has the exception, and provide explanation.

COMPLY / NON-COMPLY

Engine:

Gross HP at 2400 RPM: 73 HP minimum

Peak Torque at 1560 RPM: 206 foot lbs. minimum

Emissions: Compliant with EPA Final Tier 4/EU Stage V

Four cylinders

Powertrain:

Hydrostatic with infinitely variable speed control over full range of operating speeds. 2 speed ranges, joystick mounted F-N-R, acceleration pedal.

Axes: Fixed, 100% differential, manually engaged front axle, fixed conventional differential rear axle or oscillating rear axle

Max rise and fall single wheel: 15 inches maximum, 14 inch minimum

Hydraulically activated, self-adjusting internal wet disc brakes and driveline drum brake

Cooling:

Hydraulically driven, proportionally controlled fan or belt-driven fan

Articulation Angle: 30 degrees each direction

Cylinders: Heat treated chrome plated polished cylinder rods, hardened steel, replaceable bushings and pivot pins

Hydraulics:

Main pump (loader and steering): 18 GPM standard, 29 GPM with high flow option.

Quick Coupling: Conforms with ISO 16028 quick coupling for all attachments

Electrical:

Voltage: 12-volt or 24-volt electrical system

Battery: One (1) 24-volt or two (2) 12-volt

Battery capacity: One (1) 925 CCA or Two (2) 900 CCA

Cab:

Seat: Air ride high back with head rest and dual lumbar support or mechanical suspension seat

Noise: Operator ear 70 dBA, Bystander 101 dBA



GUAM SOLID WASTE AUTHORITY



LOURDES A. LEON GUERRERO
Governor of Guam

TOSHUA F. TENORIO
Deputy Governor of Guam

IRVIN L. SLIKE
General Manager

COMPLY / NON-COMPLI

Air conditioning

Steering: Dual tilt and telescoping steering column

Performance: Conforms with SAE J1040, SAE J231, ISO 3471 and ISO 3449 ROPS/FOPS

Operating Weight:

ISO quick coupler and 1CY general purpose bucket / bolt on edge 12,250 lbs. minimum

1.4 CY multi-purpose bucket: 12,800 lbs. maximum

Wheelbase: 7 feet minimum

Dump clearance: 40-degree full height – 8 feet 3 inches

Reach: 40-degree full height – 32 inches

Fork height fully raised: 10 feet minimum

Fork tipping load straight: 7000 lb. maximum

Attachments:

ISO quick coupling mechanism: Conforms with ISO 16028

One (1) additional 1.4 CY bucket with bolt on edge

One (1) Tink claw bucket model 520 or equal

One (1) 60-inch pick-up broom: 800 lb. minimum; 900 lb. max

One (1) Fork: 48 inches minimum

Equipment Warranty:

The Bidder guarantees to the Purchaser that the equipment, upon delivery, will be brand new and will have been constructed using entirely new components. Furthermore, the Bidder assures that any new equipment provided shall be free from any defects in manufacturing workmanship and materials for a duration of 24 months or 2,000 hours, whichever occurs first, commencing from the date of equipment delivery. This warranty encompasses any necessary repairs or replacements without any additional cost to the Purchaser.

Miscellaneous Items:

One (1) operator's manual hardcopy

One (1) operator's manual on CD

One (1) complete illustrated parts book

One (1) shop repair manual

One (1) warranty manual

Manufacturer's training of GSWA crew (8 hours) & contracted mechanics (20 hours)

Online manual for parts, service & repair



GUAM SOLID WASTE AUTHORITY



LOURDES A. LEON GUERRERO
Governor of Guam

JOSHUA F. TENORIO

TRVIN L. SLIKE
General Manager

Delivered with a full tank of fuel _____

Note: The GSA Federal Contract will be considered along with its terms and conditions if offered.

Bidding On:

Manufacturer: _____

Year: _____

Model: _____

Place of Origin: _____

Date of Delivery: _____

Date/Time 11-22-2023 01:14:18 p.m. Transmit Header Text
Local ID 1 6714734370 Local Name 1 PUI

This document : Confirmed
(reduced sample and details below)
Document size : 8.5"x11"



GUAM SOLID WASTE AUTHORITY

LOURDES A. LEON GUERRERO
Governor of Guam

JOSHUA P. TENORIO
Governor of Guam

IRVIN L. SLIKE
General Manager



November 20, 2023

INVITATION FOR BID
GSWA-004-24

COMPACT WHEEL LOADER W/ ATTACHMENTS

AMENDMENT NO. 2

1. Amend page 31 of 34

From:
Deadline for Receipt of Written Questions **Wednesday, November 15, 2023**
must be e-mailed to the Guam Solid Waste Authority at **on or before 5:00PM**
procurement@gswa.guam.gov, ATTN: General Manager **Chamorro Standard Time**

To Now Read:
Deadline for Receipt of Written Questions **Tuesday, November 21, 2023**
must be e-mailed to the Guam Solid Waste Authority at **on or before 5:00PM**
procurement@gswa.guam.gov, ATTN: General Manager **Chamorro Standard Time**

2. Amend page 31 of 34

From:
Bid Due Date & Bid Opening at the Guam Solid Waste **Wednesday, November 22, 2023**
Authority: Administration Office, GSWA Bldg., 2nd Fl. **at 1:00PM**
546 N. Marine Corps Dr., Tamuning, Guam **Chamorro Standard Time**

To Now Read:
Bid Due Date & Bid Opening at the Guam Solid Waste **Tuesday, November 28, 2023**
Authority: Administration Office, GSWA Bldg., 2nd Fl. **at 1:00PM**
546 N. Marine Corps Dr., Tamuning, Guam **Chamorro Standard Time**

3. Amend to replace pages 32 of 34 through 34 of 34 with the "Revised 11/20/2023 Page 32" through "Revised 11/20/2023 Page 34" attached.

*All others remain the same.

Irvin L. Slike
Irvin L. Slike,
General Manager

ACKNOWLEDGEMENT RECEIPT	
Return to GSWA by original or fax.	
Received by:	<i>Ryan Paul Santos</i>
Date:	<i>11/20/23</i>
Company Name:	<i>Forrest Equipment Co. LLC</i>
Fax to: 671 649 3777	
Email: procurement@gswa.guam.gov	

546 N. MARINE CORPS DRIVE, TAMUNING, GU 96913 * TEL: 671-646-3111 | FAX: 671-649-3777
<https://www.guamsolidwasteauthority.com/>

Total Pages Scanned : 4

Total Pages Confirmed : 4

No.	Job	Remote Station	Start Time	Duration	Pages	Line	Mode	Job Type	Results
001	306	6716493777	01:12:52 p.m. 11-22-2023	00:00:49	4/4	1	EC	HS	CP28800

Abbreviations:

HS: Host send	PL: Polled local	MP: Mailbox print	CP: Completed	TS: Terminated by system
HR: Host receive	PR: Polled remote	RP: Report	FA: Fail	G3: Group 3
WS: Waiting send	MS: Mailbox save	FF: Fax Forward	TU: Terminated by user	EC: Error Correct



November 20, 2023

**INVITATION FOR BID
GSWA-004-24
COMPACT WHEEL LOADER W/ ATTACHMENTS**

Questions and Concerns received from Morrico Equipment on November 15, 2023

1. Axles: Fixed, 100% differential, manually engaged front axle, fixed conventional differential rear axle. Is an oscillating rear axle acceptable?

Response: Yes, refer to Amendment No. 2.

2. Max rise and fall single wheel: 15 inches maximum, 14 inches minimum. Please clarify what is required by the term listed above.

Response: The term "Max rise and fall single wheel: 15 inches maximum, 14 inches minimum" pertains to the vertical movement capability of a single wheel on the compact wheel loader. Here's a breakdown of the requirement:

- **Max Rise:** This refers to the maximum vertical distance the center of a single wheel is allowed to move upward from its resting position. In this context, the specified maximum rise is 15 inches.
- **Min Fall:** Conversely, the minimum fall denotes the minimum vertical distance the center of a single wheel is permitted to move downward from its resting position. For this specification, the minimum fall is 14 inches.

These parameters are crucial for ensuring that the compact wheel loader can effectively navigate varied terrains, accommodate different load sizes, and maintain stability during operation.

3. Hydraulically Driven, proportionally controlled fan. Will a belt driven fan be acceptable?

Response: Yes, refer to Amendment No. 2.

4. Voltage: 12-volt. Will a 24 Volt Electrical System be acceptable?

Response: Yes, refer to Amendment No. 2.

5. One (1) Battery. Will two 12-volt batteries be acceptable?

Response: Yes, refer to Amendment No. 2.

6. Battery Capacity: 925 CCA. Will two batteries with 900 CCA be acceptable?

Response: Yes, refer to Amendment No. 2.



GUAM SOLID WASTE AUTHORITY

LOURDES A. LEON GUERRERO
Governor of Guam

JOSHUA F. TENORIO
Lieutenant Governor

IRVIN L. SLIKE
General Manager



7. Seat: Air Ride high back with head rest and dual lumbar support. Will a mechanical suspension seat be acceptable?

Response: Yes, refer to Amendment No. 2.

8. 1.4 CY Bucket: 12,800 lbs. Maximum. Please confirm if this bucket request is for a multipurpose bucket.

Response: Refer to Amendment No. 2.

9. One (1) 1.4 CY Bucket with Bolt on Cutting Edge. Please confirm if this bucket request is for a Multipurpose Bucket. Please confirm if this is bucket request is additional to Question 8 bucket request or the same request.

Response: Refer to Amendment No. 2.

Questions and Concerns received from Far East Equipment Co. on November 17, 2023

10. The manufacturer of the Tink Claw bucket does not recommend the C720 (2.7CYD) model for this size machine. They recommend the C520 (1.2CYD) model for a machine of this size. With this information, does GSWA want to proceed with a C720 model bucket though it may pose a tipping hazard?

Response: No, refer to Amendment No. 2.

Irvin L. Slike,
General Manager

ACKNOWLEDGEMENT RECEIPT	
Return to GSWA by email or fax.	
Received By	Ryne Paul Santos
Date:	11/22/23
Company Name	Far East Equipment Co. LLC
Fax to: 671 649 3777	
Email: procurement@gswa.guam.gov	

Date/Time 11-22-2023 01:13:02 p.m. Transmit Header Text
Local ID 1 6714734370 Local Name 1 PUI

This document : Confirmed
(reduced sample and details below)
Document size : 8.5"x11"



GUAM SOLID WASTE AUTHORITY

LOURDES A. LEON GUERRERO
Governor of Guam

JOSHUA F. TENORIO
Lt. Governor of Guam

IRVIN L. SUAREZ
Deputy Director



November 20, 2023

INVITATION FOR BID
GSWA-004-24

COMPACT WHEEL LOADER W/ ATTACHMENTS

Questions and Concerns received from Morrico Equipment on November 15, 2023

1. Axles: Fixed, 100% differential, manually engaged front axle, fixed conventional differential rear axle. Is an oscillating rear axle acceptable?

Response: Yes, refer to Amendment No. 2.

2. Max rise and fall single wheel: 15 inches maximum, 14 inches minimum. Please clarify what is required by the term listed above.

Response: The term "Max rise and fall single wheel: 15 inches maximum, 14 inches minimum" pertains to the vertical movement capability of a single wheel on the compact wheel loader. Here's a breakdown of the requirement:

- **Max Rise:** This refers to the maximum vertical distance the center of a single wheel is allowed to move upward from its resting position. In this context, the specified maximum rise is 15 inches.
- **Min Fall:** Conversely, the minimum fall denotes the minimum vertical distance the center of a single wheel is permitted to move downward from its resting position. For this specification, the minimum fall is 14 inches.

These parameters are crucial for ensuring that the compact wheel loader can effectively navigate varied terrains, accommodate different load sizes, and maintain stability during operation.

3. Hydraulically Driven, proportionally controlled fan. Will a belt driven fan be acceptable?

Response: Yes, refer to Amendment No. 2.

4. Voltage: 12-volt. Will a 24 Volt Electrical System be acceptable?

Response: Yes, refer to Amendment No. 2.

5. One (1) Battery. Will two 12-volt batteries be acceptable?

Response: Yes, refer to Amendment No. 2.

6. Battery Capacity: 925 CCA. Will two batteries with 900 CCA be acceptable?

Response: Yes, refer to Amendment No. 2.

546 N. MARINE CORPS DRIVE, TAMUNING, GU 96913 * TEL: 671-646-3111 | FAX: 671-649-3777
<https://www.guamsolidwasteauthority.com/>

Total Pages Scanned : 2

Total Pages Confirmed : 2

No.	Job	Remote Station	Start Time	Duration	Pages	Line	Mode	Job Type	Results
001	305	6716493777	01:12:10 p.m. 11-22-2023	00:00:27	2/2	1	EC	HS	CP28800

Abbreviations:

HS: Host send PL: Polled local MP: Mailbox print CP: Completed TS: Terminated by system
HR: Host receive PR: Polled remote RP: Report FA: Fail G3: Group 3
WS: Waiting send MS: Mailbox save FF: Fax Forward TU: Terminated by user EC: Error Correct



GUAM SOLID WASTE AUTHORITY

LOURDES A. LEON GUERRERO

JOSHUA F. TENORIO

IRVIN L. SLIKE



November 14, 2023

INVITATION FOR BID GSWA-004-24 COMPACT WHEEL LOADER W/ ATTACHMENTS

AMENDMENT NO. 1

1. Amend page 31 of 34

From:

Deadline for Receipt of Written Questions must be e-mailed to the Guam Solid Waste Authority at procurement@gswa.guam.gov, ATTN: General Manager

Thursday, November 9, 2023
on or before 5:00PM
Chamorro Standard Time

To Now Read:

Deadline for Receipt of Written Questions must be e-mailed to the Guam Solid Waste Authority at procurement@gswa.guam.gov, ATTN: General Manager

Wednesday, November 15, 2023
on or before 5:00PM
Chamorro Standard Time

2. Amend page 31 of 34

From:

Bid Due Date & Bid Opening at the Guam Solid Waste Authority: Administration Office, GSWA Bldg., 2nd Fl. 546 N. Marine Corps Dr., Tamuning, Guam

Monday, November 20, 2023
at 1:00PM
Chamorro Standard Time

To Now Read:

Bid Due Date & Bid Opening at the Guam Solid Waste Authority: Administration Office, GSWA Bldg., 2nd Fl. 546 N. Marine Corps Dr., Tamuning, Guam

Wednesday, November 22, 2023
at 1:00PM
Chamorro Standard Time

*All others remain the same.

Irvin L. Slike,
General Manager

ACKNOWLEDGEMENT RECEIPT	
Return to GSWA by email or fax	
Received By	Ryne Paul Santos
Date	11/14/23
Company Name	Far East Equipment Co. LLC
Fax to: 671-649-3777	
Email: procurement@gswa.guam.gov	



GUAM SOLID WASTE AUTHORITY

LOURDES A. LEON GUERRERO
Supervisor of Finance

JOSHUA F. TENORIO
Supervisor of Operations

IRVIN L. SLIKE
General Manager



November 14, 2023

INVITATION FOR BID GSWA-004-24 COMPACT WHEEL LOADER W/ ATTACHMENTS

Questions and Concerns received from Far East Equipment Co. On November 13, 2023

1. In regards to the high-flow hydraulics requirement for the broom attachment, John Deere's broom attachment does "NOT" require high-flow. Will high-flow still be required?

Response: The hydraulic flow range is typical for brooms.

2. What make and model machine was used to form the specs of this bid?

Response: John Deere model 244P.

Irvin L. Slike,
General Manager

ACKNOWLEDGEMENT RECEIPT	
Return to GSWA by email or fax.	
Received By	Ryne-Paul Santos
Date	11/14/22
Company Name	Far East Equipment Co. LLC
Fax to: 671 649 3777	
Email: procurement@gswa.guam.gov	



GUAM SOLID WASTE AUTHORITY

LOURDES A. LEON GUERRERO
Governor of Guam

JOSHUA F. TENORIO
Lt. Governor of Guam

IRVIN L. SLIKE
General Manager



November 13, 2023

INVITATION FOR BID GSWA-004-24 COMPACT WHEEL LOADER W/ ATTACHMENTS

Questions and Concerns received from Far East Equipment Co. On November 9, 2023

1. In the specs under Powertrain, the spec reads "Max rise and fall single wheel: 15 inch maximum, 14 inch minimum." Will 10 inches be acceptable?

Response: No, specs remain the same.

2. In the specs under Cooling, the spec reads "Hydraulically driven, proportionally controlled fan." Will direct driven be acceptable?

Response: No, specs remain the same.

3. In the specs under Hydraulics, the spec reads "Main pump (loader and steering): 18 GPM standard, 29 GPM with high flow option." Will a max rated flow 21.13 GPM @ 1,000 PSI be acceptable?

Response: No, specs remain the same.

4. In the specs under Hydraulics, the spec reads "Main pump (loader and steering): 18 GPM standard, 29 GPM with high flow option." Can you clarify why there is a request for high flow option when the requested documents do not require high flow hydraulics?

Response: The pick-up broom specified requires the flow specified.

5. In the specs under Electrical, the spec reads "Battery capacity: 925 CCA." Will 830 CCA be acceptable?

Response: No, specs remain the same.

Irvin L. Slike,
General Manager

ACKNOWLEDGEMENT RECEIPT	
Return to GSWA by email or fax.	
Received By:	Ryno-Paul Santos <i>[Signature]</i>
Date:	11/13/23
Company Name:	Far East Equipment Co. LLC
Fax to: 671 649 3777	
Email: procurement@gswa.guam.gov	

PROTESTS

ROBERTS FOWLER & VISOSKY LLP
ATTORNEYS AT LAW

TIM ROBERTS
KEVIN J. FOWLER
JON A. VISOSKY
SETH FORMAN

855 SOUTH MARINE CORPS DRIVE, SUITE 201
TAMUNING, GUAM 96913
TELEPHONE: (671) 646-1222
FACSIMILE: (671) 646-1223
www.guamlawoffice.com

Of Counsel:
MELINDA S. SWAVELY
DAVID W. DOOLEY

Writer's Direct Email:
fowler@guamlawoffice.com

December 27, 2023

PROCUREMENT PROTEST

VIA FACSIMILE TRANSMISSION
and HAND DELIVERY

Irvin L. Slike
General Manager
GUAM SOLID WASTE AUTHORITY
546 North Marine Corps Drive
Tamuning, Guam 96913



**Guam Solid Waste Authority
Procurement**

Date Received: 12/27/2023
Time Received: 2:48pm
Received By: C. Aguin

RE: GSWA-004-24: 24 Compact Wheel Loader with Attachments

Dear Mr. Slike,

This office represents Morrico Equipment, LLC ("Morrico"), 197 Ypao Road, Tamuning, Guam 96913, with respect to GSWA-004-24, a procurement solicitation for a Compact Wheel Loader with Attachments (the "IFB"). Morrico hereby files its protest with respect to the IFB. The reasons for this protest are as follows.

The Guam Solid Waste Authority ("GSWA"), let the subject IFB on November 3, 2023. Morrico submitted its bid on the IFB offering a Case 221F Loader. However, in a "Bid Status" received by Morrico on December 13, 2023, the GSWA rejected the Morrico bid due to "Non-conformance with the specifications." The GSWA did not note which specification Morrico failed to meet. Morrico submitted a Deviation Letter with its bid. The GSWA specifications and Morrico's deviations thereto are as follows:

1) GSWA Specification:

Powertrain: Max rise and fall single wheel: 15 inches maximum, 14 inch minimum.

Morrico Deviation:

Morrico has a rise and fall single wheel of 11.8 inches for Case 221F Loader.

2) GSWA Specification:

Cooling: Hydraulically activated, self-adjusting internal wet disc brakes and driveline drum brake.

Morrice Deviation:

Has a fan directly connected to the engine for Case 221F Loader.

3) GSWA Specification:

Operating Weight: 1.4 CY multi-purpose bucket: 12,800 lbs. maximum.

Morrice Deviation:

Has 1.38 CY multi-purpose bucket.

4) GSWA Specification:

One (1) additional 1.4 CY bucket with bolt on edge.

Morrice Deviation:

Werk Brau supplies a 1.25 CY General Purpose Bucket.

5) GSWA Specification:

One (1) 60-inch pick-up broom: 800lb. minimum; 900 lb. max.

Morrice Deviation:

Smallest pick-up sweeper has a weight of 946 pounds.

6) GSWA Specification:

One (1) operator's manual on CD.

Morrice Deviation:

Will supply a copy of the Operator's Manual on a USB Drive.

7) GSWA Specification:

One (1) Warranty Manual.

Morrice Deviation:

Case does not provide a warranty manual.

8) GSWA Specification:

Online manual for parts, service & repair.

Morrigo Deviation:

This is a dealer only item. Only dealers are permitted to access the dealer portals. A digital copy of the parts, service, and repair manual will be supplied.

As noted above, GSWA did not advise Morrigo which of the foregoing deviations it relied on to reject Morrigo's bid.

However, Morrigo was not able to offer a product that met all specifications of the IFB, which is understandable since it cannot offer the John Deere 244P make and model on which GSWA based its specifications. In response to a question from Far East Equipment Company, LLC, GSWA advised that it based its specifications on a particular make and model of a compact loader, the "John Deere model 244P." But GSWA cannot restrictively apply the specifications of a particular manufacturer's product. Paragraph 19 of the IFB's General Terms and Conditions, provides as follows:

BRAND NAMES: Any reference in the Solicitation to manufacturer's Brand Names and number is due to lack of a satisfactory specification of commodity description. Such preference is intended to be descriptive, but not restrictive and for the sole purpose of indicating to prospective bidders a description of the article or services that will be satisfactory. Bids on comparable items will be considered provided the bidder clearly states in his bid the exact articles he is offering and how it differs from the original specification.

This "Brand Names" clause of the IFB's General Terms and Conditions, is an implementation of the provisions of 2 GAR § 4103(b)(2)(b), governing the use of brand names in specification development. But these regulations do not allow the application of brand name specifications in a restrictive manner. Instead, the specifications must be construed as descriptive only and must allow for the consideration for award of any substantially equivalent product. 2 GAR § 4103(b)(2)(b)(iii). The use of brand name specifications cannot be allowed to restrict competition. 2 GAR § 4103(b)(2)(b)(v).

5 GCA § 5265 provides that: "All specifications shall seek to promote overall economy for the purposes intended and encourage competition in satisfying the Territory's needs, and shall not be unduly restrictive." In addition, 5 GCA § 5268(a) provides that: "Specifications shall not include requirements, such as but not limited to restrictive dimensions, weights or materials, which unnecessarily restrict competition, and shall include only the essential physical characteristics and functions required to meet the Territory's minimum needs." An agency should avoid specifications

peculiar to one manufacturer and, instead, should develop specifications that "describe the salient technical requirements or desired performance characteristics of supplies or services to be procured without including restrictions which do not significantly affect the technical requirements or performance characteristics." 5 GCA § 5268(b) and (c).

The GSWA's application of the John Deere 244P specifications in a restrictive manner is in violation of the foregoing regulations and statutes. Restrictive application of the John Deere 244P specifications here has reduced competition, and will result in a tremendous increase in costs to the Territory. This is because the product that Morrico bid was \$47,000 less expensive than the John Deere 244P offered by Far East Equipment. The minimum needs to be met by the GSWA are those that any loader would fulfill, and the loader offered by Morrico meets those basic needs.

Accordingly, based on the foregoing, Morrico respectfully requests that the GSWA accept the lesser priced loader offered by Morrico. Please be advised that pursuant to 5 G.C.A. § 5425, ~~you are not to proceed further with the procurement or award of a procurement contract prior to resolution of this bid protest.~~

Sincerely,

ROBERTS FOWLER & VISOSKY, LLP

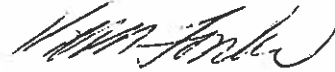

Kevin J. Fowler



GUAM SOLID WASTE AUTHORITY



LOURDES A. LEON GUERRERO
Governor of Guam

JOSHUA F. TENDRIO
Lt. Governor of Guam

IRVIN L. SLIKE
General Manager

April 5, 2024

VIA HAND DELIVERY

Kevin J. Fowler, Esq.
Robert Fowler & Visosky, LLP
865 South Marine Corps Drive, Suite 201
Tamuning, Guam 96913

ROBERTS FOWLER & VISOSKY LLP
Date: April 5, 2024
Time: 10:45
Sign: N. Ericsson

**Re: Protest by Morrico Equipment LLC to GSWA Invitation to Bid
No. GSWA-004-24 for Compact Wheel Loader with Attachments**

Dear Mr. Fowler:

This is in response to your letter dated December 27, 2023, protesting the procurement of a Compact Wheel Loader published in IFB GSWA-004-24. The protest alleges that (1) Morrico's bid was rejected due to "non-conformance with the specifications" without advising which specification Morrico failed to meet and (2) GSWA restrictively applied the specifications of a particular manufacturer's product.

For the reasons set forth below, GSWA denies Morrico's protest.

Morrico's protest is untimely.

Morrico submitted its protest after the statutory deadline. Guam's procurement law requires a written protest be submitted within fourteen (14) days after the aggrieved bidder knows or should have known the facts giving rise to the protest. 5 GCA § 5425.

On November 14, 2023, GSWA informed all bidders, including Morrico, that the John Deere model 244P was the make/model machine GSWA used to form the basis for some IFB specifications. Morrico did not submit its written protest until Jan 2, 2024, more than 14 days from the date it was made aware that GSWA cited John Deere model 244P as its source for some of the IFB's specifications. Therefore, Morrico's protest is untimely and denied.

GSWA's IFB did not solicit a brand name product and was not unduly restrictive.

Even though Morrico's protest is denied for being untimely, GSWA also denies Morrico's allegation that the IFB solicited a brand name product. First, the IFB did not use any brand



GUAM SOLID WASTE AUTHORITY

LOURDES A. LEON GUERRERO
Governor of Guam

JOSHUA F. TENORIO
Lt. Governor of Guam

IRVIN L. SLIKE
General Manager



names in the specifications. Furthermore, as noted in your protest, the IFB provided that any reference to a manufacturer's brand name is intended to be descriptive but not restrictive.

The procurement record shows that GSWA sought a Compact Wheel Loader with horsepower and weight similar to a John Deere 244/P. Other manufacturers such as Case, Ford, and Volvo make units of similar size that perform similarly.

Furthermore, GSWA developed these specifications to meet the agency's needs in the best interests of Guam. The rise and fall of wheels is a measurement spec that other manufacturers such as Case, Volvo, and Caterpillar can meet. The wheel deflection is needed to get curb clearance in Guam's terrain. Based on experience, the type of waste GSWA would handle to ~~clean up illegal dump sites and green waste such as dust, paper, and plastic can clog a radiator.~~ Green waste such as brush, leaves, and branches is extremely dusty when ground up, and fine particles can clog radiators. Therefore, the specifications also requested a loader with a reversible hydraulic fan to reverse flow to maintain engine coolant temperature. Again, there are several manufacturers that offer products that could have met the IFB specifications.

The specifications are not restrictive and seek a machine that meets GSWA's needs. The specifications do not refer to a brand name and can be met by different vendors. Therefore, the IFB did not restrictively procure a specific manufacturer's product and would deny the protest on that basis too.

Morrigo's bid failed to meet the IFB requirements.

Instead of submitting a bid that met the IFB specifications, Morrigo submitted a bid that included several "deviations". An IFB is awarded "to the lowest responsible and responsive bidder" whose bid meets the requirements and criteria set forth in the IFB. 5 GCA § 5211(g) and 2 GAR Div 4 § 3109(n)(1). A responsive bidder is a bid that conforms in all material respects to the IFB. 5 GCA § 5201(g) and 2 GAR Div 4 § 3109(n)(2). Any offer that does not meet the acceptability requirements must be rejected as nonresponsive. 2 GAR Div 4 §§ 3109(n)(3), 3115(3)(3)(A)(ii). Morrigo admitted in its bid that the product offered failed to meet the IFB requirements. This resulted in Morrigo offering a product smaller than what is needed to perform the necessary functions and unable to perform well in the anticipated environment of use. Because Morrigo's bid failed to meet the IFB's requirements, GSWA appropriately rejected the bid as nonresponsive.

Morrigo did not request a reason for rejection, but Morrigo also submitted a bid that it conceded failed to meet the specifications. Morrigo knew or should have known that its failure to offer a product that met the IFB specifications was grounds for rejection.

Kevin J. Fowler, Esq.
Morrigo Protest of IFB GSWA-004-24
Page 4



GUAM SOLID WASTE AUTHORITY



LOURDES A. LEON GUERRERO
Governor of Guam

JOSHUA F. TENORIO
Lt. Governor of Guam

IRVIN L. SILKE
General Manager

Conclusion.

GSWA denies Morrico's protest for untimeliness but also denies Morrico's claim that the IFB improperly used a brand name in favor of a particular vendor. Morrico has the right to administrative and judicial review of this decision, denying the protest.

A handwritten signature in black ink, appearing to read 'I. Silke', is positioned above the printed name of the General Manager.

IRVIN L. SILKE
General Manager

Kevin J. Fowler, Esq.
Morrico Protest of IFB GSWA-004-24
Page 4

DETERMINATIONS



GUAM SOLID WASTE AUTHORITY

LOURDES A. LEON GUERRERO JOSHUA F. TENORIO
Governor of Guam Lt. Governor of Guam

IRVIN L. SLIKE
General Manager



October 18, 2023

MEMORANDUM

To: Irvin Slike, General Manager
CC: Procurement File
From: Alicia Fejeran, Chief of Administration
Subject: **Determination of Need Re: Compact Wheel Loader**

This Determination of Need is issued pursuant to 5 GCA § 5249 (e) and 2 GAR, Div. 4, §3114(c), which require a written determination of need justifying the use of competitive selection procedures.

Under 10 GCA Chapter 51A, Guam Solid Waste Authority (GSWA) shall organize, plan for, and secure and manage resources and promote the implementation of the Solid Waste Management Plan and evaluate and promote capital improvements and maintenance programs to the solid waste management system.

Guam Solid Waste Authority (GSWA) intends to release an invitation for bid for the procurement of a compact wheel loader with attachments, thus eliminating the need to continually rent such equipment from external rental companies. Several reasons for purchasing a compact wheel loader include cost efficiency, operational efficacy, and the fulfillment of our core responsibilities in managing solid waste services on the island.

GSWA would utilize this equipment for offloading trash carts from shipment containers, loading and offloading 55-gallon drums in Operations and the HHW Facility, cleaning debris around the compound and transfer stations, and eventually assisting DPW in cleaning up illegal dump sites.

An inquiry was submitted to the local General Services Agency on October 18, 2023 to confirm that the item was not available in the Government of Guam's inventory.

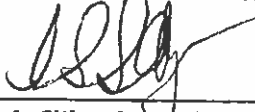
Irvin L. Slike, General Manager

10/18/23
Date